



BIDDING DOCUMENTS

FOR

**(1) Rechargeable Battery 6V (2) Dry Charged Battery 12V – 200N 200 AH
(As per BOQ/Specifications)**

NOTE:

1. Sign & Stamp on all pages dully filled by bidder

Single Stage One Envelope Procedure

The earnest money of un-successful bidders will be returned after 5 days of posting of Final Evaluation Report on EPADS and PPRA.

Purchase Department, Pakistan Security Printing Corporation (Pvt.) Ltd
Jinnah Avenue, Malir Halt, Karachi-Pakistan,
Phone: (92-21)-99248511-15, Facsimile :(92-21)-99248534
email: Purchase.local@pspc.gov.pk, website: www.pspc.gov.pk



Preface

Rule 23 of Public Procurement Rules requires procuring agencies to formulate bidding documents that shall be made available to the bidders immediately after the publication of the invitation to bid.

Document comprises of the Sections listed below:

PART-A – BIDDING PROCEDURE & REQUIREMENTS

Section I	Invitation to Bids
Section II	Instructions to Bidders (ITB)
Section III	Bid Data Sheet (BDS)
Section IV	Eligible Countries
Section V	Technical Specifications, Schedule of Requirements
Section VI	Standard Forms

PART-B – CONDITIONS OF CONTRACT AND CONTRACT FORMS

Section VII	General Conditions of Contract (GCC)
Section VIII	Special Conditions of Contract (SCC)
Section IX	Contract Forms
	Integrity Pact



BIDDING DOCUMENTS FOR THE PROCUREMENT OF FOLLOWING
_(1) Rechargeable Battery 6V (2) Dry Charged Battery 12V – 200N 200 AH
(As per BOQ/Specifications)

PART-A – BIDDING PROCEDURE & REQUIREMENTS

Section I - Invitation to Bids

Section II- Instructions to Bidders (ITB)

This Section provides information to help Bidders prepare their Bids. Information is provided for the submission, opening, and evaluation of Bids and for the award of Contract.

Section III- Bid Data Sheet (BDS)

This Section includes provisions specific to procurement and to supplement Section-II, Instructions to Bidders.

Section IV - Eligible Countries

This Section contains information regarding eligible countries.

Section V - Technical Specifications, Schedule of Requirements

This Section includes the details of specifications for the goods and ancillary services to be procured and schedule of requirements.

Section VI - Standard Forms

This Section includes the standard forms for the Bid Submission, Price Schedules, and Bid Security etc. These forms are to be completed and submitted by the Bidder as part of Bid.

PART-B – CONDITIONS OF CONTRACT AND CONTRACT FORMS

Section VII - General Conditions of Contract (GCC)

This Section includes the general clauses to be applied in all the contracts.

Section VIII - Special Conditions of Contract (SCC)

This Section consists of Contract Specific general and special conditions.

Section IX - Contract Forms

This Section contains forms which, once completed, will become part of the Contract. The forms for **Performance Security** will be submitted by the successful bidder to whom Purchase Order is issued, before the award of contract.

Integrity Pact

The successful bidder shall be required to furnish Integrity Pact as per the attached format.



PART-A
BIDDING PROCEDURE & REQUIREMENTS

SECTION I: INVITATION TO BIDS





Pakistan Security Printing Corporation (Pvt.) Ltd INVITATION TO e-BIDS

Invitation No. Tender # LP/T-2406/26/NB

Date: April 13, 2026

1. This Invitation to e-Bids follows the Procurement Advertisement (PA) No. Tender # LP/T-2406/26/NB for the **(1) Rechargeable Battery 6V (2) Dry Charged Battery 12V – 200N 200 AH (As per BOQ/Specifications)**
2. The Pakistan Security Printing Corporation (Pvt.) Ltd (PSPC) has reserved the funds for the procurement planned during the financial year 2025-26. It is intended that part of the proceeds of the fund will be used to cover eligible payment under the contract for the procurement.
3. PSPC now invites bids from eligible manufacturer / contractors / suppliers for the **(1) Rechargeable Battery 6V (2) Dry Charged Battery 12V – 200N 200 AH (As per BOQ/Specifications)**
4. The supplier must meet the following eligibility criteria:
 - I. *This invitation for Bids is open to all reputed manufacturer / contractors / suppliers.*
 - II. *Bidders should not be under a declaration of ineligibility for corrupt and fraudulent practices issued by any Government (Federal, Provincial), a local body and international or a public sector organization.*
 - III. *They must be registered with tax authorities and are active tax payers.*
 - IV. *The bidder must meet all the terms and conditions given in Technical Specifications and BOQ of this Tender Document.*
 - V. *The bidder and their deputed staff must submit an undertaking to comply with PSPC's Code of Conduct, using the prescribed format provided in the tender document.*
 - VI. *The bidder must submit an undertaking to comply with all applicable HSE laws, regulations and industry standards; and with all HSE requirements of PSPC, using the prescribed format provided in the tender document.*
 - VII. *Where an experience certificate is required under any tender, the same must be issued strictly in the name of the bidder. Experience certificates issued in the name of any other individual, firm, affiliate, joint venture partner, or obtained through sub-letting, subcontracting, or any similar arrangement shall not be acceptable.*
 - VIII. *Any regular employee, contractual, or outsourced/third-party resource who are currently or were previously deputed on PSPC assignments during last 5 years are **not authorized** to participate in the bidding process for next 3 years either as a bidder or as a representative of any bidder/vendor. PSPC reserves the right to reject such bids at any stage of the procurement process.*
5. The bidding shall be conducted in line with the Single Stage One Envelope Procedure of the Public Procurement Rules 2004 and any Regulations, Regulatory Guides, Procurement Guidelines or Instructions issued by the Authority (from time to time) and is open to all potential bidders.
6. The Bid Security/Earnest Money amounting to **Rs. 36,000/-** (Fixed) must be in the shape of pay order / demand draft (cheque will not be entertained) in favor of "Pakistan Security Printing Corporation (Pvt.) Ltd.". or in the form of an unconditional Bank Guarantee enforceable in Pakistan, or insurance guarantee (PACRA Rating "AAA, AA++"). The document of bid security will be subject to verification.



7. The scanned copy of Bid Security/Earnest Money should be uploaded via EPADS, while the original must be sent to the PSPC Purchase Department at the address provided below. It is mandatory that the original Bid Security is received before the bid submission deadline. Non-receipt of original Bid security before the bid submission deadline will lead to rejection of bid then & there. *In case any samples are required the same be submitted along with bid security. (If applicable)*
8. Tender advertisement can be viewed on the Newspapers, PPRA and PSPC websites (www.ppra.org.pk and www.pspc.gov.pk), whereas the complete tender document containing a detailed description of the assignment and other terms and conditions is available on EPADS at www.eprocure.gov.pk
9. Electronic bids prepared in accordance with the instruction provided in tender document must be submitted by using EPADS (uploading method) on or before **Thursday, April 30, 2026. 11:00 A.M.** Manual bids will not be accepted. The e-bids will open on same day at **11: 30 AM** using EPADS.

Deputy General Manager
Purchase Department
Pakistan Security Printing Corporation (Pvt) Ltd
Jinnah Avenue Malir Halt, Karachi - 75100
Ph: 021-99248511 (Ext - 2201-19) / purchase.local@pspc.gov.pk
www.pspc.gov.pk



BIDDER DETAIL

1.	BRIEF DESCRIPTION OF GOODS / JOBS & QUANTITY:	
2.	NAME OF BIDDER	
3.	ADDRESS	
4.	GST NO.	
5.	NTN NO.	
6.	NAME OF AUTHORIZED PERSON	
7.	DESIGNATION	
8.	TELEPHONE	
9.	FAX	
10.	CELL NO.	
11.	EMAIL ADDRESS	
12.	NAME & ADDRESS OF PRINCIPAL, IF ANY	
13.	PHONE NO. OF PRINCIPAL	

BID SUBMITTED BY

Company Seal _____

Signature _____

Date _____

Name _____

Designation _____



Checklist for Tender “Single Stage One Envelop”

To ensure compliance of following condition before submitting the tender documents at PSPC:

Sr. No.	Description	Yes/No	Initial of Bidder
1.	Complete tender documents have been read thoroughly and understood		
2.	Complete tender documents duly filled in and each page signed and stamp and submitted through EPADS (via uploading method)		
3.	Bid security (Rs. 36,000/- Fixed)		
4.	Sample (if applicable sent along with bid security before bid opening)		
5.	Period of Bid validity is 60 days from bid opening date		
6.	Delivery Schedule (within 30 days from the date of award of Contract)		
7.	Liquidated Damages		
8.	Payment conditions/terms are agreed		
9.	Arbitration		
10.	Signing of Contract		
11.	General Terms & Conditions		

BIDDER MUST RETURN ALL PAGES OF TENDER DOCUMENT DULY SIGNED & STAMPED ON EACH PAGE AT THE TIME OF SUBMISSION OF BID THROUGH EPADS (via uploading method).



Table of Contents

SECTION I: INVITATION TO BIDS	4
SECTION II: INSTRUCTION TO BIDDERS (ITBs)	10
SECTION III: BID DATA SHEET	49
SECTION IV: ELIGIBLE COUNTRIES	56
SECTION V: SCHEDULE OF REQUIREMENTS, TECHNICAL SPECIFICATIONS	57
SECTION VI – STANDARD FORMS FOR (SINGLE STAGE ONE ENVELOPE PROCEDURE)	62
SECTION VIII: SPECIAL CONDITIONS OF THE CONTRACT (SCC)	89
SECTION IX: CONTRACT FORMS	95



SECTION II: INSTRUCTION TO BIDDERS (ITBs)



Section II. Instructions to Bidders (ITBs)

<u>A. Introduction</u>	
1. Scope of Application	1.1 The Procuring Agency (PA), as indicated in the Bid Data Sheet (BDS) invites Bids for the equipment and related services as specified in the BDS and Section V – Technical Specifications & Schedule of Requirements. The successful Bidders will be expected to supply and install the equipment within the specified period and timeline(s) as stated in the BDS.
2. Sources of Funds	2.1 Source of funds is referred in Clause-2 of Invitation to Bids.
3. Eligible Bidders	<p>3.1 A Bidder may be natural person, company or firm or public or semi-public agency of Pakistan or of any foreign country, or any combination of them with a formal existing agreement (on Judicial Papers) in the form of a joint venture, consortium, or association. In the case of a joint venture, consortium, or association, all members shall be jointly and severally liable for the execution of the Contract in accordance with the terms and conditions of the Contract. The joint venture, consortium, or association shall nominate a Lead Member as nominated in the BDS, who shall have the authority to conduct all business for and on behalf of any and all the members of the joint venture, consortium, or association during the Bidding process, and in case of award of contract, during the execution of contract.</p> <p>3.2 The appointment of Lead Member in the joint venture, consortium, or association shall be confirmed by submission of a valid Power of Attorney to the Procuring Agency.</p> <p>3.3 Verifiable copy of the agreement that forms a joint venture, consortium or association shall be required to be submitted as part of the Bid.</p> <p>3.4 Any bid submitted by the joint venture, consortium or association shall indicate the part of proposed contract to be performed by each party and each party shall be evaluated (or post qualified if required) with respect to its contribution only, and the responsibilities of each party shall not be substantially altered without prior written approval of the Procuring Agency and in line with any instructions issued by the Authority.</p> <p>3.5 The invitation for Bids is open to all prospective supplier, manufacturers or authorized agents/dealers subject to any provisions of incorporation or licensing by the respective national incorporating agency or statutory body established for that particular trade or business.</p>



	<p>3.6 Foreign Bidders must be locally registered with the appropriate national incorporating body or the statutory body, before participating in the national/international competitive tendering with the exception of such procurements made by the foreign missions of Pakistan. For such purpose the bidder must have to initiate the registration process before the bid submission and the necessary evidence shall be submitted to the procuring agency along with their bid, however, the final award will be subject to the complete registration process.</p> <p>3.7 A Bidder shall not have a conflict of interest. All Bidders found to have a conflict of interest shall be disqualified. A Bidders may be considered to have a conflict of interest with one or more parties in this Bidding process, if they:</p> <ul style="list-style-type: none">a. are associated or have been associated in the past, directly or indirectly with a firm or any of its affiliates which have been engaged by the Procuring Agency to provide consulting services for the preparation of the design, specifications and other documents to be used for the procurement of goods and related services to be procured under this Invitation for Bids.b. have controlling shareholders in common; orc. receive or have received any direct or indirect subsidy from any of them; ord. have the same legal representative for purposes of this Bid; ore. have a relationship with each other, directly or through common third parties, that puts them in a position to have access to information about or influence on the Bid of another Bidder, or influence the decisions of the Procuring Agency regarding this Bidding process; orf. Submit more than one Bid in this Bidding process. <p>3.8 A Bidder may be ineligible if –</p> <ul style="list-style-type: none">a. he is declared bankrupt or, in the case of company or firm, insolvent;b. payments in favor of the Bidder is suspended in accordance with the judgment of a court of law other than a judgment declaring bankruptcy and resulting (in accordance with the national laws) in the total or partial loss of the right to administer and dispose of its property;c. legal proceedings are instituted against such Bidder involving an order suspending payments and which may result, in accordance with the national laws, in a declaration of bankruptcy or in any other situation
--	--



	<p>entailing the total or partial loss of the right to administer and dispose of the property;</p> <p>d. the Bidder is convicted, by a final judgment, of any offence involving professional conduct;</p> <p>e. the Bidder is blacklisted and hence debarred due to involvement in corrupt and fraudulent practices, or performance failure or due to breach of bid securing declaration.</p> <p>f. The firm, supplier and contractor is blacklisted or debarred by a foreign country, international organization, or other foreign institutions for the period defined by them.</p> <p>3.9 Bidders shall provide to the Procuring Agency evidence of their eligibility, proof of compliance with the necessary legal requirements to carry out the contract effectively.</p> <p>3.10 Bidders shall provide such evidence of their continued eligibility to the satisfaction of the Procuring Agency, as the Procuring Agency shall reasonably request.</p> <p>3.11 Bidders shall submit proposals relating to the nature, conditions and modalities of sub-contracting wherever the sub-contracting of any elements of the contract amounting to the more than ten (10) percent of the Bid price is envisaged.</p>
<p>4. Eligible Goods and Related Services</p>	<p>4.1 All the goods and related services to be supplied under the contract shall have their origin in eligible source countries, and all expenditures made under the contract will be limited to such goods and services. For purpose of this Bid, ineligible countries are stated in the section-4 titled as "Eligible Countries".</p> <p>4.2 For purposes of this Clause, "origin" means the place where the goods are mined, grown, cultivated, produced, manufactured, or processed, or through manufacture, procession, or assembly, another commercially recognized article results that differs substantially in its basic characteristics from its imported components or the place from where the related services are/to be supplied.</p> <p>4.3 The nationality of the supplier that supplies and install the goods shall not determine the origin of the goods.</p>



	<p>4.4 To establish the eligibility of the Goods and the related services, Bidders shall fill the country of origin declarations included in the Form of Bid.</p> <p>4.5 If so required in the BDS, the Bidder shall demonstrate that it has been duly authorized by the manufacturer of the goods to deliver in Pakistan (or in respective country in case of procurement by the Pakistani Missions abroad), the goods indicated in its Bid.</p>
5. One Bid per Bidder	<p>5.1 A bidder shall submit only one Bid, in the same bidding process, either individually as a Bidder or as a member in a joint venture or any similar arrangement.</p> <p>5.2 No bidder can be a sub-contractor while submitting a Bid individually or as a member of a joint venture in the same Bidding process.</p> <p>5.3 A person or a firm cannot be a sub-contractor with more than one bidder in the same bidding process.</p>
6. Cost of Bidding	<p>6.1 The Bidder shall bear all costs associated with the preparation and submission of its Bid, and the Procuring Agency shall in no case be responsible or liable for those costs, regardless of the conduct or outcome of the bidding process.</p>
<u>B. Bidding Documents</u>	
7. Contents of Bidding Documents	<p>7.1 The goods required, bidding procedures, and terms and conditions of the contract are prescribed in the Bidding Documents. In addition to the Invitation to Bids, the Bidding Documents which should be read in conjunction with any addenda issued in accordance with ITB 9.2 include:</p> <p>Section I -Invitation to Bids Section II Instructions to Bidders (ITBs) Section III Bid Data Sheet (BDS) Section IV Eligible Countries Section V Schedule of Requirements and Technical Specifications Section VI Standard Forms Section VII General Conditions of Contract (GCC) Section VIII Special Conditions of Contract (SCC)</p>



	<p style="text-align: center;">Section IX Contract Forms</p> <p>7.2 The number of copies to be completed and returned with the Bid is specified in the BDS.</p> <p>7.3 The Procuring Agency is not responsible for the completeness of the Bidding Documents and their addenda, if they were not obtained directly from the Procuring Agency or the signed pdf version from downloaded from the website of the Procuring Agency. However, Procuring Agency shall place both the pdf and same editable version to facilitate the bidder for filling the forms.</p> <p>7.4 The Bidder is expected to examine all instructions, forms, terms and specifications in the Bidding Documents. Failure to furnish all the information required in the Bidding Documents will be at the Bidder's risk and may result in the rejection of his Bid.</p>
<p>8. Clarification of Bidding Documents</p>	<p>8.1 A prospective Bidder requiring any clarification of the Bidding Documents may notify the Procuring Agency in writing or in electronic form that provides record of the content of communication at the Procuring Agency's address indicated in the BDS.</p> <p>8.2 The Procuring Agency will within three (3) working days after receiving the request for clarification, respond in writing or in electronic form to any request for clarification provided that such request is received not later than three (03) days prior to the deadline for the submission of Bids as prescribed in ITB 23.1. However, this clause shall not apply in case of alternate methods of Procurement.</p> <p>8.3 Copies of the Procuring Agency's response will be forwarded to all identified Prospective Bidders through an identified source of communication, including a description of the inquiry, but without identifying its source.</p> <p style="text-align: center;">In case of downloading of the Bidding Documents from the website of PA, the response of all such queries will also be available on the same link available at the website.</p> <p>8.4 Should the Procuring Agency deem it necessary to amend the Bidding Documents as a result of a clarification, it shall do so following the procedure under ITB 9.</p> <p>8.5 If indicated in the BDS, the Bidder's designated representative is invited at the Bidder's cost to attend a pre-Bid meeting at the</p>



	<p>place, date and time mentioned in the BDS. During this pre-Bid meeting, prospective Bidders may request clarification of the schedule of requirement, the Evaluation Criteria or any other aspects of the Bidding Documents.</p> <p>8.6 Minutes of the pre-Bid meeting, if applicable, including the text of the questions asked by Bidders, including those during the meeting (without identifying the source) and the responses given, together with any responses prepared after the meeting will be transmitted promptly to all prospective Bidders who have obtained the Bidding Documents. Any modification to the Bidding Documents that may become necessary as a result of the pre-Bid meeting shall be made by the Procuring Agency exclusively through the use of an Addendum pursuant to ITB 9. Non-attendance at the pre-Bid meeting will not be a cause for disqualification of a Bidder.</p>
<p>9. Amendment of Bidding Documents</p>	<p>9.1 Before the deadline for submission of Bids, the Procuring Agency for any reason, whether at its own initiative or in response to a clarification requested by a prospective Bidder or pre-bid meeting may modify the Bidding Documents by issuing addenda.</p> <p>9.2 Any addendum issued including the notice of any extension of the deadline shall be part of the Bidding Documents pursuant to ITB 7.1 and shall be communicated in writing or in any identified electronic form that provide record of the content of communication to all the bidders who have obtained the Bidding Documents from the Procuring Agency. The Procuring Agency shall promptly publish the Addendum at the Procuring Agency's web page identified in the BDS:</p> <p>Provided that the bidder who had either already submitted their bid or handed over the bid to the courier prior to the issuance of any such addendum shall have the right to withdraw his already filed bid and submit the revised bid prior to the original or extended bid submission deadline.</p> <p>9.3 To give prospective Bidders reasonable time in which to take an addendum/corrigendum into account in preparing their Bids, the Procuring Agency may, at its discretion, extend the deadline for the submission of Bids: Provided that the Procuring Agency shall extend the deadline for submission of Bid, if such an addendum is issued within last three (03) days of the Bid submission deadline.</p>
<p><u>C. Preparation of Bids</u></p>	



10. Language of Bid	10.1 The Bid prepared by the Bidder, as well as all correspondence and documents relating to the Bid exchanged by the Bidder and the Procuring Agency shall be written in the English language unless otherwise specified in the BDS . Supporting documents and printed literature furnished by the Bidder may be in another language provided they are accompanied by an accurate translation of the relevant pages in the English language unless specified in the BDS , in which case, for purposes of interpretation of the Bidder, the translation shall govern.
11. Documents and Sample(s) Constituting the Bid	<p>11.1 The Bid prepared by the Bidder shall constitute the following components: -</p> <ol style="list-style-type: none"> a) Form of Bid and Bid Prices completed in accordance with ITB 14 and 15; b) Details of the Sample(s) where applicable and requested in the BDS. c) Documentary evidence established in accordance with ITB 13 that the Bidder is eligible and/or qualified for the subject bidding process; d) Documentary evidence established in accordance with ITB 13.3(a) that the Bidder has been authorized by the manufacturer to deliver the goods into Pakistan, where required and where the supplier is not the manufacturer of those goods; e) Documentary evidence established in accordance with ITB 12 that the goods and related services to be supplied by the Bidder are eligible goods and services, and conform to the Bidding Documents; f) Bid security or Bid Securing Declaration furnished in accordance with ITB 18; g) Duly Notarized Power of Attorney authorizing the signatory of the Bidder to submit the bid; and h) Any other document required in the BDS <p>11.2 Where a sample(s) is required by a procuring agency, the sample shall be:</p> <ol style="list-style-type: none"> (a) submitted as part of the bid, in the quantities, dimensions and other details requested in the BDS; (b) carriage paid; (c) received on, or before, the closing time and date for the submission of bids; and (d) evaluated to determine compliance with all characteristics listed in the BDS.



	<p>11.3 The Procuring Agency shall retain the sample(s) of the successful Bidder. A Procuring Agency shall reject the Bid if the sample(s)-</p> <ul style="list-style-type: none"> (a) do(es) not conform to all characteristics prescribed in the bidding documents; and (b) is / are not submitted within the specified time clearly mentioned in the Bid Data Sheet. <p>11.4 Where it is not possible to avoid using a propriety article as a sample, a Bidder shall make it clear that the propriety article is displayed only as an example of the type or quality of the goods being Bided for, and that competition shall not thereby be limited to the extent of that article only.</p> <p>11.5 Samples made up from materials supplied by a Procuring Agency shall not be returned to a Bidder nor shall a Procuring Agency be liable for the cost of making them.</p> <p>11.6 All samples produced from materials belonging to an unsuccessful Bidder shall be kept by the Procuring Agency till thirty (30) days from the date of award of contract or exhaust of all the grievance forums (including those pending at Authority's Level or in some Court of Law).</p>
<p>12. Documents Establishing Eligibility of the Goods and Related Services and Conformity to Bidding Documents</p>	<p>12.1 Pursuant to ITB 11, the Bidder shall furnish, as part of its Bid, all those documents establishing the eligibility in conformity to the terms and conditions specified in the Bidding Documents for all goods and related services which the Bidder proposes to deliver.</p> <p>12.2 The documentary evidence of the eligibility of all goods and related services shall consist of a statement in the Price Schedule of the country of origin of the goods and related services offered which shall be confirmed by a certificate of origin issued at the time of shipment.</p> <p>12.3 The documentary evidence of conformity of the goods and related services to the Bidding Documents may be in the form of literature, drawings, and data, and shall consist of:</p> <ul style="list-style-type: none"> a. a detailed description of the essential technical specifications and performance characteristics of the Goods; b. an item-by-item commentary on the Procuring Agency's Technical Specifications demonstrating



	<p>substantial responsiveness of the Goods and Services to those specifications, or a statement of deviations and exceptions to the provisions of the Technical Specifications;</p> <p>c. any other procurement specific documentation requirement as stated in the BDS.</p> <p>12.4 The Bidder shall also furnish a list giving full particulars, including available sources and current prices of goods, spare parts, special tools, etc., necessary for the proper and continuing functioning of the Goods during the period specified in the BDS following commencement of the use of the goods by the Procuring Agency.</p> <p>12.5 For purposes of the commentary to be furnished pursuant to ITB 12.3I above, the Bidder shall note that standards for workmanship, material, and equipment, as well as references to brand names or catalogue numbers designated by the Procuring Agency in its Technical Specifications, are intended to be descriptive only and not restrictive. The Bidder may substitute alternative standards, brand names, and/or catalogue numbers in its Bid, provided that it demonstrates to the Procuring Agency's satisfaction that the substitutions ensure substantial equivalence to those designated in the Technical Specifications.</p> <p>12.6 The required documents and other accompanying documents must be in English. In case any other language than English is used the pertinent translation into English shall be attached to the original version.</p>
<p>13. Documents Establishing the Eligibility and Qualification of the Bidder</p>	<p>13.1 Pursuant to ITB 11, the Bidder shall furnish, as part of its Bid, all those documents establishing the Bidder's eligibility to participate in the bidding process and/or its qualification to perform the contract if its Bid is accepted.</p> <p>13.2 The documentary evidence of the Bidder's eligibility to Bid shall establish to the satisfaction of the Procuring Agency that the Bidder, at the time of submission of its bid, is from an eligible country as defined in Section-4 titled as "Eligible Countries".</p> <p>13.3 The documentary evidence of the Bidder's qualifications to perform the contract if its Bid is accepted shall establish to the satisfaction of Procuring Agency that:</p>



	<p>a) in the case of a Bidder offering deliver the goods under the contract which the Bidder did not manufacture or otherwise produce, the Bidder has been duly authorized by the Manufacturer or producer to deliver the goods in Pakistan;</p> <p>b) The Bidder has the financial, technical, and supply/production capability necessary to perform the Contract, meets the qualification criteria specified in BDS.</p> <p>c) in the case of a Bidder not doing business within Pakistan, the Bidder is or will be (if awarded the contract) represented by an Agent in Pakistan equipped, and able to carry out the Supplier's maintenance, repair, and spare parts-stocking obligations prescribed in the Conditions of Contract and/or Technical Specifications.</p> <p>d) That the Bidder meets the qualification criteria listed in the Bid Data Sheet.</p>
14. Form of Bid	<p>14.1 The Bidder shall fill the Form of Bid furnished in the Bidding Documents. The Bid Form must be completed without any alterations to its format and no substitute shall be accepted.</p>
15. Bid Prices	<p>15.1 The Bid Prices and discounts quoted by the Bidder in the Form of Bid and in the Price Schedules shall conform to the requirements specified below in ITB Clause 15 or exclusively mentioned hereafter in the bidding documents.</p> <p>15.2 All items in the Schedule of requirement must be listed and priced separately in the Price Schedule(s). If a Price Schedule shows items listed but not priced, their prices shall be construed to be included in the prices of other items.</p> <p>15.3 Items not listed in the Price Schedule shall be assumed not to be included in the Bid, and provided that the Bid is still substantially responsive in their absence or due to their nominal nature, the corresponding average price of the respective item(s) of the remaining substantially responsive bidder(s) shall be construed to be the price of those missing item(s):</p> <p>Provided that:</p> <p>a) where there is only one (substantially) responsive bidder, or</p> <p>b) where there is provision for alternate proposals and the respective items are not listed in the other bids,</p> <p>The procuring agency may fix the price of missing items in accordance with market survey, and the same shall be considered as final price.</p>



	<p>15.4 The Bid price to be quoted in the Form of Bid in accordance with ITB 15.1 shall be the total price of the Bid, excluding any discounts offered.</p> <p>15.5 The Bidder shall indicate on the appropriate Price Schedule, the unit prices (where applicable) and total Bid price of the goods it proposes to deliver under the contract.</p> <p>15.6 Prices indicated on the Price Schedule shall be entered separately in the following manner:</p> <p style="padding-left: 40px;">a) For goods manufactured from within Pakistan (or within the country where procurement is being done in case of foreign missions abroad):</p> <p style="padding-left: 80px;">i. The price of the goods quoted EXW (ex-works, ex-factory, ex-warehouse, ex-showroom, or off-the-shelf, as applicable), including all customs duties and sales and other taxes already paid or payable:</p> <p style="padding-left: 120px;">A. on the components and raw material used in the manufacturing or assembly of goods quoted ex-works or ex-factory; OR</p> <p style="padding-left: 120px;">B. on the previously imported goods of foreign origin quoted ex-warehouse, ex-showroom, or off-the-shelf.</p> <p style="padding-left: 80px;">ii. All applicable taxes which will be payable on the goods if the contract is awarded.</p> <p style="padding-left: 80px;">iii. The price for inland transportation, insurance, and other local costs incidental to delivery of the goods to their final destination, if specified in the BDS.</p> <p style="padding-left: 80px;">iv. The price of other (incidental or allied) services, if any, listed in the BDS.</p> <p style="padding-left: 40px;">b) For goods offered from abroad:</p> <p style="padding-left: 80px;">i. The price of the goods shall be quoted CIF named port of destination, or CIP border point, or CIP named place of destination, in the Procuring Agency's country, as specified in the BDS. In quoting the price, the Bidder shall be free to use transportation through carriers registered in any eligible countries. Similarly, the Bidder may obtain insurance services from any eligible source country. Or</p> <p style="padding-left: 80px;">ii. The price of the goods quoted FOB port of shipment (or FCA, as the case may be), if specified in the BDS. Or</p> <p style="padding-left: 80px;">iii. The price of goods quoted CFR port of destination (or CPT as the case may be), if specified in the BDS.</p>
--	---



	<p>iv. the price for inland transportation, insurance, and other local costs incidental to delivery of the goods from the port of entry to their final destination, if specified in the BDS.</p> <p>v. The price of (incidental) services, if any, listed in the BDS.</p> <p>15.7 Prices proposed on the Price Schedule for goods and related services shall be disaggregated, where appropriate as indicated in this Clause. This desegregation shall be solely for the purpose of facilitating the comparison of Bids by the Procuring Agency. This, shall not in any way limit the Procuring Agency's right to contract on any of the terms and conditions offered: -</p> <p style="text-align: center;">a) For Goods: -</p> <p>i) the price of the Goods, quoted as per applicable INCOTERMS as specified in the BDS</p> <p>ii) all customs duties, sales tax, and other taxes applicable on goods or on the components and raw materials used in their manufacture or assembly, if the contract is awarded to the Bidder, and</p> <p style="text-align: center;">b) For Related Services</p> <p>i) The price of the related services, and</p> <p>ii) All customs duties, sales tax and other taxes applicable in Pakistan, paid or payable, on the related services, if the contract is awarded to the Bidder.</p> <p>15.8 Prices quoted by the Bidder shall be fixed during the Bidder's performance of the contract and not subject to variation on any account. A Bid submitted with an adjustable price will be treated as non-responsive and shall be rejected, pursuant to ITB 29.</p> <p>15.9 If so indicated in the Invitation to Bids and Instructions to Bidders, that Bids are being invited for individual contracts (Lots) or for any combination of contracts (packages), Bidders wishing to offer any price reduction for the award of more than one contract shall specify in their Bid the price reductions applicable to each package, or alternatively, to individual contracts (Lots) within a package.</p>
16. Bid Currencies	16.1 Prices shall be quoted in the following currencies:



	<p>a) For goods and services that the Bidder will deliver from within Pakistan, the prices shall be quoted in Pakistani Rupees, unless otherwise specified in the BDS.</p> <p>b) For goods and related services that the Bidder will deliver from outside Pakistan, or for imported parts or components of goods and related services originating outside Pakistan, the Bid prices shall be quoted in any freely convertible currency of another country. If the Bidder wishes to be paid in a combination of amounts in different currencies, it may quote its price accordingly but use no more than three foreign currencies.</p> <p>16.2 For the purposes of comparison of bids quoted in different currencies, the price shall be converted into a single currency specified in the bidding documents. The rate of exchange shall be the selling rate, prevailing on the date of opening of (financial part of) bids specified in the bidding documents, as notified by the State Bank of Pakistan on that day.</p> <p>16.3 Bidders shall indicate details of their expected foreign currency requirements in the Bid.</p> <p>16.4 Bidders may be required by the Procuring Agency to clarify their foreign currency requirements and to substantiate that the amounts included in Lump Sum and in the SCC are reasonable and responsive to ITB 16.1.</p>
<p>17. Bid Validity Period</p>	<p>17.1 Bids shall remain valid for the period specified in the BDS after the Bid submission deadline prescribed by the Procuring Agency. A Bid valid for a shorter period shall be rejected by the Procuring Agency as non-responsive. The period of Bid validity will be determined from the complementary bid securing instrument i.e., the expiry period of bid security or bid securing declaration as the case may be.</p> <p>17.2 Under exceptional circumstances, prior to the expiration of the initial Bid validity period, the Procuring Agency may request the Bidders' consent to an extension of the period of validity of their Bids only once, for the period not more than the period of initial bid validity. The request and the Bidders responses shall be made in writing or in electronic forms that provide record of the content of communication. The Bid Security provided under ITB 18 shall also be suitably extended. A Bidder may refuse the request without forfeiting its Bid security or causing to be executed its Bid Securing Declaration. A Bidder agreeing to the request will not be required nor permitted to modify its Bid, but will be required to extend the validity of its Bid Security or Bid Securing</p>



	<p>Declaration for the period of the extension, and in compliance with ITB 18 in all respects.</p> <p>17.3 If the award is delayed by a period exceeding sixty (60) days beyond the expiry of the initial Bid validity period, the contract price may be adjusted by a factor specified in the request for extension. However, the Bid evaluation shall be based on the already quoted Bid Price without taking into consideration on the above correction.</p>
<p>18. Bid Security or Bid Securing Declaration</p>	<p>18.1 Pursuant to ITB 11, unless otherwise specified in the BDS, the Bidder shall furnish as part of its Bid, a Bid Security in form of fixed amount not exceeding five percent of the estimated value of procurement determined by the procuring agency and in the amount and currency specified in the BDS or Bid Securing Declaration as specified in the BDS in the format provided in Section VI (Standard Forms).</p> <p>18.2 The Bid Security or Bid Securing Declaration is required to protect the Procuring Agency against the risk of Bidder's conduct which would warrant the security's forfeiture, pursuant to ITB 18.9.</p> <p>18.3 The Bid Security shall be denominated in the local currency or in another freely convertible currency, and it shall be in the form specified in the BDS which shall be in any of the following:</p> <ul style="list-style-type: none"> a) a bank guarantee, an irrevocable letter of credit issued by a Scheduled bank in the form provided in the Bidding Documents or another form acceptable to the Procuring Agency and valid for twenty-eight (28) days beyond the end of the validity of the Bid. This shall also apply if the period for Bid Validity is extended. In either case, the form must include the complete name of the Bidder; b) a cashier's or certified cheque; or c) another security if indicated in the BDS <p>18.4 The Bid Security or Bid Securing Declaration shall be in accordance with the Form of the Bid Security or Bid Securing Declaration included in Section VI (Standard Forms) or another form approved by the Procuring Agency prior to the Bid submission.</p>



	<p>18.5 The Bid Security shall be payable promptly upon written demand by the Procuring Agency in case any of the conditions listed in ITB 18.9 are invoked.</p> <p>18.6 Any Bid not accompanied by a Bid Security or Bid Securing Declaration in accordance with ITB 18.1 or 18.3 shall be rejected by the Procuring Agency as non-responsive, pursuant to ITB 29.</p> <p>18.7 Unsuccessful Bidders' Bid Security will be discharged or returned as promptly as possible, however in no case later than thirty (30) days after the expiration of the period of Bid Validity prescribed by the Procuring Agency pursuant to ITB 17. The Procuring Agency shall make no claim to the amount of the Bid Security, and shall promptly return the Bid Security document, after whichever of the following that occurs earliest:</p> <ul style="list-style-type: none"> (a) the expiry of the Bid Security; (b) the entry into force of a procurement contract and the provision of a performance security (or guarantee), for the performance of the contract if such a security (or guarantee), is required by the Bidding documents; (c) the rejection by the Procuring Agency of all Bids; (d) the withdrawal of the Bid prior to the deadline for the submission of Bids, unless the Bidding documents stipulate that no such withdrawal is permitted. <p>18.8 The successful Bidder's Bid Security will be discharged upon the Bidder signing the contract pursuant to ITB 42, or furnishing the performance guarantee, pursuant to ITB 43.</p> <p>18.9 The Bid Security may be forfeited or the Bid Securing Declaration executed:</p> <ul style="list-style-type: none"> a) if a Bidder: <ul style="list-style-type: none"> i) withdraws its Bid during the period of Bid Validity as specified by the Procuring Agency, and referred by the bidder on the Form of Bid except as provided for in ITB 17.2; or ii) does not accept the correction of errors pursuant to ITB 31.2; or b) in the case of a successful Bidder, if the Bidder fails: <ul style="list-style-type: none"> i) to sign the contract in accordance with ITB 42; or
--	--



	<p>ii) to furnish performance security (or guarantee) in accordance with ITB 43.</p>
<p>19. Alternative Bids by Bidders</p>	<p>19.1 Bidders shall submit offers that comply with the requirements of the Bidding Documents, including the basic Bidder's technical design as indicated in the specifications and Schedule of Requirements. Alternatives will not be considered, unless specifically allowed for in the BDS. If so allowed, ITB 19.2 shall prevail.</p> <p>19.2 When alternative schedule for supply and installation of equipment is explicitly invited, a statement of that effect will be included in the BDS as will the method for evaluating different schedule for delivery of goods.</p> <p>19.3 If so allowed in the BDS, Bidders wishing to offer technical alternatives to the requirements of the Bidding Documents must also submit a Bid that complies with the requirements of the Bidding Documents, including the basic technical design as indicated in the specifications. In addition to submitting the basic Bid, the Bidder shall provide all information necessary for a complete evaluation of the alternative by the Procuring Agency, including technical specifications, breakdown of prices, and other relevant details. Only the technical alternatives, if any, of the Most Advantageous Bidder conforming to the basic technical requirements (without altering the bid price) shall be considered by the Procuring Agency.</p>
<p>20. Withdrawal, Substitution, and Modification of Bids</p>	<p>20.1 Before bid submission deadline, any bidder may withdraw, substitute, or modify its Bid after it has been submitted by sending a written notice, duly signed by an authorized representative, and the corresponding substitution or modification must accompany the respective written notice.</p> <p>20.2 Bids requested to be withdrawn in accordance with ITB 20.1 shall be returned unopened to the Bidders.</p>
<p>21. Format and Signing of Bid</p>	<p>c) The Bidder shall prepare an original and the number of copies of the Bid as indicated in the BDS, clearly marking each "ORIGINAL" and "COPY," as appropriate. In the event of any discrepancy between them, the original shall prevail:</p> <p>Provided that except in Single Stage One Envelope Procedure, the Bid shall include only the copies of technical proposal.</p> <p>21.2 The original and the copy or copies of the Bid shall be typed or written in indelible ink and shall be signed by the Bidder or a person or persons duly authorized to sign on behalf of the Bidder. This authorization shall consist of a written confirmation as specified in the BDS and shall be attached to</p>



	<p>the Bid. The name and position held by each person signing the authorization must be typed or printed below the signature. All pages of the Bid, except for un-amended printed literature, shall be initialed by the person or persons signing the Bid.</p> <p>21.3 Any interlineations, erasures, or overwriting shall be valid only if they are signed by the person or persons signing the Bidder.</p>
<p><u>D. Submission of Bids</u></p>	
<p>22. Sealing and Marking of Bids</p>	<p>22.1 In case of Single Stage One Envelope Procedure, the Bidder shall seal the original and each copy of the Bid in separate envelopes, duly marking the envelopes as "ORIGINAL" and "COPY." The envelopes shall then be sealed in an outer envelope securely sealed in such a manner that opening and resealing cannot be achieved undetected.</p> <p>Note: <i>The envelopes shall be sealed and marked in accordance with the bidding procedure adopted as referred in Rule-36 of PPR-2004.</i></p> <p>22.2 The inner and outer envelopes shall:</p> <ol style="list-style-type: none"> a) be addressed to the Procuring Agency at the address given in the BDS; and b) bear the title of the subject procurement or Project name, as the case may be as indicated in the BDS, the Invitation to Bids (ITB) title and number indicated in the BDS, and a statement: "DO NOT OPEN BEFORE," to be completed with the time and the date specified in the BDS, pursuant to ITB 23.1. <p>22.3 In case of Single Stage Two Envelope Procedure, The Bid shall comprise two envelopes submitted simultaneously, one called the Technical Proposal and the other Financial Proposal. Both envelopes to be enclosed together in an outer single envelope called the Bid. Each Bidder shall submit his bid as under:</p> <ol style="list-style-type: none"> a) Bidder shall submit his TECHNICAL PROPOSAL and FINANCIAL PROPOSAL in separate inner envelopes and enclosed in a single outer envelope. b) ORIGINAL and each copy of the Bid shall be separately sealed and put in separate envelopes and marked as such. c) The envelopes containing the ORIGINAL and copies will be put in one sealed envelope and addressed / identified as given in Sub- Clause 21.2. <p>22.4 The inner and outer envelopes shall:</p>



	<p>a) be addressed to the Procuring Agency at the address provided in the Bidding Data;</p> <p>b) bear the name and identification number of the contract as defined in the Bidding Data; and provide a warning not to open before the time and date for bid opening, as specified in the Bidding Data. Pursuant to ITB 23.1.</p> <p>c) In addition to the identification required in Sub- Clause 21.2 hereof, the inner envelope shall indicate the name and address of the bidder to enable the bid to be returned unopened in case it is declared "late" pursuant to Clause IB.24</p> <p>If all envelopes are not sealed and marked as require by ITB 22.2, ITB 22.3 and ITB 22.4 or incorrectly marked, the Procuring Agency will assume no responsibility for the misplacement or premature opening of Bid</p>
<p>23. Deadline for Submission of Bids</p>	<p>23.1 Bids shall be received by the Procuring Agency no later than the date and time specified in the BDS.</p> <p>23.2 The Procuring Agency may, in exceptional circumstances and at its discretion, extend the deadline for the submission of Bids by amending the Bidding Documents in accordance with ITB 9, in which case all rights and obligations of the Procuring Agency and Bidders previously subject to the deadline will thereafter be subject to the new deadline.</p>
<p>24. Late Bids</p>	<p>24.1 The Procuring Agency shall not consider for evaluation any Bid that arrives after the deadline for submission of Bids, in accordance with ITB 23.</p> <p>24.2 Any Bid received by the Procuring Agency after the deadline for submission of Bids shall be declared late, recorded, rejected and returned unopened to the Bidder.</p>
<p>25. Withdrawal, of Bids</p>	<p>25.1 A Bidder may withdraw its Bid after it has been submitted, provided that written notice of the withdrawal of the Bid, is received by the Procuring Agency prior to the deadline for submission of Bids.</p> <p>25.2 Revised bid may be submitted after the withdrawal of the original bid in accordance with the provisions referred in ITB 22.</p>
<p><u>E. Opening and Evaluation of Bids</u></p>	
<p>26. Opening of Bids</p>	<p>26.1 The Procuring Agency will open all Bids, in public, in the presence of Bidders' or their representatives who choose to attend, and other parties with a legitimate interest in the Bid proceedings at the place, on the date and at the time, specified</p>



	<p>in the BDS. The Bidders' representatives present shall sign a register as proof of their attendance.</p> <p>26.2 First, envelopes marked "WITHDRAWAL" shall be opened and read out and the envelope with the corresponding bid shall not be opened, but returned to the Bidder. No bid withdrawal shall be permitted unless the corresponding Withdrawal Notice contains a valid authorization to request the withdrawal and is read out at bid opening.</p> <p>26.3 Second, outer envelopes marked "SUBSTITUTION" shall be opened. The inner envelopes containing the Substitution Bid shall be exchanged for the corresponding Original Bid being substituted, which is to be returned to the Bidder unopened. No envelope shall be substituted unless the corresponding Substitution Notice contains a valid authorization to request the substitution and is read out and recorded at bid opening.</p> <p>26.4 Next, outer envelopes marked "MODIFICATION" shall be opened. No Technical Proposal and/or Financial Proposal shall be modified unless the corresponding Modification Notice contains a valid authorization to request the modification and is read out and recorded at the opening of the Bids. Any Modification shall be read out along with the Original Bid except in case of Single Stage Two Envelope Procedure where only the Technical Proposal, both Original as well as Modification, are to be opened, read out, and recorded at the opening. Financial Proposal, both Original and Modification, will remain unopened till the prescribed financial bid opening date.</p> <p>26.5 Other envelopes holding the Bids shall be opened one at a time, in case of Single Stage One Envelope Procedure, the Bidders names, the Bid prices, the total amount of each Bid and of any alternative Bid (if alternatives have been requested or permitted), any discounts, the presence or absence of Bid Security, Bid Securing Declaration and such other details as the Procuring Agency may consider appropriate, will be announced by the Procurement Evaluation Committee.</p> <p>26.6 In case of Single Stage Two Envelope Procedure, the Procuring Agency will open the Technical Proposals in public at the address, date and time specified in the BDS in the presence of Bidders' designated representatives who choose to attend and other parties with a legitimate interest in the Bid proceedings. The Financial Proposals will remain unopened and will be held in custody of the Procuring Agency until the specified time of their opening.</p> <p>26.7 The envelopes holding the Technical Proposals shall be opened one at a time, and the following read out and</p>
--	--



	<p>recorded: (a) the name of the Bidder; (b) whether there is a modification or substitution; (c) the presence of a Bid Security, if required; and (d) Any other details as the Procuring Agency may consider appropriate.</p> <p>26.8 Bids not opened and not read out at the Bid opening shall not be considered further for evaluation, irrespective of the circumstances. In particular, any discount offered by a Bidder which is not read out at Bid opening shall not be considered further.</p> <p>26.9 Bidders are advised to send in a representative with the knowledge of the content of the Bid who shall verify the information read out from the submitted documents. Failure to send a representative or to point out any un-read information by the sent Bidder's representative shall indemnify the Procuring Agency against any claim or failure to read out the correct information contained in the Bidder's Bid.</p> <p>26.10 No Bid will be rejected at the time of Bid opening except for late Bids which will be returned unopened to the Bidder, pursuant to ITB 24.</p> <p>26.11 The Procuring Agency shall prepare minutes of the Bid opening. The record of the Bid opening shall include, as a minimum: the name of the Bidder and whether or not there is a withdrawal, substitution or modification, the Bid price if applicable, including any discounts and alternative offers and the presence or absence of a Bid Security or Bid Securing Declaration.</p> <p>26.12 The Bidders' representatives who are present shall be requested to sign on the attendance sheet. The omission of a Bidder's signature on the record shall not invalidate the contents and affect the record. A copy of the record shall be distributed to all the Bidders.</p> <p>26.13 A copy of the minutes of the Bid opening shall be furnished to individual Bidders upon request.</p> <p>26.14 In case of Single Stage Two Envelop Bidding Procedure, after the evaluation and approval of technical proposal the procuring agency, shall at a time within the bid validity period, publically open the financial proposals of the technically accepted bids only. The financial proposal of bids found technically non-responsive shall be returned unopened to the respective bidder's subject to redress of the grievances from all tiers of grievances.</p>
27. Confidentiality	27.1 Information relating to the examination, clarification, evaluation and comparison of Bids and recommendation of



	<p>contract award shall not be disclosed to Bidders or any other persons not officially concerned with such process until the time of the announcement of the respective evaluation report.</p> <p>27.2 Any effort by a Bidder to influence the Procuring Agency processing of Bids or award decisions may result in the rejection of its Bid.</p> <p>27.3 Notwithstanding ITB 27.2 from the time of Bid opening to the time of contract award, if any Bidder wishes to contact the Procuring Agency on any matter related to the Bidding process, it should do so in writing or in electronic forms that provides record of the content of communication.</p>
<p>28. Clarification of Bids</p>	<p>28.1 To assist in the examination, evaluation and comparison of Bids of the Bidders, the Procuring Agency may, ask any Bidder for a clarification. Any clarification submitted by a Bidder that is not in response to a request by the Procuring Agency shall not be considered.</p> <p>28.2 The request for clarification and the response shall be in writing or in electronic forms that provide record of the content of communication. In case of Single Stage Two Envelope Procedure, no change in the prices or substance of the Bid shall be sought, offered, or permitted, whereas in case of Single Stage One Envelope Procedure, only the correction of arithmetic errors discovered by the Procuring Agency in the evaluation of Bids should be sought in accordance with ITB 31.</p> <p>28.3 The alteration or modification in THE BID which in any affect the following parameters will be considered as a change in the substance of a bid:</p> <ul style="list-style-type: none"> a. evaluation & qualification criteria; b. required scope of work or specifications; c. all securities requirements; d. tax requirements; e. terms and conditions of bidding documents. f. change in the ranking of the bidder <p>28.4 From the time of Bid opening to the time of Contract award if any Bidder wishes to contact the Procuring Agency on any matter related to the Bid it should do so in writing or in electronic forms that provide record of the content of communication.</p>
<p>29. Preliminary Examination of Bids</p>	<p>29.1 Prior to the detailed evaluation of Bids, the Procuring Agency will determine whether each Bid:</p>



	<p>a. meets the eligibility criteria defined in ITB 3 and ITB 4;</p> <p>b. has been prepared as per the format and contents defined by the Procuring Agency in the Bidding Documents;</p> <p>c. has been properly signed;</p> <p>d. is accompanied by the required securities; and</p> <p>e. is substantially responsive to the requirements of the Bidding Documents.</p> <p>The Procuring Agency's determination of a Bid's responsiveness will be based on the contents of the Bid itself.</p> <p>29.2 A substantially responsive Bid is one which conforms to all the terms, conditions, and specifications of the Bidding Documents, without material deviation or reservation. A material deviation or reservation is one that: -</p> <p>a. affects in any substantial way the scope, quality, or performance of the Services;</p> <p>b. limits in any substantial way, inconsistent with the Bidding Documents, the Procuring Agency's rights or the Bidders obligations under the Contract; or</p> <p>c. if rectified, would affect unfairly the competitive position of other Bidders presenting substantially responsive Bids.</p> <p>29.3 The Procuring Agency will confirm that the documents and information specified under ITB 11, 12 and 13 have been provided in the Bid. If any of these documents or information is missing, or is not provided in accordance with the Instructions to Bidders, the Bid shall be rejected.</p> <p>29.4 The Procuring Agency may waive off any minor informality, nonconformity, or irregularity in a Bid which does not constitute a material deviation, provided such waiver does not prejudice or affect the relative ranking of any Bidder.</p> <p>Explanation: <i>A minor informality, non-conformity or irregularity is one that is merely a matter of form and not of substance. It also pertains to some immaterial defect in a Bid or variation of a bid from the exact requirements of the invitation that can be corrected or waived without being prejudicial to other bidders. The defect or variation is immaterial when the effect on quantity, quality, or delivery is negligible when contrasted with the total cost or scope of the supplies or services being acquired. The Procuring Agency either shall give the bidder an opportunity to cure any</i></p>
--	--



	<p><i>deficiency resulting from a minor informality or irregularity in a bid or waive the deficiency, whichever is advantageous to the Procuring Agency. Examples of minor informalities or irregularities include failure of a bidder to –</i></p> <p>(a) <i>Submit the number of copies of signed bids required by the invitation;</i></p> <p>(b) <i>Furnish required information concerning the number of its employees;</i></p> <p>(c) <i>The firm submitting a bid has formally adopted or authorized, before the date set for opening of bids, the execution of documents by typewritten, printed, or stamped signature and submits evidence of such authorization and the bid carries such a signature.</i></p> <p>29.5 Provided that a Technical Bid is substantially responsive, the Procuring Agency may request the Bidder to submit the necessary information or documentation, within a reasonable period of time, to rectify nonmaterial nonconformities or omissions in the Technical Bid related to documentation requirements. Requesting information or documentation on such nonconformities shall not be related to any such aspect of the technical Proposal linked with the ranking of the bidders. Failure of the Bidder to comply with the request may result in the rejection of its Bid.</p> <p>29.6 Provided that a Technical Bid is substantially responsive, the Procuring Agency shall rectify quantifiable nonmaterial nonconformities or omissions related to the Financial Proposal. To this effect, the Bid Price shall be adjusted, for comparison purposes only, to reflect the price of the missing or nonconforming item or component.</p> <p>29.7 If a Bid is not substantially responsive, it will be rejected by the Procuring Agency and may not subsequently be evaluated for complete technical responsiveness.</p>
<p>30. Examination of Terms and Conditions; Technical Evaluation</p>	<p>30.1 The Procuring Agency shall examine the Bid to confirm that all terms and conditions specified in the GCC and the SCC have been accepted by the Bidder without any material deviation or reservation.</p> <p>30.2 The Procuring Agency shall evaluate the technical aspects of the Bid submitted in accordance with ITB 22, to confirm that all requirements specified in Section V – Schedule of Requirements, Technical Specifications of the Bidding Documents have been met without material deviation or reservation.</p>



	30.3	If after the examination of the terms and conditions and the technical evaluation, the Procuring Agency determines that the Bid is not substantially responsive in accordance with ITB 29 , it shall reject the Bid.
31. Correctness of Errors	31.1	<p>Bids determined to be substantially responsive will be checked for any arithmetic errors. Errors will be corrected as follows: -</p> <ol style="list-style-type: none"> a. if there is a discrepancy between unit prices and the total price that is obtained by multiplying the unit price and quantity, the unit price shall prevail, and the total price shall be corrected, unless in the opinion of the Procuring Agency there is an obvious misplacement of the decimal point in the unit price, in which the total price as quoted shall govern and the unit price shall be corrected; b. if there is an error in a total corresponding to the addition or subtraction of sub-totals, the sub-totals shall prevail and the total shall be corrected; and c. where there is a discrepancy between the amounts in figures and in words, the amount in words will govern. d. Where there is discrepancy between grand total of price schedule and amount mentioned on the Form of Bid, the amount referred in Price Schedule shall be treated as correct subject to elimination of other errors.
	31.2	The amount stated in the Bid will, be adjusted by the Procuring Agency in accordance with the above procedure for the correction of errors and, with, the concurrence of the Bidder, shall be considered as binding upon the Bidder. If the Bidder does not accept the corrected amount, its Bid will then be rejected, and the Bid Security may be forfeited or the Bid Securing Declaration may be executed in accordance with ITB 18.9 .
32. Conversion to Single Currency	32.1	To facilitate evaluation and comparison, the Procuring Agency will convert all Bid prices expressed in the amounts in various currencies in which the Bid prices are payable. For the purposes of comparison of bids quoted in different currencies, the price shall be converted into a single currency specified in the bidding documents. The rate of exchange shall be the selling rate, prevailing on the date of opening of (financial part of) bids specified in the bidding documents, as notified by the State Bank of Pakistan on that day.



	<p>32.2 The currency selected for converting Bid prices to a common base for the purpose of evaluation, along with the source and date of the exchange rate, are specified in the BDS.</p>
<p>33. Evaluation of Bids</p>	<p>33.1 The Procuring Agency shall evaluate and compare only the Bids determined to be substantially responsive, pursuant to ITB 29.</p> <p>33.2 In evaluating the Technical Proposal of each Bid, the Procuring Agency shall use the criteria and methodologies listed in the BDS and in terms of Statement of Requirements and Technical Specifications. No other evaluation criteria or methodologies shall be permitted.</p> <p>33.3 The Procuring Agency's evaluation of a Bid will take into account:</p> <ul style="list-style-type: none"> a. in the case of goods manufactured in Pakistan or goods of foreign origin already imported in Pakistan, Income Tax, General Sales Tax and other similar/applicable taxes, which will be payable on the goods if a contract is awarded to the Bidder; b. in the case of goods of foreign origin offered from abroad, customs duties and other similar import taxes which will be payable on the goods if the contract is awarded to the Bidder; and <p>33.4 The comparison shall be between the EXW price of the goods offered from within Pakistan, such price to include all costs, as well as duties and taxes paid or payable on components and raw material incorporated or to be incorporated in the goods, and named port of destination, border point, or named place of destination) in accordance with applicable INCOTERM in the price of the goods offered from outside Pakistan.</p> <p>In evaluating the Bidders, the evaluation committee will, in addition to the Bid price quoted in accordance with ITB 15.1, take account of one or more of the following factors as specified in the BDS, and quantified in ITB 32.5:</p> <ul style="list-style-type: none"> a. Cost of inland transportation, insurance, and other costs within the Pakistan incidental to delivery of the goods to their final destination. b. delivery schedule offered in the Bid; c. deviations in payment schedule from that specified in the Special Conditions of Contract; d. the cost of components, mandatory spare parts, and service;



	<p>e. the availability (in Pakistan) of spare parts and after-sales services for the equipment offered in the Bid;</p> <p>f. the projected operating and maintenance costs during the life of the equipment;</p> <p>g. the performance and productivity of the equipment offered; and/or;</p> <p>h. other specific criteria indicated in the TBS and/or in the Technical Specifications.</p> <p>33.5 For factors retained in BDS, pursuant to ITB 33.4 one or more of the following quantification methods will be applied, as detailed in the BDS:</p> <p>a. <i>Inland transportation from EXW/port of entry/border point, Insurance and incidentals:</i> Inland transportation, insurance, and other incidental costs for delivery of the goods from EXW/port of entry/border point to Project Site named in the BDS will be computed for each Bid by the PA on the basis of published tariffs by the rail or road transport agencies, insurance companies, and/or other appropriate sources. To facilitate such computation, Bidder shall furnish in its Bid the estimated dimensions and shipping weight and the approximate EXW or as per applicable INCOTERM value of each package. The above cost will be added by the Procuring Agency to EXW or as per applicable INCOTERM price.</p> <p>b. <i>Delivery Schedule</i></p> <p>i) The Procuring Agency requires that the goods under the Invitation for Bids shall be delivered (shipped) at the time specified in the Schedule of Requirements. The estimated time of arrival of the goods at the Project Site will be calculated for each Bid after allowing for reasonable international and inland transportation time. Treating the Bid resulting in such time of arrival as the base, a delivery "adjustment" will be calculated for other Bids by applying a percentage, specified in the BDS, of the EXW or as per applicable INCOTERM price for each week of delay beyond the base, and this will be added to the Bid price for evaluation. No credit shall be given to early delivery. OR</p> <p>ii) The goods covered under this invitation are</p>
--	--



	<p>required to be delivered (shipped) within an acceptable range of weeks specified in the Schedule of Requirement. No credit will be given to earlier deliveries, and Bids offering delivery beyond this range will be treated as non-responsive. Within this acceptable range, an adjustment per week, as specified in the BDS, will be added for evaluation to the Bid price of Bids offering deliveries later than the earliest delivery period specified in the Schedule of Requirements. OR</p> <p>iii) The goods covered under this invitation are required to be delivered (shipped) in partial shipments, as specified in the Schedule of Requirements. Bids offering deliveries earlier or later than the specified deliveries will be adjusted in the evaluation by adding to the Bid price a factor equal to a percentage, specified in the BDS, of EXW or as per applicable INCOTERM price per week of variation from the specified delivery schedule.</p> <p>c. <i>Deviation in Payment Schedule</i></p> <p>i) Bidders shall state their Bid price for the payment schedule outlined in the SCC. Bids will be evaluated on the basis of this base price. Bidders are, however, permitted to state an alternative payment schedule and indicate the reduction in Bid price they wish to offer for such alternative payment schedule. The Procuring Agency may consider the alternative payment schedule offered by the selected Bidder. OR</p> <p>ii) The SCC stipulates the payment schedule offered by the Procuring Agency. If a Bid deviates from the schedule and if such deviation is considered acceptable to the Procuring Agency, the Bid will be evaluated by calculating interest earned for any earlier payments involved in the terms outlined in the Bid as compared with those stipulated in this invitation, at the rate per annum specified in the BDS.</p>
--	---



d. Cost of Spare Parts

- i) The list of items and quantities of major assemblies, components, and selected spare parts, likely to be required during the initial period of operation specified in the **BDS**, is annexed to the Technical Specifications. The total cost of these items, at the unit prices quoted in each Bid, will be added to the Bid price. **OR**
- ii) The Procuring Agency will draw up a list of high-usage and high-value items of components and spare parts, along with estimated quantities of usage in the initial period of operation specified in the **BDS**. The total cost of these items and quantities will be computed from spare parts unit prices submitted by the Bidder and added to the Bid price. **OR**
- iii) The Procuring Agency will estimate the cost of spare parts usage in the initial period of operation specified in the **BDS**, based on information furnished by each Bidder, as well as on past experience of the Procuring Agency or other Procuring Agency's in similar situations. Such costs shall be added to the Bid price for evaluation

e. Spare parts and after sales service facilities in Pakistan

The cost to the Procuring Agency of establishing the minimum service facilities and parts inventories, as outlined in the **BDS** or elsewhere in the Bidding Documents, if quoted separately, shall be added to the Bid price.

f. Operating and maintenance costs

Since the operating and maintenance costs of the goods under procurement form a major part of the life cycle cost of the equipment, these costs will be evaluated in accordance with the criteria specified in the **BDS** or in the Technical Specifications.

g. Performance and productivity of the equipment.

- (i) Bidders shall state the guaranteed performance



	<p>or efficiency in response to the Technical Specification. For each drop in the performance or efficiency below the norm of 100, an adjustment for an amount specified in the BDS will be added to the Bid Price, representing the capitalized cost of additional operating costs over the life of the plant, using the methodology specified in the BDS or in the Technical Specifications. OR</p> <p>(ii) Goods offered shall have a minimum productivity specified under the relevant provision in the Technical Specifications to be considered responsive. Evaluation shall be based on the cost per unit of the actual productivity of goods offered in the Bid, and adjustment will be added to the Bid price using the methodology specified in the BDS or in the Technical Specifications.</p> <p>h. <i>Specific Additional Criteria</i></p> <p>Other specific additional criteria to be considered in the evaluation and the evaluation method shall be detailed in the BDS and/or the Technical Specifications.</p> <p>33.6 If these Bidding Documents allow Bidders to quote separate prices for different Lots, and the award to a single Bidder of multiple Lots, the methodology of evaluation to determine the lowest evaluated Lot combinations, including any discounts offered in the Form of Bid, is specified in the BDS.</p>
<p>34. Domestic Preferences</p>	<p>34.1 If the BDS so specifies, the Procuring Agency will grant a margin of preference to certain goods in line with the rules, regulations, regulatory guides or instructions issued by the Authority from time to time.</p>
<p>35. Determination of Most Advantageous Bid</p>	<p>35.1 In case where the Procuring Agency adopts the Cost Based Evaluation Technique and, the Bid with the lowest evaluated price—from amongst those which are eligible, compliant and substantially responsive shall be the Most Advantageous Bid.</p> <p>35.2 The Procuring Agency may adopt the Quality & Cost Based Selection Technique due to the following two reasons:</p>



	<p>i. Where the Procuring Agency knows about the main features, usage and output of the products; however not clear about the complete features, technical specifications and functionalities of the goods to be procured and requires the bidders to submit their proposals defining those features, specifications and functionalities; or</p> <p>ii. Where the Procuring Agency, in addition to the mandatory requirements and mandatory technical specifications, requires parameters specified in Evaluation Criteria to be evaluated while determining the quality of the goods:</p> <p>In such cases, the Procuring Agency may allocate certain weightage to these factors as a part of Evaluation Criteria, and may determine the ranking of the bidders on the basis of combined evaluation in accordance with provisions of Rule 2(1)(h) of PPR-2004.</p>
<p>36. Post qualification of Bidder and/or Abnormally Low Financial Proposal</p>	<p>36.1 After determining the Most Advantageous Bid, if neither the pre-qualification was undertaken separately nor any qualification parameters were undertaken as part of determining the Most Advantageous Bid, the Procuring Agency shall carry out the post-qualification of the Bidder using only the requirements specified in the BDS. In case of International Tendering, the parameters for incorporation or licensing within Pakistan may be fulfilled as part of post qualification.</p> <p>36.2 Where the Bid price is considered to be abnormally low, the Procuring Agency shall perform price analysis either during determination of Most Advantageous Bid or as a part of the post-qualification process. The following process shall apply:</p> <p>(a) The Procuring Agency may reject a Bid if the Procuring Agency has determined that the price in combination with other constituent elements of the Bid is abnormally low in relation to the subject matter of the procurement (i.e. scope of the procurement or ancillary services) and raises concerns as to the capability and capacity of the respective Bidder to perform that contract</p>



- (b) Before rejecting an abnormally low Bid the Procuring Agency shall request the Bidder an explanation of the Bid or of those parts which it considers contribute to the Bid being abnormally low; take account of the evidence provided in response to a request in writing; and subsequently verify the Bid or parts of the Bid being abnormally low;
- (c) The decision of the Procuring Agency to reject a Bid and reasons for the decision shall be recorded in the procurement proceedings and promptly communicated to the Bidder concerned;
- (d) The Procuring Agency shall not incur any liability solely by rejecting abnormally Bid; and
- (e) An abnormally low Bid means, in the light of the Procuring Agency's estimate and of all the Bids submitted, the Bid appears to be abnormally low by not providing a margin for normal levels of profit.

Guidance for Procuring Agency:

In order to identify the Abnormally Low Bid (ALB) following approaches can be considered to minimize the scope of subjectivity:

- (i) Comparing the bid price with the cost estimate;
- (ii) Comparing the bid price with the bids offered by other bidders submitting substantially responsive bids; and
- (iii) Comparing the bid price with prices paid in similar contracts in the recent past either government- or development partner-funded.

36.3 The Procuring Agency will determine to its satisfaction whether the Bidder that is selected as having submitted the most advantageous Bid is qualified to perform the contract satisfactorily, in accordance with the criteria listed in ITB 13.3.

36.4 The determination will take into account the Bidder's financial, technical, and production capabilities. It will be based upon an examination of the documentary evidence of the Bidder's qualifications submitted by the Bidder, pursuant to ITB 13.3, as well as such other information as the Procuring Agency deems necessary and appropriate. Factors not included in these Bidding Documents shall not be used in the evaluation of the Bidders' qualifications.



	<p>36.5 Procuring Agency may seek “Certificate for Independent Price Determination” from the Bidder and the results of reference checks may be used in determining award of contract.</p> <p>Explanation: The Certificate shall be furnished by the bidder. The bidder shall certify that the price is determined keeping in view of all the essential aspects such as raw material, its processing, value addition, optimization of resources due to economy of scale, transportation, insurance and margin of profit etc.</p> <p>36.6 An affirmative determination will be a prerequisite for award of the contract to the Bidder. A negative determination will result in rejection of the Bidder’s Bid, in which event the Procuring Agency will proceed to the next ranked bidder to make a similar determination of that Bidder’s capabilities to perform satisfactorily.</p>
<p><u>F. Award of Contract</u></p>	
<p>37. Criteria of Award</p>	<p>37.1 Subject to ITB 36 and 38, the Procuring Agency will award the Contract to the Bidder whose Bid has been determined to be substantially responsive to the Bidding Documents and who has been declared as Most Advantageous Bidder, provided that such Bidder has been determined to be:</p> <ul style="list-style-type: none"> a) eligible in accordance with the provisions of ITB 3; b) is determined to be qualified to perform the Contract satisfactorily; and c) Successful negotiations have been concluded, if any.
<p>38. Negotiations</p>	<p>38.1 Negotiations may be undertaken with the Most Advantageous Bid relating to the following areas:</p> <ul style="list-style-type: none"> (a) a minor alteration to the technical details of the statement of requirements; (b) reduction of quantities for budgetary reasons, where the reduction is in excess of any provided for in the Bidding documents; (c) a minor amendment to the special conditions of Contract; (d) finalizing payment arrangements; (e) delivery arrangements; (f) the methodology for provision of related services; or (g) clarifying details that were not apparent or could not be finalized at the time of Bidding;



	<p>38.2 Where negotiation fails to result into an agreement, the Procuring Agency may invite the next ranked Bidder for negotiations. Where negotiations are commenced with the next ranked Bidder, the Procuring Agency shall not reopen earlier negotiations.</p>
<p>39. Procuring Agency's Right to reject All Bids</p>	<p>39.1 Notwithstanding ITB 37, the Procuring Agency reserves the right to reject all the bids, and to annul the Bidding process at any time prior to award of contract, without thereby incurring any liability to the affected Bidder or Bidders. However, the Authority (i.e. PPRA) may call from the Procuring Agency the justification of those grounds.</p> <p>39.2 Notice of the rejection of all Bids shall be given promptly to all Bidders that have submitted Bids.</p> <p>39.3 The Procuring Agency shall upon request communicate to any Bidder the grounds for its rejection of its Bids, but is not required to justify those grounds</p>
<p>40. Procuring Agency's Right to Vary Quantities at the time of Award</p>	<p>40.1 The Procuring Agency reserves the right at the time of contract award to increase or decrease the quantity of goods or related services originally specified in these Bidding Documents (schedule of requirements) provided this does not exceed by the percentage indicated in the BDS, without any change in unit price or other terms and conditions of the Bid and Bidding Documents.</p>
<p>41. Notification of Award</p>	<p>41.1 Prior to the award of contract, the Procuring Agency shall issue a Final Evaluation Report giving justification for acceptance or rejection of the bids.</p> <p>41.2 Where no complaints have been lodged, the Bidder whose Bid has been accepted will be notified of the award by the Procuring Agency prior to expiration of the Bid Validity period in writing or electronic forms that provide record of the content of communication. The Letter of Acceptance will state the sum that the Procuring Agency will pay the successful Bidder in consideration for the execution of the scope of works as prescribed by the Contract (hereinafter and in the Contract called the "Contract Price).</p> <p>41.3 The notification of award will constitute the formation of the Contract, subject to the Bidder furnishing the Performance Security (or guarantee) in accordance with ITB 43 and signing of the contract in accordance with ITB 42.2.</p> <p>41.4 Upon the successful Bidder's furnishing of the performance security (or guarantee) pursuant to ITB 43, the Procuring Agency will promptly notify each</p>



	<p>unsuccessful Bidder, the name of the successful Bidder and the Contract amount and will discharge the Bid Security or Bid Securing Declaration of the Bidders pursuant to ITB 18.7.</p>
42. Signing of Contract	<p>42.1 Promptly after notification of award, Procuring Agency shall send the successful Bidder the draft agreement, incorporating all terms and conditions as agreed by the parties to the contract.</p> <p>42.2 Immediately after the Redressal of grievance by the GRC, and after fulfillment of all conditions precedent of the Contract Form, the successful Bidder and the Procuring Agency shall sign the contract.</p> <p>42.3 Where no formal signing of a contract is required, purchase order issued to the bidder shall be construed to be the contract.</p>
43. Performance Security (or Guarantee)	<p>43.1 After the receipt of the Letter of Acceptance, the successful Bidder, within the specified time, shall deliver to the Procuring Agency a Performance Security (or Guarantee) in the amount and in the form stipulated in the BDS and SCC, denominated in the type and proportions of currencies in the Letter of Acceptance and in accordance with the Conditions of Contract.</p> <p>43.2 If the Performance Security (or Guarantee) is provided by the successful Bidder and it shall be in the form specified in the BDS which shall be in any of the following:</p> <ul style="list-style-type: none"> (a) certified cheque, cashier's or manager's cheque, or bank draft; (b) irrevocable letter of credit issued by a Scheduled bank or in the case of an irrevocable letter of credit issued by a foreign bank, the letter shall be confirmed or authenticated by a Scheduled bank. (c) bank guarantee confirmed by a reputable local bank or, in the case of a successful foreign Bidder, bonded by a foreign bank; or (d) surety bond callable upon demand issued by any reputable surety or insurance company. <p>Any Performance Security (or guarantee) submitted shall be enforceable in Pakistan.</p> <p>43.3 Failure of the successful Bidder to comply with the</p>



	requirement of ITB 43.1 shall constitute sufficient grounds for the annulment of the award and forfeiture of the Bid Security, in which event the Procuring Agency may make the award to the next ranked Bidder or call for new Bids.
44. Advance Payment	<p>44.1 The advance payment will not be provided in normal circumstances. However, in case where international incoterms are involved, the same will be dealt with standard international practices and in the manner as prescribed in ITB 44.2.</p> <p>44.2 The Procuring Agency will provide an Advance Payment as stipulated in the Conditions of Contract, subject to a maximum amount, as stated in the BDS. The Advance Payment request shall be accompanied by an Advance Payment Security (Guarantee) in the form provided in Section IX. For the purpose of receiving the Advance Payment, the Bidder shall make and estimate of, and include in its Bid, the expenses that will be incurred in order to commence Delivery of Goods. These expenses will relate to the purchase of equipment, machinery, materials, and on the engagement of labor during the first month beginning with the date of the Procuring Agency's "Notice to Commence" as specified in the SCC.</p>
45. Arbitrator	45.1 The Arbitrator shall be appointed by mutual consent of both parties as per the provisions specified in the SCC .
46. Corrupt and Fraudulent Practices	46.1 Procuring Agencies (including beneficiaries of Government funded projects and procurement) as well as Bidders/Suppliers/Contractors under Government financed contracts, observe the highest standard of ethics during the procurement and execution of such contracts, and will avoid to engage in any corrupt and fraudulent practices.
<u>G. Grievance Redressal & Complaint Review Mechanism</u>	
47. Constitution of Grievance Redressal Committee	47.1 Procuring agency shall constitute a Grievance Redressal Committee (GRC) comprising of odd number of person with proper power and authorization to address the complaint. The GRC shall not have any of the members of Procurement Evaluation Committee. The committee must have one subject specialist depending the nature of the procurement.
48. GRC Procedure	48.1 Any party can file its written complaint against the eligibility parameters or any other terms and conditions prescribed in the prequalification or bidding documents found contrary



	<p>to provision of Procurement Regulatory Framework, and the same shall be addressed by the GRC well before the bid submission deadline.</p> <p>48.2 Any Bidder feeling aggrieved by any act of the procuring agency after the submission of his bid may lodge a written complaint concerning his grievances not later than seven days of the announcement of technical evaluation report and five days after issuance of final evaluation report.</p> <p>48.3 In case, the complaint is filed against the technical evaluation report, the GRC shall suspend the procurement proceedings.</p> <p>48.4 In case, the complaint is filed after the issuance of the final evaluation report, the complainant cannot raise any objection on technical evaluation of the report: Provided that the complainant may raise the objection on any part of the final evaluation report in case where single stage one envelop bidding procedure is adopted.</p> <p>48.5 The GRC, in both the cases shall investigate and decide upon the complaint within ten days of its receipt.</p> <p>48.6 Any bidder or the procuring agency not satisfied with the decision of the GRC may file Appeal before the Appellate Committee of the Authority on prescribed format after depositing the prescribed fee.</p> <p>48.7 The Committee, upon receipt of the Appeal against the decision of the GRC complete in all respect shall serve notices in writing upon all the parties to Appeal.</p> <p>48.8 The committee shall call the record from the concerned procuring agency or the GRC as the case may be, and the same shall be provided within prescribed time.</p> <p>48.9 The committee may after examination of the relevant record and hearing all the concerned parties, shall decide the complaint within fifteen (15) days of receipt of the Appeal.</p> <p>48.10 The decision of the Committee shall be in writing and shall be signed by the Head and each Member of the Committee. The decision of the committee shall be final.</p>
<u>H. MECHANISM OF BLACKLISTING</u>	
<p>49. Mechanism of Blacklisting</p>	<p>49.1 The Procuring Agency shall bar for not more than the time prescribed in Rule-19 of the Public Procurement Rules, 2004, from participating in their respective procurement proceedings, bidder or contractor who either:</p> <ol style="list-style-type: none"> i. Involved in corrupt and fraudulent practices



	<p>as defined in Rule-2 of Public Procurement Rules;</p> <ul style="list-style-type: none"> ii. Fails to perform his contractual obligations; and iii. Fails to abide by the id securing declaration; <p>49.2 The show cause notice shall contain: (a) precise allegation, against the bidder or contractor; (b) the maximum period for which the Procuring Agency proposes to debar the bidder or contractor from participating in any public procurement of the Procuring Agency; and (c) the statement, if needed, about the intention of the Procuring Agency to make a request to the Authority for debarring the bidder or contractor from participating in public procurements of all the procuring agencies.</p> <p>49.3 The procuring agency shall give minimum of seven days to the bidder or contractor for submission of written reply of the show cause notice.</p> <p>49.4 In case, the bidder or contractor fails to submit written reply within the requisite time, the Procuring Agency may issue notice for personal hearing to the bidder or contractor/ authorize representative of the bidder or contractor and the procuring agency shall decide the matter on the basis of available record and personal hearing, if availed.</p> <p>49.5 In case the bidder or contractor submits written reply of the show cause notice, the Procuring Agency may decide to file the matter or direct issuance of a notice to the bidder or contractor for personal hearing.</p> <p>49.6 The Procuring Agency shall give minimum of seven days to the bidder or contractor for appearance before the specified officer of the Procuring Agency for personal hearing. The specified officer shall decide the matter on the basis of the available record and personal hearing of the bidder or contractor, if availed.</p> <p>49.7 The procuring Agency shall decide the matter within fifteen days from the date of personal hearing unless the personal hearing is adjourned to a next date and in such an eventuality, the period of personal hearing shall be reckoned from the last date of personal hearing.</p> <p>49.8 The Procuring Agency shall communicate to the bidder or contractor the order of debarring the bidder or contractor from participating in any public procurement with a</p>
--	---



	<p>statement that the bidder or contractor may, within thirty days, prefer a representation against the order before the Authority.</p> <p>49.9 Such blacklisting or barring action shall be communicated by the procuring agency to the Authority and respective bidder or bidders in the form of decision containing the grounds for such action. The same shall be publicized by the Authority after examining the record whether the procedure defined in blacklisting and debarment mechanism has been adhered to by the procuring agency.</p> <p>49.10 The bidder may file the review petition before the Review Petition Committee Authority within thirty days of communication of such blacklisting or barring action after depositing the prescribed fee and in accordance with "Procedure of filing and disposal of review petition under Rule-19(3) Regulations, 2021". The Committee shall evaluate the case and decide within ninety days of filing of review petition</p> <p>49.11 The committee shall serve a notice in writing upon all respondent of the review petition. The notices shall be accompanied by the copies of review petition and all attached documents of the review petition including the decision of the procuring agency. The parties may file written statements along with essential documents in support of their contentions. The Committee may pass such order on the representation may deem fit.</p> <p>49.12 The Authority on the basis of decision made by the committee either may debar a bidder or contractor from participating in any public procurement process of all or some of the procuring agencies for such period as the deemed appropriate or acquit the bidder from the allegations. The decision of the Authority shall be final.</p>
--	--



SECTION III: BID DATA SHEET



Section III. Bid Data Sheet (BDS)

BDS Clause Number	ITB Number	Amendments of, and Supplements to, Clauses in the Instruction to Bidders
1. INTRODUCTION		
1.	1.1	<p>Name of Procuring Agency: Pakistan Security Printing Corporation (Pvt.) Ltd.</p> <p>The Description (as specified in Invitation to e-Bids) of the Goods is: (1) Rechargeable Battery 6V (2) Dry Charged Battery 12V - 200N 200 AH (As per BOQ/Specifications) Delivery Schedule: Within 30 days from the date of contract award.</p>
2.	2.1	<p>Financial year for the operations of the Procuring Agency: [2025-26]</p> <p>Name of Project: (1) Rechargeable Battery 6V (2) Dry Charged Battery 12V - 200N 200 AH (As per BOQ/Specifications)</p> <p>Name and identification number of the Contract: Tender # LP/T-2406/26/NB</p>
3.	3.1	Joint Venture is Not Applicable
4.	4.1	Ineligible country(s) are [as per Section IV of the Bidding Documents]
5.	4.5	Demonstration of authorization by manufacturer: Manufacturer's Authorization Form is not required.
2. BIDDING DOCUMENTS		
6.	7.2	The number of documents to be completed and returned is one original using epads(uploading method). Each page duly signed and stamped.
7.	8.1	Clarification can be obtained through EPADS or email at purchase.local@pspc.gov.pk



	8.5	<p>A pre-bid meeting may be held before the date set for opening of Bid. In case if the Procuring Agency decides to hold the pre-bid meeting, then the information of the date, time and venue of the meeting will be communicated to the Bidders. The Bidders shall send in writing to the Procuring Agency any clarifications, enquiries he considers necessary in respect of the provisions of the Bidding Documents before the date of pre-bid meeting. Any cost to be incurred to attend the pre-bid meeting will be borne by the Bidder(s).</p> <p>Not Applicable</p>
3. PREPARATION OF BIDS		
1.	10.1	The Language of all correspondences and documents related to the Bid is English .
2.	11.1 (h)	<p>In addition to the documents stated in ITB 11, the following documents must be included with the Bid</p> <p>a) Affidavit for Bidder's Blacklisting Status b) Declaration for Beneficial Ownership</p>
3.	12.3 I	Other procurement specific documentation requirements are Not Required
4.	12.4	The Bidder shall be required to provide an undertaking that they will ensure to supply spare parts as per BOQ / Technical Specification and perform installation & commissioning as per technical specification. In case of up gradation or modification in software or spare parts.
5.	13.3 (b)	<p>The eligibility and qualification criteria required from Bidders in ITB 13.3(b) is modified as follows:</p> <p>d) <i>This invitation for Bids is open to all reputed manufacturer / contractors / suppliers.</i></p> <p>e) <i>Bidders should not be under a declaration of ineligibility for corrupt and fraudulent practices issued by any Government (Federal, Provincial), a local body and international or a public sector organization.</i></p> <p>f) <i>They must be registered with tax authorities and are active tax payers.</i></p> <p>g) <i>The bidder must meet all the terms and conditions given in Technical Specifications and BOQ of this Tender Document.</i></p> <p>h) <i>The bidder and their deputed staff must submit an undertaking to comply with PSPC's Code of Conduct, using the prescribed format provided in the tender document.</i></p>



		<p>i) The bidder must submit an undertaking to comply with all applicable HSE laws, regulations and industry standards; and with all HSE requirements of PSPC, using the prescribed format provided in the tender document.</p> <p>j) Where an experience certificate is required under any tender, the same must be issued strictly in the name of the bidder. Experience certificates issued in the name of any other individual, firm, affiliate, joint venture partner, or obtained through sub-letting, subcontracting, or any similar arrangement shall not be acceptable.</p> <p>k) Any regular employee, contractual, or outsourced/third-party resource who are currently or were previously deputed on PSPC assignments during last 5 years are not authorized to participate in the bidding process for next 3 years either as a bidder or as a representative of any bidder/vendor. PSPC reserves the right to reject such bids at any stage of the procurement process.</p>
6.	15.7 (a) (i)	<p>For goods manufactured or delivered from within Pakistan the price quoted shall be on a Delivered Duty Paid (DDP) basis, inclusive of all taxes, stamps, duties, levies, fees, transportation, insurance, incidental services imposed till the delivery location specified in the Schedule of Requirements.</p> <p>No separate payment shall be made for the incidental services to delivery of the goods to their final destination i.e. Procuring Agency's Site(s).</p>
7.	15.6 (b)	<p>For goods offered from abroad the price quoted shall be:</p> <p>Not Applicable</p>
8.	15.8	The price shall be fixed.
9.	16.1 (a)	<p>a) For goods and related services originating or delivering within Pakistan, the currency of the Bid shall be Pakistan Rupee.</p> <p>b) For goods and related services that the Bidder will deliver from outside Pakistan: Not Applicable</p>
10.	17.1	The Bid Validity period shall be 60 days.
11.	18.1	<p>The amount of Bid Security shall be Rs. 36,000/- fixed.</p> <p>The currency of the Bid Security shall be: Pakistan Rupee</p>
12.	18.3	<p>The Bid Security shall be in favor of Procuring Agency in the form of: either pay order / demand draft (cheque will not be entertained) in favor of "Pakistan Security Printing Corporation (Pvt.) Ltd." or in the form of an unconditional Bank Guarantee enforceable in Pakistan, or insurance guarantee (PACRA Rating "AAA, AA++"). The document of bid security will be subject to verification.</p> <p>The earnest money of un-successful bidders will be returned after 5 days of posting of Final Evaluation Report on EPADS and PPRA.</p>



13.	18.3 I	Another Security: Not Applicable.
14.	19.1	Alternative Bids to the requirements of the Bidding Documents will not be permitted.
15.	21.1	The number of copies of the Bid to be completed and returned shall be None.
16.	21.2	Duly notarized Power of Attorney authorizing the signatory of the Bidder to submit the Bid.
17.	21.2	Written confirmation of authorization to be provided by the bidder. (if applicable)
4. SUBMISSION OF BIDS		
18.	22.2 (a)	To be submitted using EPADS on or before deadline.
19.	22.2 (b)	Title of the subject Procurement or Project name: (1) Rechargeable Battery 6V (2) Dry Charged Battery 12V – 200N 200 AH (As per BOQ/Specifications) ITB title and No: Tender # LP/T-2406/26/NB
20.	23.1	The deadline for Bid submission is: Thursday, April 30, 2026. 11:00 AM
5. OPENING AND EVALUATION OF BIDS		
21.	26.1	Bids will be opened using EPADS on: Thursday, April 30, 2026. 11:30 AM Bids will be opened using EPADS in presence of the bidder(s), who desire to attend. Conditional / incomplete bid document will not be considered. In case of any unforeseen reasons, unrest or force majeure, which may cause delay on the bid opening date, the bids shall be opened on the next working day at the same place and time.
22.	27	Information relating to evaluation of bids and recommendations concerning to award of the contract shall not be disclosed by the Procuring Agency to the bidders or to any other person who is not officially concerned with the process, until the announcement of the result of evaluation. The Bidder shall not disclose or attempt to make public any information relating to the bidding documents, bidding process and award of the contract to any person or entity without the Procuring Agency's prior written consent.



		In case of any disclosure related to the bidding process and contractual obligations at any stage by any bidder, the Procuring Agency may reject its bid and/or terminate the contract.
23.	32.2	The currency that shall be used for Bid evaluation and comparison purposes is: Pakistani Rupees.
24.	33.4 (h)	Other specific criteria are Nil
25.	33.5 (b)	Delivery schedule: The goods covered under this invitation are required to be delivered (shipped) within an acceptable range of weeks specified in the Schedule of Requirement. No credit will be given to earlier deliveries, and Bids offering delivery beyond this range will be treated as non-responsive.
26.	33.5 I (ii)	Deviation in payment schedule is Not Applicable.
27.	33.5 (d)	Cost of spare parts. Not applicable
28.	33.5I	Spare parts and after sales service facilities in Pakistan. The Bidder shall be required to provide an undertaking that they will ensure to supply spare parts as per BOQ / Technical Specification. (if applicable)
29.	33.5 (f)	Operating and maintenance costs. Not applicable
30.	33.5 (g)	Performance and productivity of Equipment Items offered shall have a minimum productivity specified under the relevant provision to be considered responsive as specified in the Technical Specifications.
31.	33.5 (h)	Specific additional criteria to be used in the evaluation and their evaluation method or reference to the Technical Specifications is Not Applicable.
32.	33.6	In case of award to a single Bidder of multiple lots; the methodology of evaluation to determine the lowest evaluated Lot combinations, including any discounts offered in the Form of Bid is:- Bidder(s) shall submit bid for Complete Requirement, evaluation of bids and award of contract(s) will be made for the Complete Requirement as specified in bid evaluation criteria.
33.	34.1	Domestic preference Not Applicable.
34.	35	Evaluation Techniques Least Cost Based Selection (LCBS) After meeting the requirements of eligibility, qualification and substantial responsiveness, the bid in compliance with all the mandatory (technical) specifications/requirements and/or requisite



		quality threshold (if any), and having lowest evaluated cost (or financial proposal) shall be considered highest ranked bid (Most Advantageous Bid). The most advantageous evaluated responsive bid as per our BOQ / Specification / Sample and meeting all other terms & conditions of bid documents.
6. AWARD OF CONTRACT		
35.	40.1	Percentage for quantity increase or decrease is 15% .
36.	41	Letter of acceptance may please be read as Purchase Order.
37.	43.2	i) The Performance Guarantee shall be in the form of an unconditional Bank Guarantee enforceable in Pakistan, or insurance guarantee (<i>PACRA Rating "AAA, AA++"</i>) or as per Performance Guarantee form specified in the Bidding Documents. The guarantee must be valid for a period exceeding 28 days after completion of contract. ii) The bidder will submit the performance guarantee within 10 days of the issuance of Letter of Intent. Already submitted earnest money will be released upon receipt of performance guarantee.
38.	44.1	The Advance Payment is not Applicable.
39.	44.2	The Advance Payment is not Applicable.
40.	45.1	In case of any dispute and difference which may arise in connection with the execution of the contract, the matter shall be referred to Managing Director of Corporation, who shall take decision in the matter. In case the dispute remains unresolved, the matter will be resolved through arbitration as per the Arbitration Act, 1940.
7. REVIEW OF PROCUREMENT DECISIONS		
41.	48.1	The address of the Procuring Agency Chairman (Grievance Redressal Committee) Pakistan Security Printing Corporation (Pvt.) Ltd Jinnah Avenue, Malir Halt, Karachi – Pakistan
	48.6	The Address of PPRA to submit a copy of grievance: Grievance Redressal Appellate Committee, Public Procurement Regulatory Authority 1 st Floor, G-5/2, Islamabad, Pakistan Tel: +92-51-9202254



SECTION IV: ELIGIBLE COUNTRIES

All the bidders are allowed to participate in the subject procurement without regard to nationality, except bidders of some nationality, prohibited in accordance with policy of the Federal Government.

Following countries are ineligible to participate in the procurement process:

1. India
2. Israel

Ministry of Interior, Government of Pakistan has notified List of Business-Friendly Countries (BVL). Information can be accessed through following link:

<http://www.dgip.gov.pk/Files/Visa%20Categories.aspx#L>



**SECTION V: SCHEDULE OF REQUIREMENTS, TECHNICAL
SPECIFICATIONS**



Commencement of Work/Delivery

The delivery schedule expressed as days stipulates hereafter a delivery date which is the date of delivery required.

Delivery Schedule:

- Within 30 days from the date of contract award.

Technical Specifications

1. Scope of Project and Requirements:

The Pakistan Security Printing Corporation (Pvt.) Ltd. Intends to procure **(1) Rechargeable Battery 6V (2) Dry Charged Battery 12V – 200N 200 AH (As per BOQ/Specifications)**

1.1. Delivery:

Delivery will be considered accomplished when offered Items will be delivered at Procuring Agency's site i.e. PSPC Malir Halt Karachi as per schedule of requirement.

1.2. Installation (if any):

Installation will be considered accomplished when offered Items will be installed at Procuring Agency's site i.e. PSPC Malir Halt Karachi as per requirement specified in BOQ.

1.3. Integration (if any):

Integration means that all the necessary configuration of the offered Items is according to the Procuring Agency's requirement and ready for the use.

1.4. Operational Acceptance (if any):

Operational Acceptance means that the offered machine has been installed, configured, integrated and operational after testing in accordance with the standard procedure provided by the OEM.

1.5. Training & Documentation (if any):

The bidder will provide formal hands-on training and documentation as specified in BOQ.

1.6. Factory Acceptance Test & Site Acceptance Test (if any):

The bidder will provide FAT & SAT as specified in BOQ.

Technical Requirements/Specifications

Sr. #	Item Name	Qty.	Bidder's Technical Offering Specification / details
1.	Supply of Rechargeable Battery 6V (As per BOQ / Details) Make: Torjan/Eqv.	08 Nos.	
2.	Supply of Dry Charged Battery 12V – 200N 200 AH	08 Nos.	

Note: - Bidder shall be filled the offering description / specification in above column or submit separate sheet along with pictures.

Implementation Schedule

- Within 30 days from the date of contract award.



DATA SHEET

MOTIVE T-125

MODEL T-125 with Bayonet Cap
 VOLTAGE 6
 MATERIAL Polypropylene
 DIMENSIONS Inches (mm)
 BATTERY Deep-Cycle Flooded/Wet Lead-Acid Battery
 COLOR Maroon
 WATERING HydroLink™ Watering System



WITH T₂ TECHNOLOGY



6 VOLT

PHYSICAL SPECIFICATIONS

BCI	MODEL NAME	VOLTAGE	CELL(S)	TERMINAL TYPE ⁶	DIMENSIONS ⁶ INCHES (mm)			WEIGHT ⁶ LBS. (kg)
					LENGTH	WIDTH	HEIGHT ⁷	
GC2	T-125	6	3	1, 2, 3, 4	10.30 (262)	7.13 (181)	11.15 (283)	66 (30)

ELECTRICAL SPECIFICATIONS

CRANKING PERFORMANCE		CAPACITY ⁸ MINUTES		CAPACITY ⁹ AMP-HOURS (Ah)				ENERGY (kWh)	INTERNAL RESISTANCE (mΩ)	SHORT CIRCUIT CURRENT (amps)
C.C.A. ⁹ @ 0°F (-18°C)	C.A. ⁸ @ 32°F (0°C)	@ 25 Amps	@ 75 Amps	5-Hr	10-Hr	20-Hr	100-Hr	100-Hr		
—	—	488	132	195	221	240	266	1.60	—	—

CHARGING INSTRUCTIONS

CHARGER VOLTAGE SETTINGS (AT 77°F/25°C)					
SYSTEM VOLTAGE	6V	12V	24V	36V	48V
Bulk Charge	7.41	14.82	29.64	44.46	59.28
Float Charge	6.75	13.50	27.00	40.50	54.00
Equalize Charge	8.10	16.20	32.40	48.60	64.80

Do not install or charge batteries in a sealed or non-ventilated compartment. Constant under or overcharging will damage the battery and shorten its life as with any battery.

CHARGING TEMPERATURE COMPENSATION

ADD	SUBTRACT
0.005 volt per cell for every 1°C below 25°C 0.0028 volt per cell for every 1°F below 77°F	0.005 volt per cell for every 1°C above 25°C 0.0028 volt per cell for every 1°F above 77°F

OPERATIONAL DATA

OPERATING TEMPERATURE	SELF DISCHARGE
-4°F to 113°F (-20°C to +45°C). At temperatures below 32°F (0°C) maintain a state of charge greater than 60%.	5 – 15% per month depending on storage temperature conditions.

RECYCLE RESPONSIBLY



STATE OF CHARGE MEASURE OF OPEN-CIRCUIT VOLTAGE

PERCENTAGE CHARGE	SPECIFIC GRAVITY	CELL	6 VOLT
100	1.277	2.122	6.37
90	1.258	2.103	6.31
80	1.238	2.083	6.25
70	1.217	2.062	6.19
60	1.195	2.040	6.12
50	1.172	2.017	6.05
40	1.148	1.993	5.98
30	1.124	1.969	5.91
20	1.098	1.943	5.83
10	1.073	1.918	5.75



TROJAN T-125 PERFORMANCE

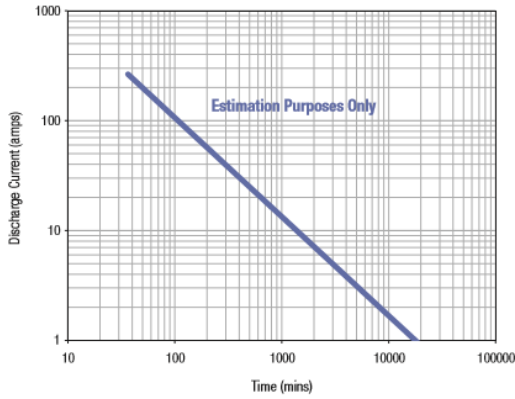

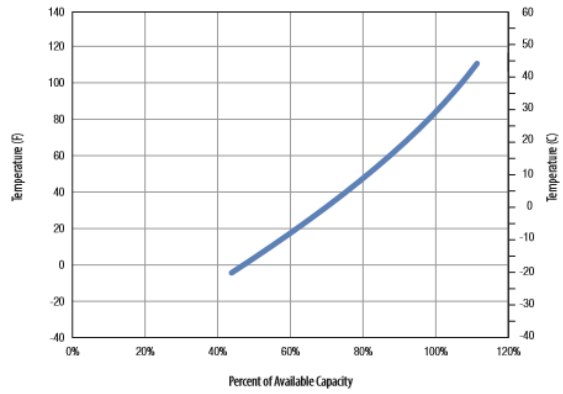

PERCENT CAPACITY VS. TEMPERATURE

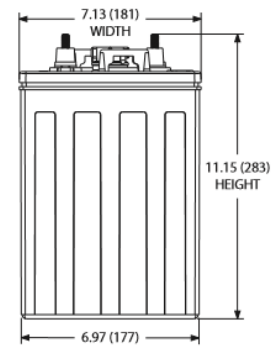
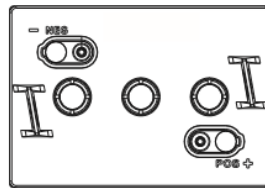
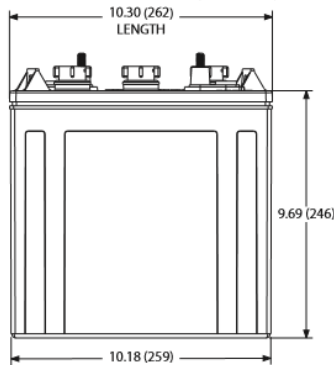

BATTERY DIMENSIONS (shown with EHT)



TERMINAL CONFIGURATIONS⁶

1	ELPT	EMBEDDED LOW PROFILE TERMINAL	2	EHPT	EMBEDDED HIGH PROFILE TERMINAL
	Terminal Height Inches (mm) 1.22 (31) Torque Values in-lb (Nm) 95 – 105 (11 – 12) Bolt 5/16"			Terminal Height Inches (mm) 1.50 (38) Torque Values in-lb (Nm) 95 – 105 (11 – 12) Bolt 5/16"	
	Terminal Height Inches (mm) 0.95 (24) Torque Values in-lb (Nm) 50 – 70 (5.6 – 7.9)			Terminal Height Inches (mm) 1.10 (28) Torque Values in-lb (Nm) 95 – 105 (11 – 12) Bolt 5/16"	

A. The number of minutes a battery can deliver when discharged at a constant rate at 80°F (27°C) and maintain a voltage above 1.75 Volt. Capacities are based on peak performance.
 B. The amount of amp-hours (Ah) a battery can deliver when discharged at a constant rate at 80°F (27°C) and maintain a voltage above 1.75 Volt. Capacities are based on peak performance.
 C. Dimensions may vary depending on type of handle or terminal. Batteries should be mounted with 0.5 inches (12.7 mm) spacing minimum.
 D. C.C.A. (Cold Cranking Amps) - the discharge load in amperes which a new, fully charged battery can maintain for 30 seconds at 0°F (-18°C) at a voltage above 1.2 Volt.

E. C.A. (Cranking Amps) - the discharge load in amperes which a new, fully charged battery can maintain for 30 seconds at 32°F (0°C) at a voltage above 1.2 Volt. This is sometimes referred to as marine cranking amps @ 32°F or M.C.A. @ 32°F.
 F. Height taken from bottom of the battery to the highest point on the battery. Heights may vary depending on type of terminal.
 G. Terminal images are representative only.
 H. Weight may vary.



TROJAN BATTERY COMPANY WITH QUALITY SYSTEM CERTIFIED BY DNV - ISO 9001:2015

Designed in compliance with applicable BCI, DIN, BS and IEC standards. Tested in compliance to BCI and IEC standards.



800.423.6569 / +1.562.236.3000 / trojanbattery.com

T-125_DS_012220

© 2020 Trojan Battery Company, LLC. All rights reserved. Trojan Battery Company is not liable for damages that may result from any information provided in or omitted from this publication, under any circumstances. Trojan Battery Company reserves the right to make adjustments to this publication at any time, without notice or obligation.



**SECTION VI – STANDARD FORMS FOR
(Single Stage One Envelope Procedure)**



Table of Forms

Sr. No.	Form No.	Description
1	Form 1	Form of bid
2	Form 2	Bidder's Eligibility / Qualification Criteria
3	Form 3	Affidavit for Bidder's Blacklisting Status
4	Form 4	Declaration for Beneficial Ownership
5	Form 5	Manufacturer's Authorization Form
6	Form 6	Form of Bid Security
7	Form 7	Price Schedule

Form 1: Form of Bid

Date:

To: Gentlemen and/or Ladies:

Having examined the Bidding Documents including Addenda Nos: *[insert numbers]*, the receipt of which is hereby duly acknowledged, we, the undersigned, offer to deliver *[description of goods and services]* in conformity with the said Bidding Documents for the sum of *[total Bid Amount in words and figures]* or such other sums as may be ascertained in accordance with the Schedule of Prices attached herewith and made part of this Bid.

We declare that our Bidding price did not involve agreements with other Bidders for the purpose of Bid suppression.

We are hereby confirming *[insert the name of the Appointing Authority]*, to be the Appointing Authority, to appoint the adjudicator in case of any arisen disputes in accordance with **ITB Clause 45.1**

We undertake, if our Bid is accepted, to deliver the goods in accordance with the delivery schedule specified in the Schedule of Requirements.

If our Bid is accepted, we undertake to provide a Performance Security (or Guarantee) in the form, in the amounts, and within the times specified in the Bidding Documents.

We declare that, as Bidder(s) we do not have conflict of interest with reference to **ITB Clause 3.7.**

We agree to abide by this Bid for the Bid Validity Period specified in **BDS 19**, and it shall remain binding upon us and may be accepted at any time before the expiration of that period.

We are not participating, as Bidders, in more than one Bid in this Bidding process, other than alternative offers in accordance with the Bidding Documents.

Our firm, its affiliates or subsidiaries – including any subcontractors or suppliers for any part of the contract – has not been declared ineligible by the Government of Pakistan under Pakistan's laws or official regulations.

Until a formal Contract is prepared and executed, this Bid, together with your written acceptance thereof and your notification of award, shall constitute a binding Contract between us.

We understand that you are not bound to accept the lowest or any Bid you may receive.

We certify/confirm that we comply with the eligibility requirements as per **ITB Clause 3** of the Bidding Documents

Dated this _____ day of _____ 20_____.

(Name) _____

[signature]

[in the capacity of]

Duly authorized to sign Bid for and on behalf of _____



Form 2 – Bidder's Eligibility / Qualification Criteria

[The Bidder shall fill in this Form in accordance with the instructions indicated below. No alterations to its format shall be permitted and no substitutions shall be accepted.]

ITB No: Tender # LP/T-2406/26/NB

Title: (1) Rechargeable Battery 6V (2) Dry Charged Battery 12V – 200N 200 AH (As per BOQ/Specifications)

Bidder: [Name of Applicant / Entity]

#	Eligibility / Qualification Criteria	Means of Verifications	Reference in Bid**	Bidder's Assessment (Y/N)
a.	This invitation for Bids is open to all reputed manufacturer / contractors / suppliers.	Attach copy of valid NTN certificate.		
b.	Bidders should not be under a declaration of ineligibility for corrupt and fraudulent practices issued by any Government (Federal, Provincial), a local and international body or a public sector organization.	Undertaking on N.J stamp paper (Value of stamp paper should be as per required value as per stamp duty act)		
c.	They must be registered with tax authorities and are active tax payers.	Attach copy of valid GST certificate and reference of Active Taxpayer list of FBR.		
d.	The bidder and their deputed staff must submit an undertaking to comply with PSPC's Code of Conduct, using the prescribed format provided in the tender document.	Undertaking as per format provided in tender document on company letter head		
e.	The bidder must submit an undertaking to comply with all applicable HSE laws, regulations and industry standards; and with all HSE requirements of PSPC, using the prescribed format provided in the tender document	Undertaking as per format provided in tender document on company letter head		
f.	<i>Any regular employee, contractual, or outsourced/third-party resource who are currently or were previously deputed on PSPC assignments during last 5 years are not authorized to participate in the bidding process for next 3 years either as a bidder or as a representative of any bidder/vendor. PSPC reserves the right to reject such</i>	Undertaking as per format provided in tender document on company letter head		



<i>bids at any stage of the procurement process</i>			
---	--	--	--

Seal & Signature of Bidder: _____

Date: _____



Form 3 – Affidavit for Bidder’s Blacklisting Status

ITB No: Tender # LP/T-2406/26/NB
 Title: (1) Rechargeable Battery 6V (2) Dry Charged Battery 12V – 200N 200 AH (As per BOQ/Specifications)
 Bidder: _____

[Required on non-judicial stamp paper; value of Rs: 100/- stamp paper should be as per required value as per Stamp Duty Act]

To:

Deputy General Manager (Purchase)
 Purchase Department
 Pakistan Security Printing Corporation (Pvt.) Ltd
 Jinnah Avenue, Malir Halt,
 Karachi –Pakistan

Affidavit for Bidder’s Blacklisting Status

Dear Sir,

I/We hereby confirm and declare that I/We, [Name of Applicant / Entity], has/have not been Blacklisted/Sanctioned by any Federal or Provincial Government Department, National Counter Terrorism Authority (NACTA), Agency, Organization or Autonomous Body anywhere in Pakistan during last 05 (five) years.

Detection of false declaration / statement at any stage of the entire Bidding Process / Currency of the Contract shall lead to Disqualification and forfeiture of Bid Security and/or Performance Guarantee and termination of contract.

Seal & Signature of Bidder:	_____
Date:	_____



Form 4 – Declaration for Ultimate Beneficial Owners InformationITB No: Tender # LP/T-2406/26/NBTitle: (1) Rechargeable Battery 6V (2) Dry Charged Battery 12V – 200N 200 AH (As per BOQ/Specifications)

Bidder: _____

Declaration of Ultimate Beneficial Owners Information for Public Procurement Contracts

1. Name:
2. Father's Name/Spouse's Name:
3. CNIC/NICOP/Passport no:
4. Nationality:
5. Residential address:
6. Email address:
7. Date on which shareholding, control or interest acquired in the business:
8. In case of indirect shareholding, control or interest being exercised through intermediary companies, entities or other legal persons or legal arrangements in the chain of ownership or control, following additional particulars to be provided:

1	2	3	4	5	6	7	8	9	10
Name	Legal form (Company/Limited Liability Partnership/Association of Persons/Single Member Company/ Partnership Firm/ Trust/Any other individual, body corporate (to be specified))	Date of incorporation/ registration	Name of registering authority	Business Address	Country	Email address	Percentage of shareholding, control or interest of BO in the legal person or legal arrangement	Percentage of shareholding, control or interest of legal person or legal arrangement in the Company	Identity of Natural Person who ultimately owns or controls the legal person or arrangement



9. Information about the Board of Directors (details shall be provided regarding number of shares in the capital of the company as set opposite respective names).

1	2	3	4	5	6	7	8
Name and surname (InBlock Letters)	CNIC No. (in case of foreigner, Passport No)	Father's/ Husband's Name in full	Current Nationality	Any other Nationality (ies)	Occupation	Residential address in full or the registered/ principal office address for a subscriber other than natural person	Number of shares taken by each subscriber (in figures and words)
Total number of shares taken (in figures and words)							

10. Any other information incidental to or relevant to Beneficial Owner(s).

Name & signature

(Person authorized to issue notice on behalf of the company)

Seal & Signature of Bidder:	
Date:	



Form 5 – Manufacturer’s Authorization Form

*[The Bidder shall require the Manufacturer to fill in this Form in accordance with the instructions indicated. This letter of authorization should be on the letterhead of the Manufacturer and should be signed by a person with the proper authority to sign documents that are binding on the Manufacturer. The Bidder shall include it in its Bid, if so indicated in the **BDS.**]*

Invitation No: Tender # LP/T-2406/26/NB
 Title: (1) Rechargeable Battery 6V (2) Dry Charged Battery 12V – 200N 200 AH (As per BOQ/Specifications)
 Bidder: _____

To: *[Pakistan Security Printing Corporation (Pvt.) Ltd]*

WHEREAS

We *[insert complete name of Manufacturer]*, who are official manufacturers of *[insert type of goods manufactured]*, having factories at *[insert full address of Manufacturer’s factories]*, do hereby authorize *[insert complete name of Bidder]* to submit a Bid the purpose of which is to provide the following Goods, manufactured by us *[insert name and or brief description of the Goods]*, and to subsequently negotiate and sign the Contract.

We hereby extend our full guarantee and warranty in accordance with Clause 28 of the General Conditions of Contract, with respect to the Goods offered by the above firm.

Signed: *[insert signature(s) of authorized representative(s) of the Manufacturer]*

Name: *[insert complete name(s) of authorized representative(s) of the Manufacturer]*

Title: *[insert title]*

Dated on _____ day of _____, _____ *[insert date of signing]*



Form 6 – Form of Bid Security

(Bank Guarantee)

[The bank shall fill in this Bank Guarantee Form in accordance with the instructions indicated.]

[Guarantor letterhead or SWIFT identifier code]

Beneficiary: *Pakistan Security Printing Corporation (Pvt.) Ltd*

Invitation No: Tender # LP/T-2406/26/NB

Date: *[Insert date of issue]*

BID GUARANTEE No.: *[Insert guarantee reference number]*

Guarantor: *[Insert name and address of place of issue, unless indicated in the letterhead]*

We have been informed that _____ *[insert name of the Bidder, which in the case of a joint venture shall be the name of the joint venture (whether legally constituted or prospective) or the names of all members thereof]* (hereinafter called "the Applicant") has submitted or will submit to the Beneficiary its Bid (hereinafter called "the Bid") for the execution of _____ under Request for Bids No. _____ ("the RFB").

Furthermore, we understand that, according to the Beneficiary's conditions, Bids must be supported by a Bid guarantee.

At the request of the Applicant, we, as Guarantor, hereby irrevocably undertake to pay the Beneficiary any sum or sums not exceeding in total an amount of _____ (_____) upon receipt by us of the Beneficiary's complying demand, supported by the Beneficiary's statement, whether in the demand itself or a separate signed document accompanying or identifying the demand, stating that either the Applicant:

- (a) has withdrawn its Bid during the period of Bid validity set forth in the Applicant's Letter of Bid ("the Bid Validity Period"), or any extension thereto provided by the Applicant; or
- (b) having been notified of the acceptance of its Bid by the Beneficiary during the Bid Validity Period or any extension thereto provided by the Applicant, (i) has failed to sign the contract agreement, or (ii) has failed to furnish the performance security, in accordance with the Instructions to Bidders ("ITB") of the Beneficiary's bidding document.

This guarantee will expire: (a) if the Applicant is the successful Bidder, upon our receipt of copies of the Contract agreement signed by the Applicant and the performance security issued to the Beneficiary in relation to such Contract agreement; or (b) if the Applicant is not the successful Bidder, upon the earlier of (i) our receipt of a copy of the Beneficiary's notification to the Applicant of the results of the Bidding process; or (ii) twenty-eight days after the end of the Bid Validity Period.

Consequently, any demand for payment under this guarantee must be received by us at the office indicated above on or before that date.

[Signature(s)]

Note: All italicized text is for use in preparing this form and shall be deleted from the final product.



Form 7 – Price Schedule**Invitation No:** Tender # LP/T-2406/26/NB**Title:** (1) Rechargeable Battery 6V (2) Dry Charged Battery 12V – 200N 200 AH (As per BOQ/Specifications)**Bidder:** [Name of Applicant / Entity]

Below mentioned supplies will be as per technical specification given in Section V- Technical Specification. All prices must be in **Pak Rupee**. All the quotes must be provided as per format specified below.

Sr. No.	Description	Unit	Unit Rate	GST / SST	Total Amount with Applicable Tax
1.	Supply of Rechargeable Battery 6V (As per BOQ / Details) Make: Torjan/Eqv.	08 Nos.			
2.	Supply of Dry Charged Battery 12V – 200N 200 AH	08 Nos.			
Numbers					
Grand Total Amount of Bid in - Words					

Note:

- i. Prices should be as per the format above and inclusive of all applicable taxes and duties in Pakistan.
- ii. Before filling this form kindly read the required Technical Specifications.
- iii. The prices should include the price of incidental services. No separate payment shall be made for the incidental services.

Seal & Signature of Bidder:

Date:



SECTION VII – GENERAL CONDITIONS OF THE CONTRACT



SECTION VII – GENERAL CONDITIONS OF THE CONTRACT**1. Definitions**

1.1. The following words and expressions shall have the meanings hereby assigned to them:

- a) **“Authority”** means Public Procurement Regulatory Authority.
- b) The **“Arbitrator”** is the person appointed with mutual consent of both the parties, to resolve contractual disputes as provided for in the General Conditions of the Contract **GCC Clause 31** hereunder.
- c) The **“Contract”** means the agreement entered into between the Procuring Agency and the Supplier, as recorded in the Contract Form signed by the parties, including all attachments and appendices thereto and all documents incorporated by reference therein.
- d) The **“Commencement Date”** is the date when the Supplier shall commence execution of the contract as specified in the **SCC**.
- e) **“Completion”** means the fulfillment of the related services by the Supplier in accordance with the terms and conditions set forth in the contract.
- f) **“Country of Origin”** means the countries and territories eligible under the PPRA Rules 2004 and its corresponding Regulations as further elaborated in the **SCC**.
- g) The **“Contract Price”** is the price stated in the Letter of Acceptance and thereafter as adjusted in accordance with the provisions of the Contract.
- h) **“Defective Goods”** are those goods which are below standards, requirements or specifications stated by the Contract.
- i) **“Delivery”** means the transfer of the goods from the supplier equipment, machinery, and /or other materials which the Supplier is required to supply to the Procuring Agency under Contract.
- j) **“Effective Contract date”** is the date shown in the Certificate of Contract Commencement issued by the Procuring Agency upon fulfillment of the conditions precedent stipulated in **GCC Clause 3**.
- k) **“Procuring Agency”** means the person named as Procuring Agency in the **SCC** and the legal successors in title to this person, procuring the Goods and related service, as named in **SCC**.
- l) **“Related Services”** means those services ancillary to the delivery of the Goods, such as transportation and insurance, and any other incidental services, such as installation, commissioning, provision of technical assistance, training, initial maintenance and other such obligations of the Supplier



- covered under the Contract.
- m) **"GCC"** means the General Conditions of Contract contained in this section.
 - n) **"Intended Delivery Date"** is the date on which it is intended that the Supplier shall affect delivery as specified in the **SCC**.
 - o) **"SCC"** means the Special Conditions of Contract.
 - p) **"Supplier"** means the individual private or government entity or a combination of the above whose Bid to perform the contract has been accepted by the Procuring Agency and is named as such in the Contract Agreement, and includes the legal successors or permitted assigns of the supplier and shall be named in the **SCC**.
 - q) **"Project Name"** means the name of the project stated in **SCC**.
 - r) **"Day"** means calendar day.
 - s) **"Eligible Country"** means the countries and territories eligible for participation in accordance with the policies of the Federal Government.
 - t) **"End User"** means the organization(s) where the goods will be used, as named in the **SCC**.
 - u) **"Origin"** means the place where the Goods were mined, grown, or produced or from which the Services are supplied. Goods are produced when, through manufacturing, processing, or substantial and major assembly of components, a commercially recognized new produce results that is substantially different in basic characteristics or in purpose or utility from its components.
 - v) **"Force Majeure"** means an unforeseeable event which is beyond reasonable control of either Party and which makes a Party's performance of its obligations under the Contract impossible or so impractical as to be considered impossible under the circumstances.
 For the purposes of this Contract, **"Force Majeure"** means an event which is beyond the reasonable control of a Party, is not foreseeable, is unavoidable, and its origin is not due to negligence or lack of care on the part of a Party, and which makes a Party's performance of its obligations hereunder impossible or so impractical as reasonably to be considered impossible in the circumstances. and includes, but is not limited to, war, riots, civil disorder, earthquake, fire, explosion, storm, flood, epidemics, or other adverse weather conditions, strikes, lockouts or other industrial action (except where such strikes, lockouts or other industrial action are within the power of the Party invoking Force Majeure to prevent), confiscation or any other action by Government agencies.
 - w) **"Specification"** means the Specification of the Goods and



	<p>performance of incidental services in accordance with the relevant standards included in the Contract and any modification or addition made or approved by the Procuring Agency.</p> <p>x) The Supplier's Bid is the completed Bid document submitted by the Supplier to the Procuring Agency.</p>
<p>2.Application and Interpretation</p>	<p>2.1 These General Conditions shall apply to the extent that they are not superseded by provisions of other parts of the Contract.</p> <p>2.2 In interpreting these Conditions of Contract headings and marginal notes are used for convenience only and shall not affect their interpretations unless specifically stated; references to singular include the plural and vice versa; and masculine include the feminine. Words have their ordinary meaning under the language of the Contract unless specifically defined.</p> <p>2.3 The documents forming the Contract shall be interpreted in the following order of priority:</p> <ol style="list-style-type: none"> (1) Form of Contract, (2) Special Conditions of Contract, (3) General Conditions of Contract, (4) Letter of Acceptance, (5) Certificate of Contract Commencement (6) Specifications (7) Contractor's Bid, and (8) Any other document listed in the Special Conditions of Contract as forming part of the Contract.
<p>3.Conditions Precedent</p>	<p>1.1 Having signed the Contract, it shall come into effect on the date on which the following conditions have been satisfied: -</p> <ol style="list-style-type: none"> i. Submission of performance Security (or guarantee) in the form specified in the SCC; ii. Furnishing of Advance Payment Unconditional Guarantee. <p>1.2 If the Condition precedent stipulated on GCC Clause 3.1 is not met by the date specified in the SCC this contract shall not come into effect;</p> <p>1.3 If the Procuring Agency is satisfied that each of the conditions precedent in this contract has been satisfied (except to the extent waved by him, but subject to such conditions as he shall impose in respect of such waiver) he shall promptly issue to the supplier a certificate of Contract commencement, which shall confirm the start date.</p>
<p>4. Governing Language</p>	<p>1.1 The Contract as all correspondence and documents relating to the contract exchanged by the Supplier and the Procuring Agency shall be written in the language specified in SCC. Subject to GCC Clause</p>



	3.1 , the version of the Contract written in the specified language shall govern its interpretation.
5. Applicable Law	1.1 The contract shall be governed and interpreted in accordance with the laws of Pakistan, unless otherwise specified in SCC.
6. Country of Origin	6.1 The origin of Goods and Services may be distinct from the nationality of the Supplier.
7. Standards	7.1 The Goods supplied under this Contract shall conform to the standards mentioned in the Technical Specifications, and, when no applicable standard is mentioned, the American Standards (such as ACI, IEEE, ASME, etc.) or the Pakistani standards such as PSQCA Such standards shall be the latest issued by the concerned institution.
8. Use of Contract Documents and Information; Inspection and Audit by Government of Pakistan	<p>8.1 The Supplier shall not, without the Procuring Agency's prior written consent, disclose the Contract, or any provision thereof, or any specification, plan, drawing, pattern, sample, or information furnished by or on behalf of the Procuring Agency in connection therewith, to any person other than a person employed by the Supplier in the performance of the Contract. Disclosure to any such employed person shall be made in confidence and shall extend only as far as may be necessary for purposes of such performance.</p> <p>8.2 The Supplier shall not, without the Procuring Agency's prior written consent, make use of any document or information enumerated in GCC Clause 7.1 except for purposes of performing the Contract.</p> <p>8.3 Any document, other than the Contract itself, enumerated in GCC Clause 7.1 shall remain the property of the Procuring Agency and shall be returned (all copies) to the Procuring Agency on completion of the Supplier's performance under the Contract if so required by the Procuring Agency.</p> <p>8.4 The Supplier shall permit the Government of Pakistan or / and donor agencies involved in financing the project to inspect the Supplier's accounts and records relating to the performance of the Supplier and to have them audited by auditors appointed by the Government of Pakistan or / and the appropriate donor agencies, if so required by the Government of Pakistan or / and the appropriate donor agencies.</p>
9. Patents and Copy Rights	<p>9.1 The Supplier shall indemnify the Procuring Agency against all third-party claims of infringement of patent, trademark, or industrial design rights arising from use of the Goods or any part thereof in Pakistan.</p> <p>9.2 The patent right in all drawings, documents, and other materials containing data and information furnished to the Procuring Agency by the Supplier herein shall remain vested in the supplier, or, if they are furnished to the Procuring Agency directly, or through the Supplier by any third party, including suppliers of materials, the</p>



		patent right in such materials shall remain vested in such third party.
10. Performance Security (or Guarantee)	10.1	The Performance Security (or Guarantee) shall be provided to the Procuring Agency no later than the date specified in the Letter of Acceptance and shall be issued in an amount and form and by a bank or surety acceptable to the Procuring Agency, and denominated in the types and proportions of the currencies in which the Contract Price is payable as specified in the SCC .
	10.2	The proceeds of the Performance Security (or Guarantee) shall be payable to the Procuring Agency as compensation for any loss resulting from the Supplier's failure to complete its obligations under the Contract.
	10.3	The Performance Security (or Guarantee) shall be in one of the following forms <ul style="list-style-type: none"> a) A bank guarantee, an irrevocable letter of credit issued by a reputable bank, or in the form provided in the Bidding Documents or another form acceptable to the Procuring Agency; or b) A cashier's or certified check.
	10.4	The performance security (or guarantee) will be discharged by the Procuring Agency and returned to the Supplier not later than thirty (30) days following the date of completion of the Supplier's performance obligations under the Contract, including any warranty obligations, unless otherwise specified in SCC .
11. Inspection and Testing	11.1	The Procuring Agency or its representative shall have the right to inspect and /or to test the Goods to confirm their conformity to the Contract specifications at no extra cost to the Procuring Agency. SCC and the Technical Specifications shall specify what inspections and tests the Procuring Agency shall notify the Supplier in writing or in electronic forms that provide record of the content of communication, in a timely manner, of the identity of any representatives retained for these purposes.
	11.2	The inspections and tests may be conducted on the premises of the Supplier or its subcontractor(s), at point of delivery, and/or at the Goods' final destination. If conducted on the premises of the Supplier or its subcontractor(s), all reasonable facilities and assistance, including access to drawings and production data, shall be furnished to the inspectors at no charge to the Procuring Agency.
	11.3	Should any inspected or tested Goods fail to conform to the Specifications, the Procuring Agency may reject the Goods, and the Supplier shall replace the rejected Goods to meet specification requirements free of cost to the Procuring Agency.



	<p>11.4 The Procuring Agency's right to inspect, test and, where necessary, reject Goods after the Goods' arrival in the Procuring Agency's country shall in no way be limited or eared by reason of the Goods having previously been inspected, tested, and passed by the Procuring Agency or its representative prior to the Goods' shipment from the country of origin.</p> <p>11.5 Nothing in GCC Clause 10 shall in any way release the supplier from any warranty or other obligations under this Contract.</p>
12. Packing	<p>12.1 The supplier shall provide such packing of the Goods as is required to prevent their damage or deterioration during transit to their final destination, as indicated in the Contract. The packing shall be sufficient to withstand, without limitation, rough handling during transit and exposure to extreme temperatures, salt and precipitation during transit, and open storage. Packing case size and weights shall take into consideration, where appropriate, the remoteness of the Goods final destination and the absence of heavy handling facilities at all points in transit.</p> <p>12.2 The packing, marking, and documentation within and outside the packages shall comply strictly with such special requirements as shall be expressly provided for in the Contract, including additional requirements, if any, specified in SCC, and in any subsequent instructions ordered by the Procuring Agency.</p>
13. Delivery and Documents	<p>13.1 Delivery of the Goods shall be made by the Supplier in accordance with the terms specified in the Schedule of Requirements. The details of shipping and or other documents to be furnished by the Supplier as specified in SCC.</p> <p>13.2 For purposes of the Contract, "EXW", "FOB", "FCA", "CIF", "CIP," and other trade terms used to describe the obligations of the parties shall have the meanings assigned to them by the current edition of INCOTERMS published by the International Chamber of Commerce, Paris.</p> <p>13.3 Documents to be submitted by the Supplier are specified in SCC.</p>
14. Insurance	<p>14.1 The Goods supplied under the Contract shall be fully insured in a freely convertible currency against loss or damage incidental to manufacture or acquisition, transportation, storage, and delivery in the manner specified in the SCC.</p>
15. Transportation	<p>15.1 Where the Supplier is required under Contract to deliver the Goods FOB, transport of the Goods, up to and including the point of putting the Goods on board the vessel at the specified port of loading, shall be arranged and paid for by the Supplier, and the cost thereof shall be included in the Contract Price. Where the Supplier is required under the Contract to deliver the Goods FCA, transport of the Goods and delivery into the custody of the carrier at the place named by</p>



	<p>the Procuring Agency or other agreed point shall be arranged and paid for by the Supplier, and the cost thereof shall be included in the Contract Price.</p> <p>15.2 Where the Supplier is required under Contract to deliver the Goods CIF or CIP, transport of the Goods to the port of destination or such other named place of destination in Pakistan, as shall be specified in the Contract, shall be arranged and paid for by the Supplier, and the cost thereof shall be included in the Contract Price</p> <p>15.3 Where the Supplier is required under the Contract to transport the Goods to a specified place of destination within Pakistan, defined as the Project Site, transport to such place of destination in Pakistan, including insurance and storage, as shall be specified in the Contract, shall be arranged by the Supplier, and related costs shall be included in the Contract Price.</p>
<p>16. Related Services</p>	<p>16.1 The Supplier may be required to provide any or all of the following services, including additional services, if any, specified in SCC:</p> <ul style="list-style-type: none"> a) Performance or supervision of on-site assembly, Installation Commissioning and/or start-up of the supplied Goods; b) Furnishing of tools required for assembly and/or maintenance of the supplied Goods; c) Furnishing of a detailed operations and maintenance manual for each appropriate unit of the supplied Goods; d) Performance or supervision or maintenance and/or repair of the supplied Goods, for a period of time agreed by the parties, provided that this service shall not relieve the Supplier of any warranty obligations under this Contract; and e) Training of the Procuring Agency's personnel, at the Supplier's plant and/or on-site, in assembly, start-up, operation, maintenance, and/or repair of the supplied Goods. <p>16.2 Prices charged by the Supplier for related services, if not included in the Contract Price for the Goods, shall be agreed upon in advance by the parties and shall not exceed the prevailing rates charged to other parties by the Supplier for similar services.</p>
<p>17. Spare Parts</p>	<p>17.1 As specified in SCC, the Supplier may be required to provide any or all of the following materials, notifications, and information pertaining to spare parts manufactured or distributed by the Supplier:</p> <ul style="list-style-type: none"> a) Such spare parts as the Procuring Agency may elect to purchase from the Supplier, provided that this election shall not relieve the Supplier of any warranty obligations under the Contract; and



	<p>b) In the event of termination of production of the spare parts:</p> <p>i) advance notification to the Procuring Agency of the pending termination, in sufficient time to permit the Procuring Agency to procure needed requirements; and</p> <p>ii) following such termination, furnishing at no cost to the Procuring Agency, the blueprints, drawings, and specifications of the spare parts, if requested.</p>
<p>18. Warranty / Defect Liability Period</p>	<p>18.1 The Supplier warrants that the Goods supplied under the Contract are new, unused, of the most recent or current models and that they incorporate all recent improvements in design and materials unless provided otherwise in the Contract. The Supplier further warrants that all Goods supplied under this Contract shall have no defect, arising from design, materials, or workmanship (except when the design and/or material is required by the Procuring Agency, specifications) or from any act or omission of the Supplier, that may develop under normal use of the supplied Goods in the conditions prevailing in Pakistan.</p> <p>18.2 This warranty shall remain valid for a period specified in the SCC after the Goods, or any portion thereof as the case may be, have been delivered to and accepted at the final destination indicated in the Contract, or for a period specified in the SCC after the date of shipment from the port or place of loading in the source country, +whichever period concludes earlier, unless specified otherwise in SCC.</p> <p>18.3 The Procuring Agency shall promptly notify the Supplier in writing or in electronic forms that provide record of the content of communication of any claims arising under this warranty.</p> <p>18.4 Upon receipt of such notice, the Supplier shall, within the period specified in SCC and with all reasonable speed, repair or replace the defective Goods or parts thereof, without costs to the Procuring Agency other than, where applicable, the cost of inland delivery of the repaired or replaced Goods or parts from EXW or the port or place of entry to entry to the final destination.</p> <p>18.5 If the Supplier, having been notified, fails to remedy the defect(s) within the period specified in SCC, the Procuring Agency may proceed to take such remedial action as may be necessary, at the Supplier's risk and expense and without prejudice to any other rights which the Procuring Agency may have against the Supplier under the Contract.</p>



<p>19. Payment</p>	<p>19.1 The method and conditions of payment to be made to the Supplier under this Contract shall be specified in SCC.</p> <p>19.2 The Supplier's request(s) for payment shall be made to the Procuring Agency in writing or in electronic forms that provide record of the content of communication, accompanied by an invoice describing, as appropriate, the Goods delivered and Services performed, and by documents submitted pursuant to GCC Clause 13, and upon fulfillment of other obligations stipulated in the Contract.</p> <p>19.3 Payments shall be made promptly by the Procuring Agency, within sixty (60) days after submission of an invoice or claim by the Supplier. If the Procuring Agency makes a late payment, the Supplier shall be paid interest on the late payment. Interest shall be calculated from the date by which the payment should have been made up to the date when the late payment is made at the rate as specified in the SCC.</p> <p>19.4 The currency or currencies in which payment is made to the Supplier under this Contract shall be specified in SCC subject to the following general principle: payment will be made in the currency or currencies in which the payment has been requested in the Supplier's Bid.</p> <p>19.5 All payments shall be made in the currency or currencies specified in the SCC pursuant to GCC Clause 19.4</p>
<p>20. Prices</p>	<p>20.1 The contract price shall be as specified in the Contract Agreement Subject to any additions and adjustments thereto or deductions there from, as may be made pursuant to the Contract.</p> <p>20.2 Prices charged by the Supplier for Goods delivered and Services performed under the Contract shall not vary from the prices quoted by the Supplier in its Bid, with the exception of any price adjustments authorized in SCC or in the Procuring Agency's request for Bid Validity extension, as the case may be.</p>
<p>21. Change Orders</p>	<p>21.1 The Procuring Agency may at any time, by a written order given to the Supplier pursuant to GCC Clause 22, make changes within the general scope of the Contract in any one or more of the following:</p> <ul style="list-style-type: none"> a) Drawings, designs, or specifications, where Goods to be furnished under the Contract are to be specifically manufactured for the Procuring Agency; b) The method of shipment or packing; c) The place of delivery; and/or d) The Services to be provided by the Supplier. <p>21.2 If any such change causes an increase or decrease in the cost of, or the time required for, the Supplier's performance of any provisions under the Contract an equitable adjustment shall be</p>



	<p>made in the Contract Price or delivery schedule, or both, and the Contract shall accordingly be amended. Any claims by the Supplier for adjustment under this clause must be asserted within thirty (30) days from the date of the Supplier's receipt of the Procuring Agency change order.</p> <p>21.3 Prices to be charged by the supplier for any related services that might be needed but which were not included in the Contract shall be agreed upon in advance by the Parties and shall not exceed the prevailing rates charged to other parties by the Supplier for similar services</p>
22. Contract Amendments	22.1 Subject to GCC Clause 20 , no variation in or modification of the terms of the Contract shall be made except by written amendment signed by the parties.
23. Assignment	23.1 Neither the Procuring Agency nor the Supplier shall assign, in whole or in part, obligations under this Contract, except with the prior written consent of the other party.
24. Sub-Contracts	<p>24.1 The Supplier shall consult the Procuring Agency in the event of subcontracting under this contract if not already specified in the Bid. Subcontracting shall not alter the Supplier's obligations.</p> <p>24.2 Subcontracts must comply with the provision of GCC Clause 5.</p>
25. Delays in the Supplier's Performance	<p>25.1 Delivery of the Goods and performance of Services shall be made by the Supplier in accordance with the time schedule prescribed by the Procuring Agency in the Schedule of Requirements.</p> <p>25.2 If at any time during performance of the Contract, the Supplier or its subcontractor(s) should encounter conditions impeding timely delivery of the Goods and performance of Services, the Supplier shall promptly notify the Procuring Agency in writing or in electronic forms that provide record of the content of communication of the fact of the delay, its likely duration and its cause(s). As soon as practicable after receipt of the Supplier's notice, the Procuring Agency shall evaluate the situation and may at its discretion extend the Supplier's time for performance, with or without liquidated damages, in which case the extension shall be ratified by the parties by amendment of Contract.</p> <p>25.3 Except as provided under GCC Clause 28, a delay by the Supplier in the performance of its delivery obligations shall render the Supplier liable to the imposition of liquidated damages pursuant to GCC Clause 26, unless an extension of time is agreed upon pursuant to GCC Clause 25.2 without the application of liquidated damages.</p>
26. Liquidated Damages	26.1 Subject to GCC Clause 28 , if the Supplier fails to deliver any or all of the Goods or to perform the Services within the period(s)



	<p>specified in the Contract, the Procuring Agency shall, without prejudice to its other remedies under the Contract, deduct from the Contract Price, as liquidated damages, a sum equivalent to the percentage specified in SCC of the delivered price of the delayed Goods or unperformed Services for each week or part thereof of delay until actual delivery or performance, up to a maximum deduction of the performance security (or guarantee) specified in SCC. Once the said maximum is reached, the Procuring Agency may consider termination of the Contract pursuant to GCC Clause 26.</p>
<p>27. Termination for Default</p>	<p>27.1 The Procuring Agency or the Supplier, without prejudice to any other remedy for breach of Contract, by written notice of default sent to the concerned party may terminate the Contract if the other party causes a fundamental breach of the Contract.</p> <p>27.2 Fundamental breaches of Contract shall include, but shall not be limited to the following:</p> <ul style="list-style-type: none"> a) the Supplier fails to deliver any or all of the Goods within the period(s) specified in the Contract, or within any extension thereof granted by the Procuring Agency pursuant to GCC Clause 24; or b) the Supplier fails to perform any other obligation(s) under the Contract; c) Supplier's failure to submit performance security (or guarantee) within the time stipulated in the SCC; d) the supplier has abandoned or repudiated the contract. e) the Procuring Agency or the Supplier is declared bankrupt or goes into liquidation other than for a reconstruction or amalgamation; f) a payment is not paid by the Procuring Agency to the Supplier after 84 days from the due date for payment; g) the Procuring Agency gives Notice that goods delivered with a defect is a fundamental breach of Contract and the Supplier fails to correct it within a reasonable period of time determined by the Procuring Agency; and h) if the Procuring Agency determines, based on the reasonable evidence, that the Supplier has engaged in corrupt, coercive, collusive, obstructive or fraudulent practices, in competing for or in executing the Contract. <p>27.3 For the purpose of this clause: "Corrupt and Fraudulent Practice" means the practices as described in Rule-2 (1) (f) of Public Procurement Rules-2004.</p> <p>27.4 In the event the Procuring Agency terminates the Contract in whole or in part, pursuant to GCC Clause 26.1, the Procuring Agency may</p>



	<p>procure, upon such terms and in such manner as it deems appropriate, Goods or Services similar to those undelivered, and the Supplier shall be liable to the Procuring Agency for any excess costs for such similar Goods or Services. However, the Supplier shall continue performance of the Contract to the extent not terminated.</p>
28. Termination for Force Majeure	<p>28.1 Notwithstanding the provisions of GCC Clauses 25, 26, and 27, neither Party shall have any liability or be deemed to be in breach of the Contract for any delay nor is other failure in performance of its obligations under the Contract, if such delay or failure is a result of an event of Force Majeure.</p> <p>For purpose of this clause, “Force Majeure” means an event which is beyond the reasonable control of a Party, is not foreseeable, is unavoidable, and its origin is not due to negligence or lack of care on the part of a Party, and which makes a Party’s performance of its obligations hereunder impossible or so impractical as reasonably to be considered impossible in the circumstances, and includes, but is not limited to, war, riots, civil disorder, earthquake, fire, explosion, storm, flood, epidemics, or other adverse weather conditions, strikes, lockouts or other industrial action (except where such strikes, lockouts or other industrial action are within the power of the Party invoking Force Majeure to prevent</p> <p>28.2 If a Party (hereinafter referred to as “the Affected Party”) is or will be prevented from performing its substantial obligation under the contract by Force Majeure, it shall give a Notice to the other Party giving full particulars of the event and circumstance of Force Majeure in writing or in electronic forms that provide record of the content of communication of such condition and the cause thereof. Unless otherwise directed by the Procuring Agency in writing or in electronic forms that provide record of the content of communication, the Supplier shall continue to perform its obligations under the Contract as far as is reasonably practical, and shall seek all reasonable alternative means for performance not prevented by the Force Majeure event.</p>
29. Termination for Insolvency	<p>29.1 The Procuring Agency may at any time terminate the Contract by giving written notice to the Supplier if the Supplier becomes bankrupt or otherwise insolvent. In this event, termination will be without compensation to the Supplier, provided that such termination will not prejudice or affect any right of action or remedy which has accrued or will accrue thereafter to the Procuring Agency.</p>
30. Termination for Convenience	<p>30.1 The Procuring Agency, by written notice sent to the Supplier, may terminate the contract, in whole or in part, at any time for its convenience. The notice of termination shall specify that termination is for the Procuring Agency’s convenience, the Contract is terminated, and the date upon which such termination becomes</p>



	<p>effective.</p> <p>30.2 The Goods that are complete and ready for shipment within thirty (30) days after the Supplier's receipt of notice of termination shall be accepted by the Procuring Agency at the Contract terms and price. For the remaining Goods, the Procuring Agency may elect:</p> <ol style="list-style-type: none"> a) To have any portion completed and delivered at the Contract terms and prices; and / or b) To cancel the remainder and pay to the Supplier an agreed amount for partially completed Goods and Services and for materials and parts previously procured by the Supplier.
31. Disputes Resolutions	<p>31.1 In the event of any dispute arising out of this contract, either party shall issue a notice of dispute to settle the dispute amicably. The parties hereto shall, within twenty-eight (28) days from the notice date, use their best efforts to settle the dispute amicably through mutual consultations and negotiation. Any unsolved dispute may be referred by either party to an arbitrator that shall be appointed by mutual consent of the both parties.</p> <p>31.2 After the dispute has been referred to the arbitrator, within 30 days, or within such other period as may be proposed by the Parties, the Arbitrator shall give its decision. The rendered decision shall be binding to the Parties.</p>
32. Procedure for Disputes Resolutions	<p>32.1 The arbitration shall be conducted in accordance with the arbitration procedure published by the Institution named and in the place shown in the SCC.</p> <p>32.2 The rate of the Arbitrator's fee and administrative costs of arbitration shall be borne equally by the Parties. The rates and costs shall be in accordance with the rules of the Appointing Authority. In conducting arbitration to its finality each party shall bear its incurred costs and expenses.</p> <p>32.3 The arbitration shall be conducted in accordance with the arbitration procedure published by the institution named and in the place shown in the SCC.</p>
33. Replacement of Arbitrator	<p>33.1 Should the Arbitrator resign or die, or should the Procuring Agency and the Supplier agree that the Arbitrator is not functioning in accordance with the provisions of the contract, a new Arbitrator shall be appointed by mutual consent of the both parties.</p>
34. Limitation of Liability	<p>34.1 Except in cases of criminal negligence or willful conduct, and in the case of infringement pursuant to GCC Clause 8,</p> <ol style="list-style-type: none"> a) The supplier shall not be liable to the Procuring Agency, whether in contract, tort, or otherwise, for any indirect or consequential loss or damage, loss of use, loss of production,



	<p>or loss of profits or interest costs, provided that this exclusion shall not apply to any obligation of the Supplier to pay liquidated damages to the Procuring Agency; and</p> <p>b) The aggregate liability of the Supplier to the Procuring Agency, whether under the Contract, in tort or otherwise, shall not exceed the total Contract Price, provided that this limitation shall not apply to the cost of repairing or replacing defective equipment or to any obligation of the Supplier to indemnify the Procuring Agency with respect to patent infringement.</p>
<p>35. Notices</p>	<p>35.1 Any notice given by one party to the other pursuant to this Contract shall be sent to the other party in writing or in electronic forms that provide record of the content of communication and confirmed in writing or in electronic forms that provide record of the content of communication to the other party's address specified in SCC.</p> <p>35.2 A notice shall be effective when delivered or on the notice's effective date, whichever is later.</p>
<p>36. Taxes and Duties</p>	<p>36.1 A foreign Supplier shall be entirely responsible for all taxes, stamp duties, license fees, and other such levies imposed outside Pakistan.</p> <p>36.2 If any tax exemptions, reductions, allowances or privileges may be available to the Supplier in Pakistan the Procuring Agency shall use its best efforts to enable the Supplier to benefit from any such tax savings to the maximum allowable extent.</p> <p>36.3 A local Supplier shall be entirely responsible for all taxes, duties, license fees, etc., incurred until delivery of the contracted Goods to the Procuring Agency.</p>



SECTION VIII: SPECIAL CONDITIONS OF THE CONTRACT (SCC)



Special Conditions of Contract (SCC)

The following Special Conditions of Contract (SCC) shall supplement the GCC. Whenever there is a conflict, the provisions herein shall prevail over those in the GCC. The corresponding clause number of the GCC is indicated in parentheses.

SCC Clause Number	GCC Clause Number	Amendments of, and Supplements to, Clauses in the GCC
Definitions (GCC 1)		
1.	1.1	The Procuring Agency is: Pakistan Security Printing Corporation (Pvt.) Ltd
2.	1.1(p)	The Supplier is: <i>[Name and address]</i>
3.	1.1(q)	The title of the subject procurement or The Project is: (1) Rechargeable Battery 6V (2) Dry Charged Battery 12V – 200N 200 AH (As per BOQ/Specifications)
Governing Language (GCC 4)		
4.	4.1	The Governing Language shall be: English
Applicable Law (GCC 5)		
5.	5.1	The Applicable Law shall be: Laws of Pakistan
Country of Origin (GCC 6)		
6.	6.1	Country of Origin is the country where offered items is/are manufactured.
Performance Security (or guarantee) (GCC 10)		
7.	10.1	The amount of performance guarantee, as a percentage of the Contract Price, shall be: <i>[05% (five percent)] (excluding taxes & duties)</i>
8.	10.4	Successful bidder, shall submit 5% performance guarantee and the same will be released after 30 days of satisfactory supply of goods / services or completion of defect liability period if specified.
Inspections and Tests (GCC 11)		
9.	11.1	Inspection and tests prior to shipment of Goods and at final acceptance are as follows; As specified in technical specification / BOQ.



Packing (GCC Clause 12)		
10.	12.2	<p>The following SCC shall supplement GCC Clause 12.2:</p> <p>The packing shall be sea / air worthy and of international export packing standards and shall be adequately protected from damages and pilferage during shipment and transportation to site and it shall be the Bidder's responsibility to provide undamaged material in the quantities required under the Contract.</p> <p>All costs associated with packing protection must be included in the Bidding document.</p>
Delivery and Documents (GCC Clause 13)		
11.	13.1	<p>For Goods supplied from abroad: Not Applicable</p>



12.	13.3	<p>For Goods from within Pakistan: Upon delivery of the Goods to the transporter, the Supplier shall notify the Procuring Agency and mail the following documents to the Procuring Agency:</p> <ul style="list-style-type: none"> (i.) one original plus four copies of the Supplier's invoice showing Goods' description, quantity, unit price, and total amount; (ii.) delivery note, railway receipt, or truck receipt; (iii.) Manufacturer's or Supplier's warranty certificate as specified in BOQ / Technical specification; (iv.) inspection certificate issued by the nominated inspection agency, and the Supplier's factory inspection report (if desired in BOQ); and (v.) certificate of country of origin issued by Pakistan Chamber of Commerce and Industry or equivalent authority in the country of origin in duplicate (if desired in BOQ). <p>The above documents shall be received by the Procuring Agency before arrival of the Goods and, if not received, the Supplier will be responsible for any consequent expenses.</p>
Insurance (GCC Clause 14)		
13.	14.1	Not applicable.
Related Services (GCC Clause 16)		
14.	16.1	<p>Related services to be provided are:</p> <p>Supplier shall provide all the related services as per GCC-16 without any additional cost to the Procuring Agency (If required in BOQ / Technical specification).</p>
Spare Parts (GCC Clause 17)		
15.	17.1	<p>Additional spare parts requirements are:</p> <p>Supplier shall carry sufficient inventories to assure ex-stock supply of consumable spares for the Goods. Other spare parts and components shall be supplied as promptly as possible, but in any case, within six (6) months of placing the order (If required in BOQ / Technical specification).</p>
Warranty (GCC Clause 18)		



16.	18.2	<p>GCC Clause 18.2—In partial modification of the provisions, the Supplier shall, in addition, comply with the performance and/or consumption guarantees specified under the Contract. If, for reasons attributable to the Supplier, these guarantees are not attained in whole or in part, the Supplier shall, at its discretion, either:</p> <ol style="list-style-type: none"> a. make such changes, modifications, and/or additions to the Goods or any part thereof as may be necessary in order to attain the contractual guarantees specified in the Contract at its own cost and expense and to carry out further performance tests in accordance with SCC 4. b. The SUPPLIER shall pay to the BUYER at the rate of 2% per month or part of month for the value of the stores which the SUPPLIER has failed to deliver within the stipulated period, provided that damages shall not exceed 10% of the total price payable under the Purchase Contract, otherwise BUYER will make deduction from SUPPLIER'S bill.
17.	18.4 & 18.5	The period for correction of defects in the warranty period is As specified in BOQ/Technical Specification Section V.
Payment (GCC Clause 19)		
18.	19.1	<p>The method and conditions of payment to be made to the Supplier under this Contract shall be as follows:</p> <p>Payment for Goods supplied from abroad: <u>NOT APPLICABLE</u></p>
		<p>Payment for Goods and Services supplied from within Pakistan:</p> <ol style="list-style-type: none"> (i) Payment shall be made on a monthly basis after completion of the testing activities including the receiving of final report. (ii) Payment is subject to verification and acceptance by the concerned user department. (iii) Payments shall be based on actual services rendered as per the approved Bill of Quantities (BOQ). (iv) No hidden or additional charges should be included in the quotations; all types of costs must be consolidated into a single total value days after the date of the operational acceptance certificate for the respective equipment duly signed by the Procuring Agency.



19.	19.3	Rate to be used for paying the Supplier's interest on the late payment made by Procuring Agency shall be (Not Applicable)
Prices (GCC Clause 20)		
20.	20.1	Quoted Prices shall not be adjusted.
Liquidated Damages (GCC Clause 26)		
21.	25.1	The SUPPLIER shall pay to the BUYER at the rate of 2% per month or part of month for the value of the stores which the SUPPLIER has failed to deliver within the stipulated period, provided that damages shall not exceed 10% of the total price payable under the Purchase Contract, otherwise BUYER will make deduction from SUPPLIER'S bill.
Procedure for Dispute Resolution (GCC Clause 32)		
23.	32.3	<p>Dispute Resolution</p> <p>In case of any dispute and difference which may arise in connection with the execution of the contract, the matter shall be referred to Managing Director of Corporation, who shall take decision in the matter.</p> <p>In case the dispute remains unresolved, the matter will be resolved through arbitration as per the Arbitration Act, 1940.</p>
Notices (GCC Clause 35)		
26.	35.1	<p>— Procuring Agency's address for notice purposes: <i>(to be inserted at the time of contract signing)</i></p> <p>— Supplier's address for notice purposes: <i>(to be inserted at the time of contract signing)</i></p>
Tax & Duties (GCC Clause 36)		
27	36	Prices payable to the Supplier as stated in the Contract are not subject to any adjustment during performance of the contract. However, any subsequent legislation enacted, changes in the rate of any tax, levy of additional tax or duty during the currency of contract that impacts the contract price would be duly accounted for by both the parties of the contract i.e. in case of increase or decrease in the rates of the said taxes and duties or levy of any new tax or duty, the contract price would be adjusted accordingly.



		Confidentiality	
28		28.1	Information relating to evaluation of bids and recommendations concerning to award of the Contract shall not be disclosed by the Procuring Agency to the Supplier or to any other person who is not officially concerned with the process, until the announcement of the result of evaluation.
		28.2	The Supplier shall not disclose or attempt to make public any information relating to the bidding documents, bidding process and award of the Contract to any person or entity without the Procuring Agency's prior written consent.
		28.3	In case of any disclosure related to the bidding process and contractual obligations at any stage by the Supplier, the Procuring Agency may terminate the Contract.



SECTION IX: CONTRACT FORMS

(TO BE EXECUTED ON N.J. STAMP PAPER VALUING 0.35% OF PURCHASE ORDER) PURCHASE CONTRACT (SUPPLY)

This agreement made on the ____ day of _____ effective from ____ day of _____ between Messrs. _____, hereinafter referred to as SUPPLIER and Pakistan Security Printing Corporation (Pvt.) Limited, Karachi, Pakistan, hereinafter referred as BUYER on the following terms as conditions:

1. **COMMODITY** : _____
2. **SPECIFICATIONS** : _____
3. **COUNTRY OF ORIGIN** : _____
4. **QUANTITY** : _____
5. **UNIT PRICE** : _____
6. **TOTAL VALUE** : _____
7. **PACKING** : _____
8. **TERMS OF PURCHASE** : Free delivery at BUYER Factory situated at Jinnah Avenue, Malir Halt, Karachi.

9. **DELIVERY:**

The SUPPLIER shall deliver the goods within period as provided in Purchase order, to the authorized representative of the Corporation and obtain his signature with name and designation, otherwise the BUYER will not be responsible for the goods delivered. No supply shall be made on holidays & after 4 pm from Monday to Thursday & 1 pm on Friday & Saturday.

10. **LIQUIDATED DAMAGES:**

The SUPPLIER shall pay to the BUYER at the rate of 2% per month or part of month for the value of the stores which the SUPPLIER has failed to deliver within the stipulated period, provided that damages shall not exceed 10% of the total price payable under the Purchase Contract, otherwise BUYER will make deduction from SUPPLIER'S bill.

11. **FORCE MAJEURE**

The SUPPLIER shall not be held responsible for late or non-delivery of the goods due to strikes and generally recognized force majeure causes. However, in such cases, the SUPPLIER shall deliver to the BUYER a certificate of the accident issued by the competent Government Authority and/or the Chamber of Commerce at the place where the accident occurred as evidence thereof, reasonable extension shall be granted at the option of the Corporation.

12. **INSPECTION**

The BUYER or his authorized representative shall have the right to inspect any goods after or before the dispatch from the SUPPLIER'S Factory or premises. However, such inspection shall not absolve the SUPPLIER from the responsibility or liability for the delivery of goods according to the contracted specification nor shall be interpreted so as in any way to imply acceptance of such goods.

13. **WARRANTY**

The SUPPLIER hereby gives a warranty that the supplies to be made by him will be highest grade in quality consistent with the established and generally accepted standards. The SUPPLIER Shall protect and indemnify the BUYER against loss, damages and expenses whatever that the BUYER may suffer as a result of failure of the material to render useful service and that this warranty to remain effective after inspection and payment, as to the patent or latent defect detected after installation or use for a period of _____.



14. CLAIM.

If the SUPPLIER fails to deliver the goods within the period stipulated in the contract, or if the goods are short in weight, or if the packing of the goods is not in conformity with the contracted specification or reference samples, or if the goods otherwise not in accordance with the contracted specifications, the BUYER shall have the right in addition to and not withstanding their right to claim compensation for breach of contract, to terminate the un-executed part of the contract and make purchases from other sources at the risk and cost of the SUPPLIER. The supplier shall settle all claims referred by the BUYER within fifteen days of the receipt of the same and in the event of their failure to do so, shall be liable to pay interest @ 14% per annum of the amount claimed

15. PERFORMANCE GUARANTEE.

05% Performance Guarantee is required of the total contract amount (excluding taxes) for the period exceeding 28 days of contract period. The Performance Guarantee shall be in the form of an unconditional Bank Guarantee or insurance guarantee (PACRA Rating AAA & AA++ only) enforceable in Pakistan as per Performance Guarantee form specified in the Bidding Documents. Otherwise, Bid Security submitted with the tender document will be considered as part of performance guarantee and remaining amount will be deducted from the first bill of the supplier.

This amount will be refunded to the SUPPLIER, after 30 days successful performance of the contract by them. The period of 30 days will be counted from the date of delivery of the goods in full. The guarantee furnish by the SUPPLIER shall only be in the nature of security for performance of the contract and the BUYER shall not be precluded from claiming any amount in excess of the sum mentioned in the guarantee by way of damages for the breach of contract.

16. OTHER CONDITIONS:

- A) The SUPPLIER shall arrange delivery of goods with advance Note or Delivery Challan on which the Purchase Order No. quantity and supplier's name must be mentioned. Otherwise, it shall be liable to non-acceptance and held by the BUYER at the SUPPLIER risk and if not cleared by them within a week time, godown expenses shall be charged at actual.
- B) The SUPPLIER shall not transfer or assign directly to any person or person any portion of this contract without prior written consent of the Buyer.

17. PAYMENT.

Advance or part payment, if any, as per terms & conditions of Purchase Order/ BOQ. Payment/ part payment shall be made by the BUYER through cheque within 30 days (95% in case of non-submission of Performance Guarantee) of receipt of two copies of the invoice/ bill by the General Manager (Finance & Accounts) of the Corporation and one copy of the Purchase Order along with copy of relevant advice note or challan and acceptance certificate from the BUYER authorized Officer/ Stock Controller.

18. TAXES & CHARGES.

Supplier shall pay all taxes & charges with respect to transaction of business under this contract agreement liable under any law enforce for the time being which may subsequently enforce during the execution of this agreement.

19. ARBITRATION

In case of any dispute and difference which may arise in connection with the execution of the contract, shall be referred to Managing Director of Corporation. The decision of whom shall be binding on both the parties.

In case the dispute remains unresolved, the matter will be resolved through arbitration as per the Arbitration Act, 1940.

20. TERMINATION

The purchaser, without prejudice to any other remedy for breach of contract, by written notice of default sent to the supplier, may terminate this contract in whole or in part:



- A- If the supplier fails to deliver any or all of the goods within the period(s) specified in the contract, or within any extension thereof.
- B- If the supplier fails to perform any other obligations(s) under the contract.
- C- If the supplier, in the judgment of purchaser, has engaged in corrupt or fraudulent practices in competing for or in executing the contract. In the event the purchaser terminates the contract in whole or in part, the purchaser may procure, upon such terms and in such manner as it deems appropriate, goods & services similar to those undelivered, and the supplier shall be liable to the purchaser for any excess costs for such similar goods or services. However, the supplier shall continue performance of the contract to the extent not terminated.

21. CLOSURE OF CONTRACT

After completion of satisfactory delivery of awarded item and payment to supplier, this contract shall be considered as closed.

IN WITNESS WHEREOF the parties hereto have set their respective hands and seals on the day and year first above mentioned.

For and on behalf of the CORPORATION

For and on behalf of the SUPPLIER

Signature. _____	Signature. _____
Name. _____	Name. _____
PAKISTAN SECURITY PRINTING CORPORATION (PVT.) LIMITED	_____
Jinnah Avenue, Malir Halt, Karachi.	_____
<u>WITNESSES: -</u>	<u>WITNESSES: -</u>
Signature : _____	Signature : _____
Name : _____	Name : _____
Address : _____	Address : _____

N.I.C. NO. : _____	N.I.C. NO. : _____



Integrity Pact

DECLARATION OF FEES, COMMISSION AND BROKERAGE ETC. PAYABLE BY THE SUPPLIERS OF GOODS, SERVICES & WORKS IN CONTRACTS WORTH RS.10.00 MILLION OR MORE

Contract Number: _____

Contract Value: _____

Contract Title _____

Date: _____

[Name of Supplier] hereby declares that it has not obtained or induced the procurement of any contract, right, interest, privilege or other obligation or benefit from Government of Pakistan or any administrative subdivision or agency thereof or any other entity owned or controlled by it (GoP) through any corrupt business practice.

Without limiting the generality of the foregoing [Name of Supplier] represents and warrants that it has fully declared the brokerage, commission, fee etc. paid or payable to anyone and not given or agreed to give and shall not give or agree to give to anyone within or outside Pakistan either directly or indirectly through any natural or juridical person, including its affiliate, agent, associate, broker, consultant, director, promoter, shareholder, sponsor or subsidiary, any commission, gratification, bribe, finder's fee or kickback, whether described as consultations fee or otherwise, with the object of obtaining or inducing the procurement of a contract, right, interest, privilege or other obligation or benefit in whatsoever form from GoP, except that which has been expressly declared pursuant hereto.

[Name of Supplier] certifies that it has made and will make full disclosure of all agreements and arrangements with all persons in respect of or related to the transaction with GoP and has not taken any action or will not take any action to circumvent the above declaration, representative or warranty.

[Name of Supplier] accepts full responsibility and strict liability for making and false declaration, not making full disclosure, misrepresenting fact or taking any action likely to defeat the purpose of this declaration, representation and warranty. It agrees that any contract, right interest, privilege or other obligation or benefit obtained or procured as aforesaid shall, without prejudice to any other right and remedies available to GoP under any law, contract or other instrument, be voidable at the option of GoP.

Notwithstanding any rights and remedies exercised by GoP in this regard, [Name of Supplier] agrees to indemnify GoP for any loss or damage incurred by it on account of its corrupt business practices and further pay compensation to GoP in an amount equivalent to ten time the sum of any commission, gratification, bribe, finder's fee or kickback given by [Name of Supplier] as aforesaid for the purpose of obtaining or inducing the procurement of any contract, right, interest, privilege or other obligation or benefit in whatsoever form from GoP.

[Buyer]

[Seller/Supplier]



Performance Security (or guarantee) Form

To: **Pakistan Security Printing Corporation (Pvt.) Ltd**

WHEREAS *[name of Supplier]* (hereinafter called "the Supplier") has undertaken, in pursuance of Contract No. *[reference number of the contract]* dated *[insert date]* to delivery *[description of goods and services]* (hereinafter called "the Contract").

AND WHEREAS it has been stipulated by you in the said Contract that the Supplier shall furnish you with a Bank Guarantee by a reputable bank for the sum specified therein as security for compliance with the Supplier's performance obligations in accordance with the Contract.

AND WHEREAS we have agreed to give the Supplier a guarantee:

THEREFORE, WE hereby affirm that we are Guarantors and responsible to you, on behalf of the Supplier, up to a total of *[amount of the guarantee in words and figures]*, and we undertake to pay you, upon your first written demand declaring the Supplier to be in default under the Contract and without cavil or argument, any sum or sums within the limits of *[amount of guarantee]* as aforesaid, without your needing to prove or to show grounds or reasons for your demand or the sum specified therein.

This guarantee is valid until the: *[insert date]*

Signature and seal of the Guarantors

[name of bank or financial institution]

[address]

[date]



PAKISTAN SECURITY PRINTING CORPORATION (PVT.) LIMITED

CODE OF CONDUCT

Objective

This Code of Conduct aims to establish PSPC's business and employment practices on the highest standards of ethical behavior, integrity, accountability, courage and excellence.

It also aims to ensure that all concerned adhere to PSPC's defined core values, act with prudence, protect the interests of PSPC and maintain a positive work environment.

Scope

This Code of Conduct is applicable on all PSPC Employees, Contract Employees, Trainees, Apprentices, Deputationist, Outsourced Workforce, and other stakeholders.

General Behavior

The ethical principles of the Corporation prevail over the concerned individual's personal origins, beliefs, values, opinions, preferences, or habits at all times. All concerned, while they are in PSPC's service, shall strictly adhere to the following rules of General Behavior at all times which include, but are not limited to, the following responsibilities:

3.1. Comply with all applicable laws, including, but not limited to, those pertaining to general employment, anti-fraud, corruption, bribery, anti-discrimination, anti-harassment, health, safety and environmental protection.

3.2. Conduct themselves honestly and carry out their duties diligently and impartially to the best of their abilities, in compliance with the applicable rules, regulations, policies and procedures, as defined by PSPC from time to time.

3.3. Maintain highest standards of ethics and professionalism and devote their working activities to the service of PSPC.

3.4. Not guarantee or promise employment of any type to anyone for any length of time.

3.5. Assist and advise colleagues and show openness and transparency in all dealings with them.

3.6. Do not withhold information from concerned colleagues that may affect the conduct of business, particularly in order to gain a personal advantage. Providing false, inaccurate or exaggerated information, refusing to cooperate with colleagues or demonstrating any form of obstructive behavior is strictly not allowed.

3.7. Not indulge in any activity during off duty hours that directly or indirectly undermines the provisions of this Code, other PSPC rules, policies and procedures, or brings disrepute to PSPC.

3.8. Refrain from indulging in any illegal and unlawful activity including but not restricted to substance abuse and consumption of alcohol, drugs or any kind of intoxicant(s), as well as, any sort of gambling/betting activities, etc.



3.9. Officers of PSPC performing supervisory functions/roles on behalf of PSPC shall take every possible care to act within the delegated authority as provided by any law, rules or regulations under which such officers may purport to act.

Fraud, Embezzlement & Misrepresentation

4.1. All concerned shall not commit, or assist any activity that involves making false statements, fraud, forgery, misappropriation, theft, embezzlement, bribery, misrepresentation, violation of PSPC rules and regulations, policies and procedures or any similar activity that harms, or may harm the interest and reputation of PSPC.

4.2. Be honest in conveying professional conclusions, opinions, research and findings for whatever purpose and shall not manipulate the system for personal gains.

4.3. Refrain from indulging in any illegal and unlawful activity.

4.4. Abstain from any false or intentionally misleading information and declarations, bogus documents, and submit false or misleading claims with wrong information.

Discrimination and Harassment

5.1. All concerned shall treat all internal and external stakeholders with respect, fairness and courtesy and avoid all such forms of behavior that create or may create an atmosphere of harassment, hostility, intimidation and discrimination of any kind, especially involving age, gender, health, ancestry, physical disability, race, religion, length of service, political beliefs, marital status or family structure.

5.2. Shall not propagate in any manner whatsoever sectarianism, ethnic / regional hatred / animosity and take part in sectarian, ethnic, linguistic or parochial activities, as well as partiality or favoritism on these bases, indulge in nepotism, victimization, willful abuse of power, and unwarranted negative criticism and gossip about other employees.

5.3. Avoid creating / sending / forwarding electronic or any other form of communication that contains statements or material, which is discriminatory, offensive, defamatory, illegal or constituting harassment.

5.4. Refrain from engaging in any form of inappropriate relationship with persons with whom they have a professional relationship.

Confidentiality

6.1. All concerned shall maintain strict confidentiality of PSPC and its constituents affairs and shall not communicate directly or indirectly to their colleague(s) or (ex) employee(s) belonging to other department(s) or profession or to the press or public, any document or information which has come into their possession in the course of their official duties, or has been prepared or collected by them in the course of their duties, whether from official sources or otherwise, unless compelled to do so by judicial or other authority or unless instructed to do so by a superior officer in the discharge of his / her duties.

This confidentiality must be maintained by the employee even after the cessation of their employment with PSPC.

6.2. All concerned shall not give any evidence, document, or any information before a public committee without the prior approval of the Competent Authority.

6.3. Interaction or communication directly or indirectly on behalf of PSPC with foreign governments, media, and missions in Pakistan without seeking clearance from the competent authority is not permissible.



Use of PSPC Assets and Resources

7.1. All concerned are required to use PSPC assets such as properties, office equipment, supplies etc. for PSPC's business purposes and not for gain or benefit of persons or entities other than PSPC, including self.

7.2. Material information such as information contained in any file, document, note, report, letter, fax, USB, email, instrument, etc. held by the concerned must be used solely for the purpose of PSPC business and returned to PSPC upon cessation of employment / contract agreement.

7.3. Official information, documents, reports, proposals, research papers, software, etc. developed using PSPC time and resources constitute PSPC's intellectual property. All concerned will neither have the right to claim these as their own, nor shall they use/exploit the same for personal gain or benefit of persons or entities other than PSPC during or beyond cessation of their employment with PSPC.

Political Affiliation

8.1. No employee of PSPC shall take part in or subscribe in aid of or assist in any way, any political activity / movement in Pakistan or relating to the affairs of Pakistan, or take part in, or in any way assist, any movement or activity, which is, or tends directly or indirectly to be, subversive to Government as by law established in Pakistan or detrimental to the ideology or integrity of Pakistan.

8.2. Employees shall not canvass or otherwise interfere with or use their influence in connection with or take part in any election to a legislative body, whether in Pakistan or elsewhere, provided that an employee who is qualified to vote at such election may exercise their right to vote; but if he/she does so, he/she shall give no indication of the manner in which he/she proposes to vote or has voted.

Attendance and Punctuality

9.1. All concerned shall not leave the office or absent himself / herself from duty, without prior permission of the Competent Authority.

9.2. Strictly adhere to defined break timings, as defined by PSPC from time to time.

Conflict of Interest

10.1. All concerned are required to recognize and disclose activities that might give rise to conflicts of interest or the perception of conflicts and to ensure that such conflicts are properly managed or avoided. All disclosure should be made at the time the conflict arises, or when it is recognized that a conflict may be perceived, in writing to the supervisor. If the supervisor also has an interest in the matter, the disclosure shall be made to the next higher level of authority.

10.2. While an officer is serving in PSPC, their spouse, children and siblings will henceforth not be eligible for recruitment in PSPC, SBP and/or any of its other subsidiaries.

Gifts and Entertainment

11.1. Except as permitted, employees shall neither receive nor give any gift(s) or favor(s), in cash or any kind, from / to any organization, including those stakeholders (individual, entities or person created by law) who are in contact with PSPC.

11.2. The above instructions will not be applicable in case;



- a. A gift received for value of up to Rs 10,000 provided aggregate value of gifts received / given from / to during a fiscal year from same source does not exceed Rs 20,000;
 - b. Advertising materials including trade discounts that an individual or entity normally offers to its general customers;
- 11.3. The intended recipient will politely refuse the offer of gifts valuing above. However, where such refusal may impact the official relationships, the gift so received would be immediately, but not later than 72 hours, surrendered to HR.

Prohibitions

12.1. Smoking or other use of tobacco products (including, but not limited to, cigarettes, pipes, cigars, electronic Cig, snuff, or chewing tobacco) is not permitted within the office premises. Employees may smoke outside in open air, at the designated areas, without compromising on the working hours.

12.2. Use of any sort of drug including Pan, Gutka, Naswar, etc. within the office premises is not allowed.

Self-Disclosure of Criminal Conviction

All employees are required to self-disclose any criminal offence for which any investigating agency have taken cognizance and for which a conviction has been decided against such an employee by any court of law while being professionally engaged with PSPC irrespective of the nature of engagement.

Health & Safety

All employees must take measures to promote safe working practices, and follow the instructions given by the Health, Safety, and Environment Team from time to time.

Whistleblowing

All concerned are responsible to immediately report any alleged ethical misconduct or fraud. The employees may raise their concerns through a written report or email at whistleblower@pspc.gov.pk. For more information on the applicability of this policy, refer to Whistleblowing Policy.

Compliance with the rules of conduct

Role of line managers

16.1.1. Line managers shall take the necessary measures to encourage respect for the rules of conduct within the entities for which they are responsible.

16.1.2. Managers should ensure that employees placed under their authority are aware of this code.

16.1.3. Apart from the vigilance, line managers are expected to behave in an exemplary manner as regards respect for the principles and rules set out in this code.

16.2. Any information pertaining to violation of this Code must immediately be reported to Director Human Resources.

16.3. If Director Human Resources is found to be violating this Code, MD may be reported. In case of violation by MD, Chairman PSPC may be reported.



Reporting Confidentially

17.1. All stakeholders when reporting to Director HR shall be deemed to have made such report in strict confidence.

17.2. Human Resource Department shall not disclose the identity of concerned employee to other parties unless it is in the interest of the Corporation or it is required by law.

Consequences of Violating the Code

18.1. Any employee who violates the Code shall be subject to disciplinary action.

18.2. Failure to report deviations of the Code by all concerned may result in disciplinary action. Similarly, failure to report deviations of the Code by other stakeholders may result in the termination of their relationship with the Corporation.

Interpretation

This policy shall supersede all previous policies on the subject. In case of any ambiguity in understanding this Policy, the interpretation of the Managing Director will be treated as final. Any exception to the policy shall be approved by the Managing Director on the recommendation of Director HR and shall be reported to Board Human Resource Committee for ratification.



Undertaking for Compliance with Code of Conduct

Bidder Name: _____

Bidder Representative (If any): _____

Date: _____

I, the undersigned, on behalf of [Bidder Company Name], hereby acknowledge that I have received, read, and understood the Code of Conduct established by [Procuring Agency Name].

As a bidder participating in the procurement process, I undertake to:

1. Adhere to the highest standards of integrity and professionalism in all interactions with PSPC
2. Ensure that all communications and representations made during the bidding process are truthful and transparent.
3. Comply with all applicable laws, regulations, and policies outlined in the Code of Conduct.
4. Avoid any conflicts of interest and disclose any potential conflicts promptly.
5. Report any unethical behavior or violations of the Code of Conduct to the appropriate authorities within PSPC.

I understand that any breach of this undertaking or the Code of Conduct may result in disqualification from the bidding process and potential legal consequences.

Authorized Signature: _____

Date: _____



Undertaking for Compliance with Health, Safety & Environment (HSE) Policy of PSPC

Bidder Name: _____

Bidder Representative (If any): _____

Date: _____

As a bidder participating in the procurement process, I undertake to comply with all applicable HSE laws, regulations and industry standards; and with all following HSE requirements of PSPC:

1. Suppliers / Contractors are responsible for the health, safety and well-being of their employees. The contractors will also be responsible to provide relevant personal protective equipment (PPEs) to their workforce where required.
2. Suppliers / Contractors who have their own HSE management system, shall provide details of the same on request.
3. The contractor / suppliers must take all necessary safety precautions related to the performance of contract in order to protect all worksites, including all personnel and property of the PSPC, the contractor, all third parties and the communities.
4. Contractor shall ensure that all personnel are adequately trained & skilled to perform the task assigned.
5. Supplier / Contractor shall ensure compliance with PSPC policies, procedures and applicable legal and regulatory requirements after award of contract and during execution. These policies and procedures can be obtained upon request from Purchase Department.
6. Contractor shall adhere to set standards and requirements for environmental protection.

I, the undersigned, on behalf of [Bidder Company Name], hereby acknowledge that I have received, read, and understood the HSE requirements of PSPC.

Authorized Signature: _____

Date: _____



**Undertaking for Non-Participation of Current or Former
PSPC Workforce**

Bidder Name: _____

Bidder Representative (If any): _____

Date: _____

We, **[Name of Bidder / Firm]**, having our registered office at **[Address]**, hereby solemnly affirm and undertake that:

1. I or our representative for this tender is/was not associated with Pakistan Security Printing Corporation (PSPC) as regular employee, contractual or outsourced / third party resource during last 5 years. I further undertake that I will not engage / depute at PSPC any person who remained employed at PSPC on any outsourcing arrangements during last 5 years., We acknowledge and accept that PSPC reserves the absolute right to reject our bid at any stage of the procurement process if this undertaking is found to be false, misleading, or violated in any manner, without any liability or obligation on the part of PSPC.
2. We also acknowledge that no entry approval request shall be submitted for any person mentioned at S. No 1 for any procurement-related activity, including but not limited to bid opening, pre-bid meetings, inspections site visits etc. and we undertake full compliance in this regard.
3. We understand that submission of a false declaration shall render us liable to disqualification, blacklisting, and any other action permissible under applicable laws, rules, and PSPC procurement regulations.
4. This undertaking is submitted with full cognizance of its legal consequences and shall remain in full force and effect throughout the procurement process and, where applicable, any agreement entered into thereunder.

Authorized Signature: _____

Date: _____



Rs. 500/- Stamp Paper Print

P.O.#: _____

NON-DISCLOSURE AGREEMENT (NDA)

This agreement is entered into as of day of Year

between

Pakistan Security Printing Corporation (Pvt.) Limited, Manufacturer of Banknotes and Prize Bonds registered under the laws of Pakistan, having its registered office at Jinnah Avenue Malir Halt, Karachi, through its authorized representative _____ (hereinafter referred to as '**PSPC**', which expression, where the context so requires and permits, shall mean and include its successors-in-interest, administrators, executors, legal representatives and permitted assigns);

and

_____, having its registered office at through its authorized representative (hereinafter referred to as '.....' which expression, where the context so requires and permits, shall mean and include its successors-in-interest, administrators, executors, legal representatives and permitted assigns).

(PSPC and _____ are hereinafter collectively referred to as the "Parties" and individually as a "Party").

'Agreement' means this Agreement and all written amendments and revisions made thereto from time to time.

"Effective Date" means the date of execution of this Agreement.

'State' means the territory of the Islamic Republic of Pakistan.

WHEREAS

The Parties to this Agreement wishes to enter into an Agreement concerning the disclosure of certain proprietary and confidential information, whereby it will be necessary for each party (the "**Disclosing Party**") to disclose to the other Party (the "**Receiving Party**"), as the case may, information of a confidential or proprietary nature for the purposes as defined in the Agreement (**Authorized Purpose**) (irrespective of the form of presentation or communication including, but not limited to data, notes, analyses, compilations, studies, physical objects, samples, financial information, technical information, cost information, techniques, , material, methods, processes, sources and any other information, however, described, which is or could be valuable in the type of business in which Disclosing Party is engaged) provided that any disclosure of information made in writing shall be marked confidential or with words of similar effect and that any disclosure made orally shall subsequently be reduced to writing by the Disclosing Party and marked confidential or with words of similar effect with a copy sent to the Receiving Party within 30 days of disclosure ("Information").



IT IS AGREED AS FOLLOWS:

1. This Agreement will apply to any disclosure of Information on the Effective Date. This Agreement may be terminated by any Party after giving a prior notice of 30 (Thirty) days' in writing; or immediately if the Disclosing Party has reason to believe that the Receiving Party is in breach of any of the obligations contained herein. Such termination shall not affect any obligation imposed by this Agreement with respect to Information received prior to such termination.
2. Receiving Party shall hold and protect the Confidential Information in the same manner as it protects its own confidential information and in any event such protection shall not be less than that which a reasonable person or business would take in protecting its own confidential information; and shall use the Confidential Information for the sole and exclusive benefit of the Disclosing Party. Receiving Party shall carefully restrict access to Confidential Information and only disclose Information on a need-to-know basis to such of its employees, contractors, agents, representatives and consultants as is reasonably required, and are under similar obligations of confidentiality as contained in this Agreement, the use whereof shall be restricted for Authorized Purpose only.

Receiving Party shall not, without the prior written approval of the Disclosing Party, use publish, copy, or otherwise disclose the Confidential Information to others, or permit the use by others for any purpose other than the Authorized Purpose. Receiving Party shall, forthwith upon receipt of a written request from the Disclosing Party or on termination:

- (i) return all information supplied by the Disclosing Party as well as items and materials relating to or derived from the Information;
 - (ii) deliver to the Disclosing Party or at its request destroy immediately all items and materials made by the Receiving Party containing Information, that are not returned pursuant to paragraph (i) above;
 - (iii) not keep copies or duplicates of any items or materials referred to in paragraphs (i) or (ii) above; and
 - (iv) provide a certificate signed by a senior officer of the Receiving Party confirming that the provisions of this clause have been complied with.
3. This Agreement shall not apply to any Information which the Receiving Party: (a) can show is or becomes publicly available through no fault of the Receiving Party; (b) can show was in its possession prior to the date of disclosure; (c) may subsequently receive from any third party legally in possession of the Information and who was not restricted from disclosing it; (d) can show is independently acquired by the Receiving Party as a result of work carried out by an employee, consultant or contractor of the Receiving Party to whom no disclosure of Information has been made; or (e) is required to disclose pursuant to a court order or any law/rules/regulations provided that the Receiving Party shall have given prior written notice to the Disclosing Party.
4. This Agreement shall not be deemed to confer or imply the grant or agreement to grant by the Disclosing Party to the Receiving Parties of any of its rights under copyright, patents, trademarks, design rights or other similar rights. All Information supplied hereunder is supplied on an "as is" basis and the Disclosing Party gives no representation or warranty as to its accuracy, completeness or fitness for any purpose other than the Authorized Purpose. The Disclosing Party shall not be liable for any loss or damage suffered by the Receiving Parties as a result of any Receiving Party's use of the Information.
5. This Agreement does not create any agency or partnership relationship and each party shall act as an independent entity. This Agreement will not be assignable or transferable



by the Parties. All additions or modifications to this Agreement must be made in writing and signed by the Parties.

6. Notices shall be delivered personally, or by prepaid first class mail, or transmitted by facsimile to the Parties at such address or number as the parties shall specify from time to time.
7. The Receiving party may obtain consent of the Disclosing party for any waiver of rights, to share information received under this Agreement to a third party for the Authorized Purpose. Any waiver of any right under this Agreement is only effective if it is in writing and applies to the specific circumstance for which it has been given.
8. In the event of a breach, Disclosing Party shall be entitled, in addition to any other remedies and damages available at law or in equity, to an injunction to restrain the violation thereof by Receiving Party, or its employees, contractors, agents, representatives and consultants,
9. This Agreement shall be governed by and shall be construed in accordance with the laws of Pakistan. In case a dispute arises between the Parties with regard to the terms of or rights and obligations of the Parties under this Agreement, if not resolved amicably, shall be referred to the arbitrator to be mutually appointed by the Parties. The arbitration shall be carried out in accordance with the Arbitration Act, 1940 in English. The award shall be conclusive, and binding on the Parties and the Parties submit to the non-exclusive jurisdiction of the Pakistan's Courts.

In WITNESS WHEREOF, the parties have executed this Agreement and shall be effective as of the date first above written.

For and on behalf of
of
Pakistan Security Printing Corporation

For and on behalf

This Agreement has been executed in the presence of the following witnesses:

1. Full Name: _____
Address: _____
Signature: _____
CNIC No: _____
2. Full Name: _____
Address: _____
Signature: _____
CNIC No: _____

