

**BID / TENDER DOCUMENT**  
**TENDER NO. GC/34/TRE/25-26**

**INVITATION OF QUOTATION FOR FABRICATION & SUPPLY OF T.R. UNIT**  
**ENCLOSURES OF CP STATIONS IN GUJRANWALA REGION**

Sui Northern Gas Pipelines Limited (SNGPL), herein after referred as the Company, intends to award contract for the financial year 2025-26 for fabrication and supply of T/R unit enclosures of CP Stations in Gujranwala Region.

Technically sound Contractors who are registered with Income Tax and Sales Tax Departments and who are on Active Taxpayers List of the Federal Board of Revenue and are professional tax payers, are eligible to submit their sealed quotations for the following work, keeping in view all the terms and conditions given here under.

**Scope of Work**

The Scope of Work for the above-mentioned job includes fabrication & supply of T/R unit enclosures in accordance with the terms and conditions given below. A detailed drawing containing design and dimensions of the enclosure and its roof is attached. The specifications of the materials to be used are also given in the drawing. The contractors are required to quote lump sum price (including all applicable taxes) per completed T/R enclosure (including fabrication charges, material cost, shifting charges, loading / unloading charges and any other charges) in accordance with the terms and conditions.

**Terms and Conditions**

- a) The Company reserves the right to reject any or all of the quotations without assigning any reason.
- b) The Company reserves the right to cancel the award of contract at any stage if it is found that the performance or progress of the contractor is not satisfactory and the jobs are likely to be delayed or adversely affected. In such an event, the Company reserves the right to award the contract to any other contractor.
- c) The contractor / bidder will submit the original tender document provided by the Company, after signing and affixing his stamp on each page, as a token of understanding and acceptance of the terms and conditions of the tender document.
- d) The bidders are required to submit on copy each of valid Income Tax Certificate, GST Certificate, PRA Certificate and latest Professional Tax Certificate along with their bid offer.
- e) The bidder must ensure to mention his name and designation on the bid offer. All the future correspondence (letters / invoices etc.) with the Company shall be accepted only if it is initiated and signed by the same signatory.
- f) The rates quoted by the contractor shall be for complete finished work and shall be comprehensive and complete in all aspects including fabrication charges, material cost, shifting charges and loading / unloading charges and any other arrangements / jobs which are necessary for completion of the work.
- g) The contractor shall obtain prior approval for type, design and specifications of the materials to be used and will submit specimens / samples of all the approved materials before start of work, otherwise if any loss occurs due to rejection of un-approved material by the Company, the contractor will be solely responsible for it.

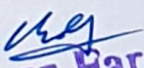
  
**Umer Farooq**  
Executive Engineer (Corrosion)  
SNGPL - Gujranwala



- h) No advance payment shall be made.

The rates quoted will remain valid for the whole fiscal year **2025-26** and no escalation charges in aspect of any kind of material or services shall be paid in any case due to increase of prices of any material in the market or due to increase in the rate of any applicable Tax. The rates quoted for the whole fiscal year i.e. **2025-26** may remain valid in case of extension of work for 03 months after mutual agreement of two parties i.e. SNGPL and the Contractor for current year jobs delayed beyond reasonable control.

- i) All government taxes (GST, PRA, Income Tax or any other tax) whichever will be applicable on this work / contract shall be borne by the contractor. If any amendment in the rate of any of the applicable taxes is notified by the government during the fiscal year **2025-26**, the contractor shall have to bear the increase in the cost. Therefore, the rate quoted by the bidder shall be considered to be inclusive of all applicable taxes.

- j) No amendment or modification in the scope of work / terms and conditions of the Tender Document shall be made except those conveyed by the Company in writing.

- k) The contractor shall be required to comply with the HSE policy of the Company. The contractor will submit duly signed and stamped "Contractor's HSE Statement" (attached as Annexure-A) along with his bid offer. During work at the Company's site, the Contractor will be bound to comply with all those HSE regulations of the Company that are applicable on all the contractors working with the Company.

- l) The contractor shall be liable to pay compensation to his staff / labor in case of any major injury, disability and fatality category wise as under:

1. In case of Major Injury (Injury leading to Temporary disablement)	Payment of ½ of the monthly wages till the recovery of temporary disablement or for a maximum period of one year, whichever is less.
	Payment of 1/3 of the monthly wages till the recovery of chronic ill health / disease or for a maximum period of 5 year, whichever is less.
2. In case of Disability (Permanent)	Rs. 500,000/-
3. Fatality	Rs. 500,000/-

- m) Failure to compliance against HSE initiative at operational sites will lead to blacklisting of a contractor through following disciplinary actions.

I. 1 <sup>st</sup> Violation	Warning letter
II. 2 <sup>nd</sup> Violation	Deduction of Rs. 100,000/- (Rupees One Lac only)
III. 3 <sup>rd</sup> Violation	Deduction of Rs. 500,000/- (Rupees Five Lac only)
IV. 4 <sup>th</sup> Violation	Suspension for a period of six months.
V. 5 <sup>th</sup> Violation	Black Listing

- n) The Contractor shall be bound to respond and supply the finished enclosures within ten days of intimation to him. In case of non-compliance, an amount equal to 10% of the total amount will be deducted as penalty from the bill.



**Umer Farooq**  
Executive Engineer (Corrosion)  
SNGPL - Gujranwala



- o) The contractor shall be required to supply the finished enclosures at the site as advised by the Company. Safe loading / unloading of enclosure using proper measures / equipment at site shall also be the responsibility of the contractor.
  - p) Roof of the enclosure should be jointed / fixed with the structure of the enclosure in such a way that it is able to bear wind pressure during storms and is not broken / detached from its base. In this regard the design / method of fixing shall used after approval of the Company.
  - q) The Company reserves the right to reject any / all of the completed / finished TR enclosures at the time of delivery if it is found that the design or the materials used are not in accordance with the specifications given by the Company in the tender / bid document.
  - r) The contractor shall be required to deliver the completed TR unit enclosures at the CP station sites within the domain of SNGPL Gujranwala Region and as such the transportation cost should be included in the total lump sum quoted cost of the TR unit enclosure.
  - s) SNGPL reserves the right of inspection of workshop / facilities of the contractor before awarding contract. The Company reserves the right to cancel award of contract if any discrepancies are observed in the quality of the materials / workmanship.
  - t) The bidders shall be required to submit a bid bond along with their bids / quotations for an amount of **Rs. 50,000/-** in the form of pay order / demand draft / banker's Cheque / CDR from a scheduled bank. Any bid received without bid bond will be rejected. The bid bonds will be returned to all un-successful bidders in due course of time after necessary processing.
  - u) The successful bidder shall furnish a Performance Bond in the shape of Bank Guarantee / demand draft / pay order / banker's Cheque from any scheduled bank of Pakistan equal to ten percent (10%) of the contract sum. The Performance bond shall remain valid from the date of issuance of contract until three (03) months after the date of completion of the contract. The cost incurred on processing / preparation of performance Bond shall be borne by the successful bidder in all aspects.
  - v) The amount of bid bond and performance bond shall be calculated on the basis of tentative / estimated volume of work that is expected to be carried out during the fiscal year. However due to any reason, the actual volume of work may exceed or may be less than this estimated volume of work. In such a case, the bidder / contractor shall have no right whatsoever to lodge any claim at any forum against the Company.
  - w) The performance bond will be released three months after successful completion / supply of all required TR Unit Enclosures, on the request of the contractor.
  - x) Failure or neglecting to deliver / provide performance Bond as specified above, shall be considered as abandoning of the contract by the bidder. In this case the bid bond shall not be returned to the contractor and will be liable to be encashed / deposited in the Company's account.
- The performance Bond shall be furnished in accordance with the conditions of the tender document before execution of the contract.
- z) The award of contract shall be applicable for the whole area in the domain of SNGPL Gujranwala Region and completed TR Unit enclosures may be required to be delivered at any of the SNGPL site situated in major cities & towns of the following districts;

*Umer Farooq*

**Umer Farooq**  
Executive Engineer (Corry)  
SNGPL - Gujranwala



Gujranwala , Hafizabad & Wazirabad

Any clarification / information regarding this job / contract may be obtained from the office of the undersigned during office hours on any working day.

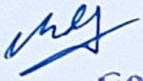
  
**Umer Farooq**  
Executive Engineer (Corrosion)  
SNGPL - Gujranwala



DRAWING OF TR UNIT ENCLOSURE/HUT OF CP STATIONS  
CORROSION CONTROL – GUJRANWALA  
FISCAL YEAR 2025-26

*Umer*  
**Umer Farooq**  
Executive Engineer (Corrosion)  
SNGPL - Gujranwala

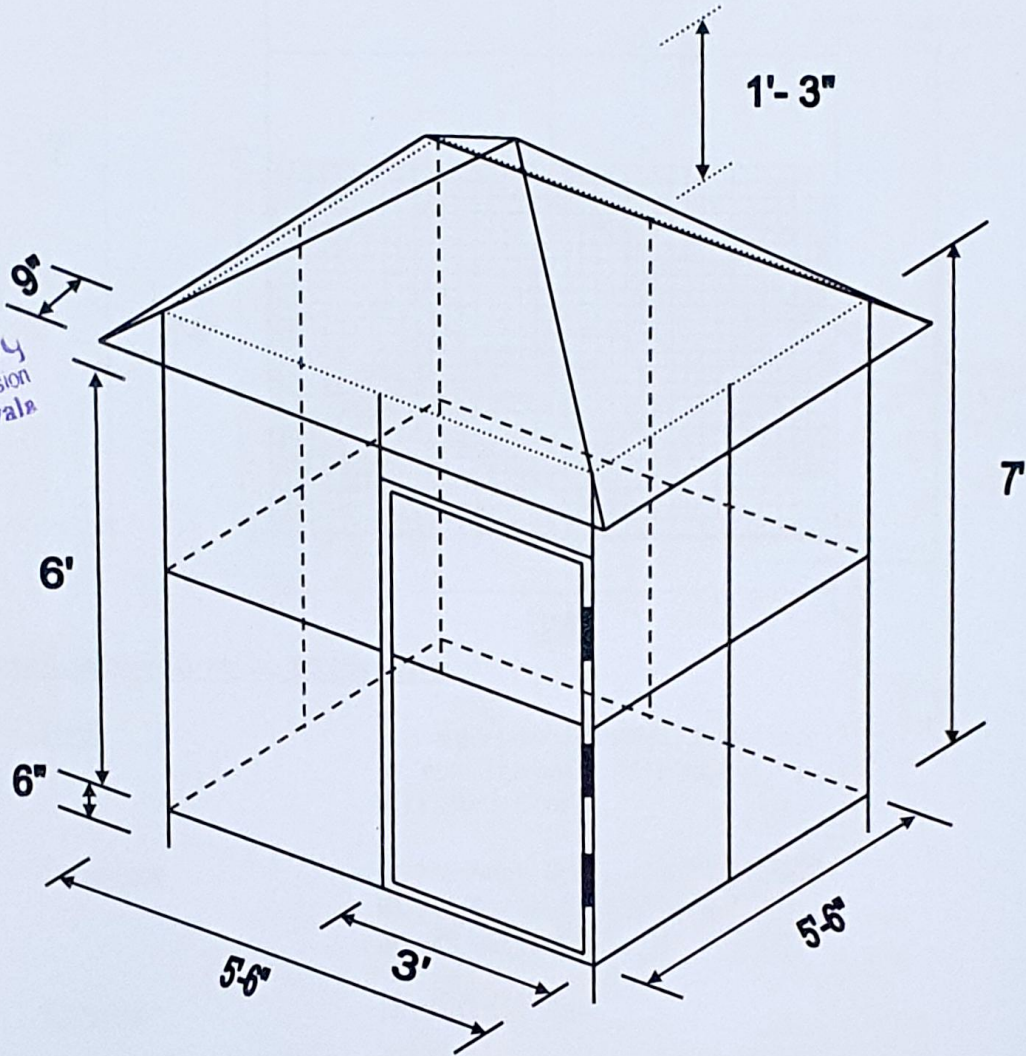

**Detail Drawing of Side of Fencing:**

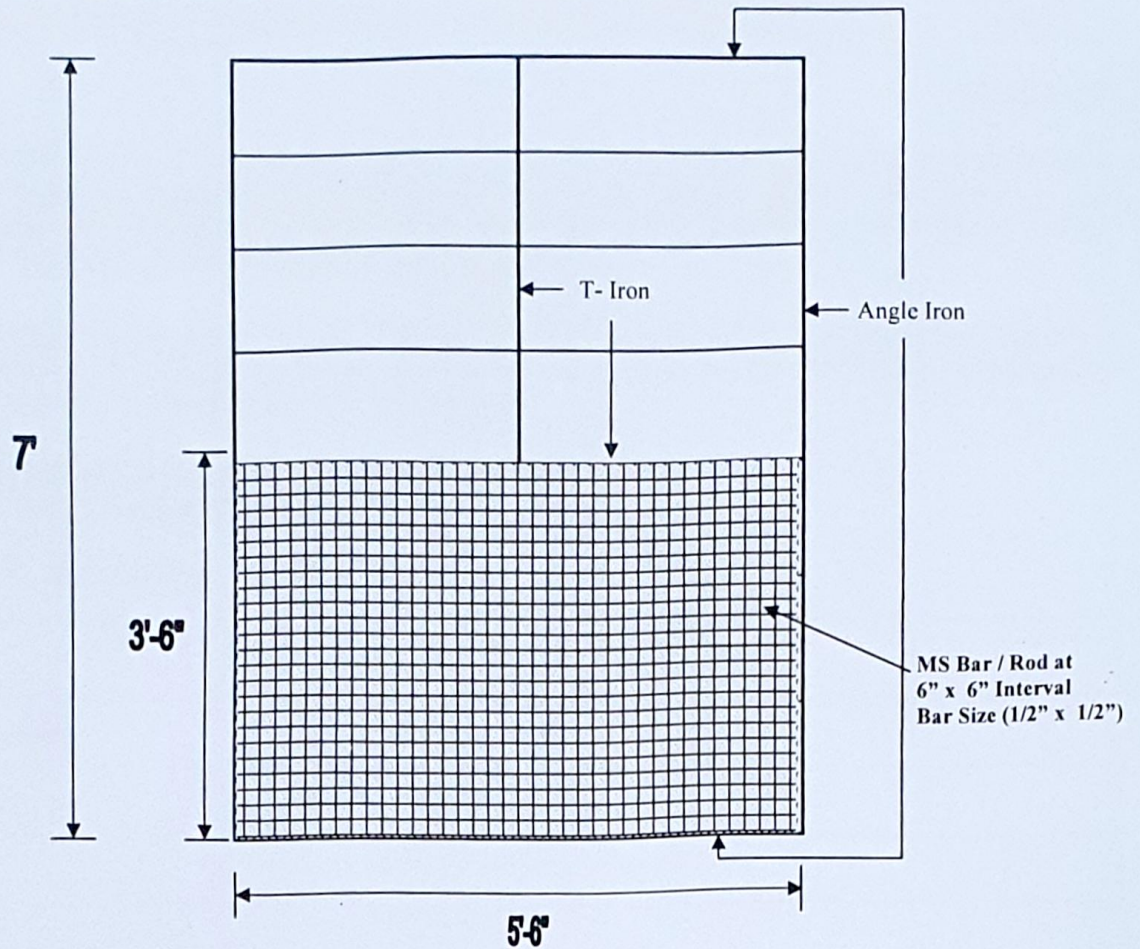

**Description/Specifications Of Materials**

1. **Roof**
  - i) Single piece Moulded Glass Fiber
  - ii) Wall Thickness = 1/8 inch
  - iii) Color = Blue
2. **Structure**
  - i) MS Angle Iron  $1\frac{1}{2}'' \times 1\frac{1}{2}'' \times \frac{3}{16}''$
  - ii) MS T Iron  $2'' \times 1\frac{1}{2}'' \times \frac{3}{16}''$
  - iii) MS Bar/Rod  $\frac{3}{8}'' \times \frac{3}{8}''$
3. **Fencing** 18 SWG MS Sheet
4. **Paint on Metallic Portion** Double coat good quality Enamel (Blue Color)
5. **Lock** Good quality stainless steel shutter lock with double lever

  
**Umer Farooq**  
**Executive Engineer (Corr. Control)**  
**Gujranwala**



	<b>SUI NORTHERN GAS PIPELINES LIMITED</b>	<b>DOC. # SNGPL-GPR013-F001</b>	
		Issue # 02	Issue Date
Contractor / Supplier / Vendor HSE Statement		Page 1 of 5	04-02-21

**Annexure-B**

The Contractor/Supplier/Vendor shall prepare and maintain information including a clear method statement, regarding Contractor/sub-contractor activities, which outline the work to be undertaken and the method(s) for minimizing and maintaining environmental impacts, OH&S Hazards and maintaining compliance with HSE regulations.

To assist in organizing and maintaining information, background information sections have been included (section I, II, III). Sections can be modified or deleted as required when requesting a method statement from Contractors / subcontractors.

**SNGPL's Personnel to Complete Sections I, II, and III**  
**Suppliers to Complete Sections IV, V, and VI**

**Section I Your Information:**      [type or print]

<b>Name:</b>	
<b>Phone Number:</b>	
<b>Fax Number:</b>	
<b>Dept Name:</b>	

**Section II. Requisition Information:** [type or print]

<b>Requisition Number:</b>	
<b>Project Number: (if applicable)</b>	

**Section III. Service or Activity to be Performed:** [Check all that apply]

<b><u>Material/Chemical:</u></b> (Production/Non-production)	Paint Solvent Sealer	Treatment Chemicals Lubricants, Oils, Greases Gasoline	Janitorial Material Other (specify) _____ Other (specify) _____
<b><u>Facilities/Construction:</u></b>	Ditching Electrical Paint Structural	Roofing Mechanical HVAC	General Contractor Arch/Engin/Consulting Other (specify) _____
<b><u>Services:</u></b> (Includes Environmental Services)	Janitorial Security Maintenance	Emergency Response Env. Consulting Paint Booth Cleaning	Waste Management Other (specify) _____
<b><u>Containerization:</u></b>	5 gal. Or less Drums Bulk Tanks	<b><u>Type of Contract:</u></b>	Commodity Management On-site Manager Provided Total Cost Contract



**Section IV. Supplier/Contractor/Vendor Information: [Circle / Check all that apply]**

Current Supplier/Contractor/Vendor to this Facility

New Supplier/Contractor/Vendor to this Facility

Currently involved in other Facility project(s)

List Project(s): \_\_\_\_\_

**(Complete Information in table below) [Type or print]**

Name:	
Address:	
City & Province:	
Phone Number:	
Fax Number:	
President/General Manager/ CEO etc:	
Facility Site Coordinator:	
Email Address:	
Phone Number:	
Mobile Number:	
Fax Number:	
Pager:	
24 Hour Emergency Number:	



**Subcontractor Information: (List suppliers/contractors/vendors not identified) [type or print]**

Type	Firm Name
Architectural	
Mechanical	
Electrical	
Heavy Vehicles	
Industrial Services	
Painting	
Roofing	
Architectural/Engineering / Consulting Firm	
Sampling/Testing	
Chemical Supplier	
<u>Other (specify)</u>	
Scrap/Salvage Dealer	
Waste Disposal	
Demolition Disposal	

Note: It is strongly recommended that you have your subcontractors and suppliers involved at this facility should complete a separate HSE briefing package for the facility's review.

	<b>SUI NORTHERN GAS PIPELINES LIMITED</b>	<b>DOC. # SNGPL-GPR013-F001</b>	
		Issue # 02	Issue Date
Contractor / Supplier / Vendor HSE Statement		Page 4 of 5	04-02-21

### **Section V. Contractor / Supplier / Vendor Method Statement:**

Supplier / Contractor / Vendor is financially responsible for on-site HSE remediation actions resulting from incidents involving their employees and subcontractors. To minimize the risk of environmental accidents, please review and initial the items contained in the HSE Management Basics Table below:

<b>Health, Safety and Environment Management Basics</b>	<b>Tick (√)</b>
1. Contractor will ensure that the <ul style="list-style-type: none"> <li>• Health of its employees is protected.</li> <li>• All activities carried out for the execution of the job are safe.</li> <li>• Compliance is met with all relevant laws and regulations.</li> <li>• All HSE (Health, Safety and Environment) procedures of the Company are implemented.</li> <li>• Safe working environment is provided to its employees.</li> </ul>	
2. Contractor will take all necessary steps to minimize the hazards associated with the job. Appropriate personal protective equipment should be provided to the employees where hazards exist.	✓
3. All incidents resulting in Dangerous Occurrence, minor or major injury, fire, vehicle accident and environmental incident are to be reported to Company within 24 hours.	
4. The contractor is to make his own arrangements for treating injuries to his employees. In the event a contractor employee is injured while working for the Company, it is the contractor's responsibility to notify the Company representative immediately and to report the circumstances of injury.	
5. Contractor's mobile equipment such as trucks, crane, welding machines etc must be maintained in good working condition. Contractor's trucks and other mobile equipment should be operated in such a way that material they are carrying does not fall off the equipment on to the roads. If repairs are required or vehicles become immobilized, arrangements must be made to correct the situation with additional outside help.	
6. Prior to the start of work a certificates from a competent authority is to be given to the site in charge by the contractor stating that all mobile heavy equipment are in good working condition.  Only licensed and designated qualified people shall operate contractor's equipment.	
7. Company equipment must not be handled or tampered with by contractor. The Company representative may grant permission to the contractor on specific conditions to operate Company equipment if emergency conditions so require.	
8. When doing work involving excavation, contractors must not damage or break into or otherwise open any underground piping. Extreme care must be exercised in this respect while excavating with power driven equipment. If lines are accidentally damaged, notify the Company representative immediately.	
9. All excavation made by contractors must be fenced, barricaded or otherwise protected so as to prevent personnel from slipping or falling into them.	
10. Drawing / Excavation Include safety talk notified for facilitating contract employees ever during transportation by Cos TPT.	
11. The authorized Company executive will issue a permit appropriate for any work to be done by the contractor at Company's designated sites where work permit procedure is applicable. After receiving permit for work the contractor shall be guided by Company rules and applicable laws in performing his work.	
12. Contractors shall provide to all their staff the relevant PPE's as specified by the Company against each job. Contractors staff will do compliance.	
13. Contractor's job sites must be kept reasonably clean and free of rubbish and debris which may create tripping or fire hazard. Upon completion, the contractor shall leave the area in a clean and orderly manner, removing all contractor's debris, equipment, and excess material.	
14. Contractor shall dispose off all the waste generated from its activity in environment friendly manner as described in Pakistan Environmental Protection Act, 1997.	
15. The Contractor / Vendor / Supplier shall provide information regarding OH&S and environmental conditions pertaining to machinery / equipment / product / material / item being procured or services being hired.	

	<b>SUI NORTHERN GAS PIPELINES LIMITED</b>	<b>DOC. # SNGPL-GPR013-F001</b>	
		<b>Issue # 02</b>	<b>Issue Date</b>
<b>Contractor / Supplier / Vendor HSE Statement</b>		<b>Page 5 of 5</b>	<b>04-02-21</b>

**Section VI. Supplier/Contractor/Vendor Certification: [review and sign]**

I have reviewed and understand the information contained in this document. I also understand that SNGPL's HSE Personnel have the right to inspect our activities and those of our Suppliers/Contractors/Vendors with regards to our on-site activities. I further understand that activities pertaining to service and/or maintenance contracts may only require submission of this form on an annual basis.

<b>Name</b>	
<b>Title</b>	
<b>Signature</b>	
<b>Date</b>	