

Tender Covering Form
Directorate of Procurement (Navy)
Through Bahria Gate

Contact: For General Queries 051-9262306, Bahria Gate 0331-5540649,
Email: adpn33@paknavy.gov.pk

P-33/FOR Section (Contact: 051-9262314)

Tender No and Date R2605/330670

Tender Description Stitching of Dress No. 1 & 2 for Leading and Below

IT Opening Date 11/06/2026

Firm Name _____

Postal Address _____

Email Address for Correspondence _____

Contact Person _____

Contact Number (Landline _____) (Mobile _____)

Document to be Attached with Quotation

Firm is to submit its proposal in a sealed envelope which shall contain 03 x Sealed Envelops as per details given below:

Sealed Envelop 1 – Technical Offer in Duplicate			
This envelope must contain 02 x sets of Technical Offer (01 x Original + 01 x Copy). Each Set must contain following documents as per this order and Supplier is to mark tick against each to ensure that these documents have been			
S No	Document	Original Set	Copy Set
1	Bank Challan of Rs. 200/- for DGDP registered firms and Rs. 300/- for all other firms (in favour of CMA(DP))		
2	DP-1 Form of IT with tick mark against each clause and initiated on each page		
3	DP-2 Form of IT with compliance remarks against each clause and initiated on each page		
4	Annex A of IT duly filled (with compliance remarks)		
5	Annex B & C of IT (with compliance remarks)		
6	DP-3 Form of IT (duly filled & Signed)		
7	Manufacturer Authorization letter (where applicable)		
8	Manufacturer Price list (where applicable)		
9	DRAP registration letter (in case of medical)		
10	DGDP Registration Letter (If firm is registered with DGDP)		
11	Tax Filling Proof		
Sealed Envelop 2 – Earnest Money			
This Envelop must contain Earnest Money only.			
Sealed Envelop 3 – Commercial Offer			
This Envelop must contain following documents:			
1	Firms Commercial Offer	01 x Original	
2	Principal Invoice (where applicable)	01 x Original	
3	Duly filled DP-2 Form of IT	01 x Original	

Firms Declaration

It is certified that we have submitted tender in compliance with above instructions and we understand

Firm's Authorized Signatures _____

DIRECTORATE PROCUREMENT (NAVY)

Directorate of Procurement (Navy)

Through Bahria Gate

Near SNIDS Centre,

Naval Residential Complex

Contact: For General Queries: 051-9262306

Bahria Gate: 0331-5540649

Section: 051-9262314

Email: adpn33@paknavy.gov.pk

M/s _____

Dated :

INVITATION TO TENDER AND GENERAL INSTRUCTIONS

Dear Sir / Madem,

1. DP (Navy) invites you to tender for the supply of stores/equipment/ services as per details given in attached Schedule to Tender (Form DP-2).

2 Caution: This tender and subsequent contract agreement awarded to the successful bidder is governed by the rules / conditions as laid down in PPRA Rules-2004 and DPP&I-35 covering general terms and conditions of contracts laid down by MoDP / DGDP. As a potential bidder, it is incumbent upon you and your firm to first acquaint yourself with PPRA Rules 2004 (www.ppra.org.pk) and DPP&I-35 (print copy may be obtained from DGDP Registration Cell on Phone No. 051-9270967 before participating in the tender. If your firm / company possesses requisite technical as well financial capability, you must be registered or willing to register with DGDP to qualify for award of contract, which shall be made after security clearance and provision of required registration documents mentioned in Para 15 of this DP-1.

Understood
agreedUnderstood
not agreed

3 Conditions Governing Contracts. The 'Contract' made as result of this I/T (Invitation to Tender) i.a.w PPRA Rules 2004 shall mean the agreement entered into between the parties i.e. the „Purchaser and the „Seller on Directorate General Defence Purchase (DGDP) contract Form “DP-19” in accordance with the law of contract Act, 1872 and hose contained in Defence Purchase Procedure and Instructions and DPP&I-35 and other special conditions that may be added to given contract for the supply of Defence Stores / Services specified herein.

Understood
agreedUnderstood
not agreed

4 Delivery of Tender: The tender documents covering technical and commercial offers are to be furnished as under:-

a Commercial Offer: The commercial offer will be in single copy and indicate prices quoted in figures as well as in words in the currency mentioned in IT. It should be clearly marked in fact on a separate sealed envelope "Commercial Offer", tender number and date of opening. Taxes, duties, freight/transportation, insurance charges etc are to be indicated separately. Total price of the items quoted against the tender is to be clearly mentioned. In case of more than one option offered by the firm, DP(N) reserves the right to accept lowest technically accepted option if more than one options were accepted in Technical Scrutiny Report.

Understood agreed Understood not agreed

b Technical Offer: (Where Applicable). Should contain all relevant specifications in DUPLICATE (or as specified in IT) along with essential literature/brochure, drawings and compliance metrics in a separate sealed envelope and clearly marked "Technical Offer" without prices, with tender number and date of opening. Technical offer shall be opened first; half an hour after the date and time for receipt of tender mentioned in DP-2. Firms are to confirm/comply with IT technical specification in the following format:

Understood agreed Understood not agreed

S. No	Technical requirement as per IT	Firm's endorsement (Comply/Partially Comply/Non Comply)	Basis of C, PC of NC i.e. Refer to page or brochure	In case of non availability of enclosed proof from brochure/ Literature, quote/attach additional documents/data/undertaking as proof of compliance

(Legend: C = Fully Comply, PC = Partially Comply, NC = Not Comply)

(Firms must clearly identify where their offer does not meet or deviates from IT Specs)

c Special Instructions. Tender documents and its conditions may please be read point by point and understood properly before quoting. All tender conditions should be responded clearly. In case of any deviation due to non-acceptance of tender conditions(s), the same should be highlighted alongwith your offered conditions. Tender may however be liable to be rejected.

Understood agreed Understood not agreed

d Firms shall submit their offers in two separate envelopes (i.e. one copy of commercial offer and two copies of the technical offers as asked in the IT) and envelopes clearly marked "Technical proposal", "Commercial proposal" in bold. The commercial offer will include rates of items/services called for and the technical offer will not indicate the rates. Both types of offers are to be enclosed in separate covers and each envelope shall be properly sealed bearing of the bidder. Each cover shall indicate type of offer, number and date of IT and IT opening date. Thereafter both the envelopes (technical and commercial offer) shall be placed in one envelope (second cover) duly sealed and signed. This cover should bear the address

of the procurement agency indicating, issuance date of IT and No, with its opening date. This should be further placed in another cover (third cover), addressed and indicated in the tender documents, without any indication that there is a tender within it.

e FORM DP-1, DP-2, DP-3 and Questionnaires. Form DP-1, DP-2 (alongwith annexes), DP-3 and Questionnaires duly filled in are to be submitted with the technical offer duly stamped/signed by the authorized signatory/ person. It is pertinent to mention that all these are essential requirement for participation in the tender.

Understood agreed Understood not agreed

f. The tender duly sealed will be addressed to the following:-

Directorate of Procurement (Navy)

Through Bahria Gate
Near SNIDS Centre,
Naval Residential

Contact: For General Queries: 051-9262306
Bahria Gate: 0331-5540649
Section: null

Email: dpn@paknavy.gov.pk
null

5 Date and Time For Receipt of Tender. Tender must reach this office by the date and time specified in the Schedule to Tender (Form DP-2) attached. This Directorate will not accept any excuse of delay occurring in post. Tenders received after the appointed/ fixed time will NOT be entertained. The appointed time will, however, fall on next working day in case of closed/forced holiday. Only legitimate/registered representatives of firm will be allowed to attend tender opening. In case your firm has sent tender documents by registered post or courier service, you may confirm their receipt at DP (Navy) on Phone No 051-9271468 well before the opening date / time.

Understood agreed Understood not agreed

6 Tender Opening. Tenders will be opened as mentioned in the schedule to tender. Commercial offers will be opened at later stage if Technical Offer is found acceptable on examination by technical authorities of Service HQ. Date and time for opening of Commercial offer shall be intimated later. Only legitimate / registered representative of firm will be allowed to attend tender opening. Tenders received after date and time specified in DP-2 would be rejected without exception and returned un-opened i.a.w Rule 28 of PPRA-2004.

Understood agreed Understood not agreed

7. Validity of Offer.

Understood agreed Understood not agreed

a. The validity period of quotations must be indicated and should invariably be 120 days from the date of opening of Commercial offer or 30th June whichever is later. Firm undertakes to extend validity of offer if required by equal number of original bid period (i.e. 120 days as per original offer) i.a.w PPRA Rule-26.

b. The quoting firm will certify that in case of an additional requirement of the contract items (s) in any qty(s) within a period of 12 months from the date of signing the contract, these will also be supplied at the ongoing contract rates with discount.

8. Part Bid Firm may quote for the whole or any portion, or to state in the tender that the rate quoted, shall apply only if the entire quantity/range of stores is taken from the firm. The Director Procurement reserves the right of accepting the whole or any part of the tender or portion of the quantity offered, and firm shall supply these at the rate quoted.

Understood agreed Understood not agreed

9. Quoting of Rates. Only one rate will be quoted for entire quantity, item wise. In case quoted rates are deliberately kept hidden or lumped together to trick other competitors for winning contract as lowest bidder, DP(N) reserves the right to reject such offers on-spot besides confiscating firms Earnest Money / Bid Security and take appropriate disciplinary action. Conversion rate of FE/LC components will be considered w.e.f. opening of commercial offer as per PPRA Rule-30(2).

Understood agreed Understood not agreed

10. Return of I/T. ITs are to be handled as per following guidelines:

Understood agreed Understood not agreed

a. In case you are Not quoting, please return the tender inquiry stating the reason of NOT quoting. In case of failure to return the ITs either quoted or not quoted consequently on three occasions, this Directorate, in the interest of economy, will consider the exclusion of your firms name from our future distribution list of invitation to tender.

b. For registered firm(s), case will be referred to DGDP for necessary administrative action if firms registered / indexed for tendered items/stores do not quote / participate.

c. It is a standard practice to invite all firm(s) including those unregistered with DGDP who gave their preliminary budgetary/ technical proposals to end users / indentors. If your firm has been invited to participate in the tender, you must either participate in tender. In case of your inability to do so, you must inform DP (Navy) by a formal letter/email.

11. Withdrawal of Offer. Firms shall not withdraw their commercial offers before signing of the contract and within validity period of their offers. In case the firm withdraws its offer within validity period and before signing of the contract, Earnest Money of the firm shall be confiscated and disciplinary action may also be initiated for embargo up to 01 year.

Understood agreed Understood not agreed

12. Provision of Documents in case of Contract. In case any firm wins a contract, it will deposit following documents before award of contract:

Understood agreed Understood not agreed

- a. Proof of firms financial capability.
- b. Foreign Seller has to provide its Registration Number issued by respective Department of Commerce authorizing export of subject stores.
- c. Principal/Agency Agreement.
- d. Registration with DGDP (Provisional Registration is mandatory)

13. Treasury Challan.

Understood agreed Understood not agreed

a. Offers by registered firms must be accompanied with a Challan form of Rs.200/- (obtainable from State Bank of Pakistan/Government Treasury) and debit able to Major Head C02501-20, Main Head-12, Sub Head 'A' Miscellaneous (Code Head 1/845/30). Each offer will be covered by one Challan.

b. Firms, un-registered / un-indexed with GDP (Registration Section) are to participate in the tender by submitting Challan Form of Rs 300 in favour of CMA (DP).

14. Earnest Money/Tender Bond: Please ensure Earnest Money is contained in a separate envelop (not inside Technical or commercial offer). Offer is liable to be rejected in case Earnest Money is packed inside commercial or Technical offer. Your tender must be accompanied by a Call Deposit Receipt (CDR) in favor of CMA (DP), Rawalpindi for the following amounts:-

Understood
agreed

Understood
not agreed

a. Submitting improper Earnest Earnest Money/Bid Security furnished with tender is strictly in conformity of tender/IT conditions (Clause 14 of DP-1 and clause 10 of DP-2) on the subject. We have no objection on confiscation of Earnest Money/Bid security and rejection of our offer in case amount of Earnest Money/Bid Security is improper/insufficient in violation of IT condition.

b. Rates for Contract. The rate of earnest money and its maximum ceil for different categories OF FIRMS would be as under:-

- (i) Registered/Indexed/Pre-Qualified Firms. 2% of the quoted value subject to maximum ceiling of Rs. 0.500 Million.
- (ii) Registered/Pre-Qualified but Un-indexed 3% of the quoted value subject to maximum ceiling of Rs. 0.750 Million.
- (iii) Unregistered/not Pre-Qualified/Un-indexed 5% of the quoted value subject to maximum ceiling of Rs. 1.000 Million.

c. Return of Earnest Money. (i) Earnest money to the unsuccessful bidders will be returned on finalization of the contract.
(ii) Earnest money of the firm/firms with whom contract is concluded will be returned on submission of Bank Guarantee and its acceptance by CMA (DP).

15. Documents for provisional registration: In case your firm wins a contract on Earnest Money (EM) , it will deposit following documents to DGDP (Registration Section) before the award of contract for provisional registration:-

Understood
agreed

Understood
not agreed

S No	Local Supplier	Foreign Supplier
a.	Three filled copies of SVA-8121 of each member of management.	Three filled copies of SVA-8121-D of each member of management.
b.	Three filled copies of SVA-8121-A	Three filled copies of SVA-8121.
c.	Three photocopies of NIC for each member of management.	Three photocopy of Resident Card or equivalent identification Card for each member of management.
d.	Three PP size photographs for each member of management.r	Three PP size Photographs for each member of management.
e.	Challan Form	Challan Form
f.	Bank Statement for last one year.	Financial standing/audit balance
g.	Photocopy of NTN	Photocopy of passport
h.	Foreign Principal Agency Agreement in case of local agent.	Agency Agreement in case of Trading House/ Company/ Exporter /Stockiest etc.

16. Inspection Authority. CINS, Joint Inspection will be carried out by INS, Consignee and Specialist User or a team nominated by Pakistan Navy. CINS inspection shall be as prescribed in DPP & I-35 or as per terms of the contract.

Understood
agreed

Understood
not agreed

17. Condition of Stores. Brand new stores will be accepted on Firms Warranty/Guarantee Form DPL-15 enclosed with contract.

Understood
agreed

Understood
not agreed

18. Documents Required. Following documents are required to be submitted along with the quote:

Understood
agreed

Understood
not agreed

a. OEM/Authorized Dealer/Agent Certificate along with OEM Dealership Evidence.

b. The firm/supplier shall provide correct and valid e-mail and Fax No to CINS and DP(N). Supplier/contracting firm shall either provide OEM Conformance Certificate to CINS or is to be e-mailed to CINS under intimation to DP (Navy). Hard copy of COC must follow in any case through courier. On receipt, CINS shall approach the OEM for verification of Conformance Certificates issued by OEM. Companies/firms rendering false OEM Conforming Certificates will be blacklisted.

c. Original quotation/Principal/OEM proforma invoice.

d. In case of bulk proforma invoice, a certificate that prices indicated in the bulk proforma invoice have not been decreased since the date of bulk proforma invoice from the manufacturers/suppliers.

e. Submit breakup of cost of stores/services on the following lines:

(i) Imported material with break down item wise along-with import duties.

(ii) Variable business overheads like taxes and duties imposed by the federal/provincial government as applicable:-

(1) General Sales Tax

(2) Income Tax

(3) Custom Duty. PCT code along with photocopy of the related page is to be attached where applicable.

(4) Any other tax duty.

(iii) Fixed overhead charges like labour, electricity etc.

(iv) Agent commission/profit, if any.

(v) Any other expenditure/cost/service/remuneration as asked for in the tender.

19. Rejection of Stores/Services. The stores/services offered as a result of contract concluded against this tender may be rejected as follows:

Understood
agreed

Understood
not agreed

a. 1st rejection on Govt. expense

b. 2nd rejection on supplier expense

c. 3rd rejection contract cancellation will be initiated.

2 0 . Rejection of Stores/Services. To ensure timely and correct supply of stores the firm will furnish an unconditional Bank Guarantee (BG in the currency in which contract is concluded) from a schedule Bank of Pakistan for an amount upto 10 % of the contract value (excluding Taxes, duties/freight handling charges) on a Judicial Stamp Paper (All pages) of the value of (Rs 100.00) as per prescribed format or in shape of CSD/Bank draft. The Bank Guarantee shall be endorsed in favour of CMA (DP) Rawalpindi who is the Accounts Officer specified in the contract. The CMA (DP) Rawalpindi has the like power of seeking encashment of the Bank Guarantee as if the same has been demanded by the purchaser himself. The Bank Guarantee shall be produced by the supplier within 30 days from the date of issue of the contract and remain valid for upto 60 days after completion of warranty period and remain in force till one year ahead of the delivery date given in the contract. If delivery period is extended, the supplier shall arrange the extension of Bank Guarantee within 30 days after the original delivery period to keep its validity always one year ahead of the extended delivery period. The BG form can be obtained from DP(N) on e-mail address given on page 1. Format of BG is enclosed at Annex B.

Understood
agreed

Understood
not agreed

2 1 . Integrity Pact. There shall be "zero tolerance" against bribes, gifts, commission and inducement of any kind or their promises thereof by Supplier / Firm to any Government official / staff whether to solicit any undue benefit, favour or otherwise. Following provisions must be clearly read and understood for strict compliance:

Understood
agreed

Understood
not agreed

a. Integrity Pact shall be applicable to all tenders / contracts irrespective of their financial value. However, a written Integrity Pact shall be signed for contracts exceeding Rs 10 Million between the procuring agency and the supplier / contractor i.a.w Rule-7 of PPR-2004. The form is available at www.ppra.org.pk or can be requested at dpn@paknavy.gov.pk

b. If a Supplier / Contractor is found involved in any unbusiness-like / unethical activity, same would be considered a serious breach of the Integrity Pact. DP (Navy) shall take severe disciplinary action against that person(s) and the firm / company, which may include, but not limited to, PERMANENT BLACKLISTING of firm / company through DGDP and legal action against the individual (s) involved as per Pakistans Code of Criminal Procedure.

c. It is strictly forbidden to socialize, call or meet any official / staff of DP (Navy) in private or during off hours. If any official / staff from Purchaser side asks for any undue favour or gratification directly or indirectly, the matter is to be immediately brought to the personal notice of Director Procurement (Navy) on Respective Section Tel: 051-9271468 or through a personal meeting in office. Privacy of firms and their Reps sharing such information will be guaranteed without any prejudice to their normal business activities.

2 2 . Correspondence. All correspondence will be addressed to the Purchaser i.e. DP (Navy). Correspondence with regard to payment or issue of delivery receipt may be addressed to CMA Rawalpindi and Consignee respectively with copy endorsed to the DP (Navy).

Understood
agreed

Understood
not agreed

2 3 . Pre-Shipment Inspection. PN may send a team of officers including DP(N) member for the inspection of major equipments and machinery items at OEM premises as per terms of contract. If not already provided for and mentioned in the I.T, firm(s) must clarify the place, number of persons, duration and whether expenses on such visits would be borne by the Purchaser or Contractor. In case contractor is responsible for bearing such expenses, detailed breakdown of the same should be given separately in the commercial offer.

Understood
agreed

Understood
not agreed

24. Amendment to Contract. Contract may be amended/modified to include fresh clause (s) modify the existing clauses with the mutual agreement by the supplier and the purchaser; such modification shall form an integral part of the contract

Understood
agreed

Understood
not agreed

25. Discrepancy. The consignee will render a discrepancy report to all concerned within 60 days after receipt of stores for discrepancies found in the consignment. The quantities found short are to be made good by the supplier, free of cost.

Understood
agreed

Understood
not agreed

26. Price Variation.

Understood
agreed

Understood
not agreed

a. Prices offered against this tender are to be firm and final.

b. Where the prices of the contracted stores/raw material are controlled by the government or an agency competent to do so on government behalf then price increase/decrease will be allowed at actual on case to case basis on production of government notification by the Supplier for the subject stores where the firms are contractually obliged and bound to produce the stores from raw materials supplied by government/State controlled departments in consultation with Military Finance.

c. Except for calculation or typographical errors, the rates of the contracts not having a price variation clause PVC clause will not be increased subsequently. But when such an increase is considered desirable in the interest of expeditious supply of stores and is necessitated by the circumstances beyond the control of the Supplier, the case may be decided accordingly.

27. Force Majeure.

Understood
agreed

Understood
not agreed

a. The supplier will not be held responsible for any delay occurring in supply of equipment due to event of Force Majeure such as acts of God, War, Civil commotion, Strike, Lockouts, Act of Foreign Government and its agencies and disturbance directly affecting the supplier over which events or circumstances the supplier has no control. In such an event the supplier shall inform the purchaser within 15 days of the happening and within the same timeframe about the discontinuation of such circumstances / happening in writing. Non-availability of raw material for the manufacture of stores, or of export permit for the contracted stores from the country of its origin, shall not constitute Force Majeure.

b. The Supplier shall provide the Purchaser with all the necessary proof of the occurrence of the events and its effect on the contract performance within 30 days from the start to force majeure event.

c. The Purchaser shall be entitled to conduct investigation into the cause of delay reported by the Supplier.

d. Where the delay was due to genuine force majeure event it shall extend the delivery for a period of equal to the period in which such force majeure remains operative.

e. Such extension in delivery period, due to force majeure, shall not entitle the Suppliers to claim any extra from the Purchaser.

28. Arbitration. Parties shall make their attempt to settle all disputes arising under this contract through friendly discussions in good faith. In the event that either party shall perceive such friendly discussion to be making insufficient progress towards settlement of dispute (s) at any time, then such party may be written notice to the other party refer the dispute (s) to final and binding arbitration as provided below: Understood agreed Understood not agreed

- a. The dispute will be referred for adjudication to two arbitrators one to be nominated by each party, who before entering upon the reference shall appoint an umpire by mutual agreement, and if they do not agree a judge of the Superior court shall be requested to appoint the umpire. The arbitration proceedings shall be held in Pakistan and under Pakistani Law.
- b. The venue of the arbitration shall be the place from which the contract is issued or such other places as the Purchaser at his discretion may determine.
- c. The arbitration award shall be firm and final.
- d. In course of arbitration the contract shall be continuously be executed except that part which is under arbitration
- e. All proceedings under this clause shall be conducted in English language and in writing

29. Court of Jurisdiction. In case of any dispute only court of jurisdiction at Rawalpindi, Pakistan shall have jurisdiction to decide the matter Understood agreed Understood not agreed

30. Liquidated Damages(LD). Liquidated Damages upto 2% per month are liable to be imposed on the suppliers by the purchaser in accordance with DPP & I-35, if the stores supplied after the expiry of the delivery date without any valid reasons. Total value of LD shall not exceed 10% of the contract value. Understood agreed Understood not agreed

31. Risk Purchase. In the event of failure on the part of supplier to comply with the contractual obligations the contract will be cancelled at the Risk and Expense (RE) of the supplier in accordance with DPP & I-35. Understood agreed Understood not agreed

32. Compensation Breach of Contract. If the contractor fails to supply the contracted stores or contract is cancelled either on RE or without RE or contract become ineffective due to default of supplier / seller or stores / equipment declared defective and caused loss to the Government, contractor shall be liable to pay to the Government compensation for loss or inconvenience resulting for his default or from the rescission of his contract when such default or rescission take place such compensation will be in excess to the RE amount, if imposed by the competent authority. Compensation amount in terms of money will be decided by the purchase officer and will be deposited by contractor / seller in Government treasury in the currency of contract. Understood agreed Understood not agreed

33. Gratuities/Commission/Gifts. No commission, rebate, bonus, fee or compensation in any form shall be paid to any local or foreign agent, consultant representative, sales promoter or any intermediary by the Manufacturer/Supplier except the agent commission payable as per the agent commission policy of the government and as amended from time to time and given in the contract. Any breach of such clause(s) of the contract by Manufacturer/Supplier and/or their sole nominated representative may result in cancellation of the contract blacklisting of the Manufacturer/Supplier financial penalties and all or any other punitive measure which the purchaser may consider appropriate.

Understood
agreed

Understood
not agreed

34. Termination of Contract.

a. If at any time during the currency of the contract the Purchaser decides to terminate the contract for any reason whatsoever (other than for reasons of Non-Delivery) he shall have right to do so by giving the Supplier a registered notice to that effect. In that event the Purchaser will accept delivery at the contract price and terms of such stores/goods/services which are in the actual process of manufacture that is completed and ready for delivery within thirty days after receipt by the Supplier of such notice.

Understood
agreed

Understood
not agreed

b. In the case of remainder of the undelivered stores/goods/services the Purchaser may elect either:

(i) To have any part thereof completed and take the delivery thereof at the contract price or.

(ii) To cancel the remaining quantity and pay to the Supplier for the articles or sub-components or raw materials purchased by the Supplier and are in the actual process of manufacture at the price to be determined by the Purchaser. In such a case materials in the process of manufacture shall be delivered by the Supplier to the Purchaser.

c. Should the Supplier fail to deliver goods/services in time as per quality terms of contract or fail to render Bank Guarantee within the stipulated time period or any breach of the contract the Purchaser reserves the right to terminate/cancel the contract fully or any part thereof at the risk and

35. Rights Reserved. Directorate of Procurement (Navy), Rawalpindi reserves full rights to accept or reject any or all offers including the lowest. Grounds for such rejections may be communicated to the bidder upon written request, but justification for grounds is not required as per PPRA Rule 33 (1).

Understood
agreed

Understood
not agreed

36. Application of Official Secrets Act, 1923. All the matters connected with this enquiry and subsequent actions arising there from come within the scope of the Official Secrets Act, 1923. You are, therefore, requested to ensure complete secrecy regarding documents and stores concerned with the enquiry and to limit the number of your employees having access to this information.

Understood
agreed

Understood
not agreed

37. Acknowledgment.
 slips within 07 days from the date of downloading of IT from the PPRA Website i.e.
 WWW.PPRA.ORG.PK

Firms will send acknowledgement

Understood
agreed

Understood
not agreed

38. Disqualification.

Offers are liable to be rejected if:-

Understood
agreed

Understood
not agreed

- a. Received later than appointed/fixed date and time.
- b. Offers are found conditional or incomplete in any respect.
- c. There is any deviation from the General /Special/Technical Instructions contained in this tender.
- d. Forms DP-1, DP-2 (along with Annexes), and DP-3 duly signed, are NOT received with the technical offer.
- e. Taxes and duties, freight/transportation and insurance charges NOT indicated separately as per required price breakdown mentioned at Para 17.
- f. Treasury challan is NOT attached with the technical offer.
- g. Multiple rates are quoted against one item.
- h. Manufacturers relevant brochures and technical details on major equipment assemblies are not attached in support of specifications.
- i. Subject to restriction of export license.
- j. Offers (commercial/technical) containing non-initialed/ unauthenticated amendments/corrections/overwriting.
- k. If the validity of the agency agreement is expired.
- l. The commercial offer against FOB/CIF/CandF tender is quoted in local currency and vice versa.
- m. Principals invoice in duplicate clearly indicating whether prices quoted are inclusive or exclusive of the agent commission is not enclosed.
- n. Earnest money is not provided.
- o. Earnest Money is not provided with the technical offer (or as specified).
- p. If validity of offer is not quoted as required in IT or made subject to confirmation later.
- q. Offer made through Fax/E-mail/Cable/Telex.
- r. If offer is found to be based on cartel action in connivance with other sources/ participants of the tender.
- s. If OEM and principal name and complete address is not mentioned.
- t. Original Principal Invoice is not attached with offer.

39. Appeals by Supplier/Firm.

Any aggrieved Supplier/Firm against the decision of DP (N) or CINS or any other problematic area towards the execution of the contract may prefer an Appeal to Standing Appeal Committee (SAC) comprising PN Officers and military finance rep at Naval headquarters, Islamabad. The detail and timeline for preferring appeals is given below:

Understood
agreed

Understood
not agreed

S.No	Cetegary of Appeal	Limitation Period
a	Appeals for liquidated damages	Within 30 days decision
b	Appeals for reinstatement of contracts	Within 30 days decision
c	Appeals for risk and expense amount	Within 30 days decision
d	Appeals for rejection of stores	Within 30 days decision
e	Appeals in all other Cases	Within 30 days decision

40. Limitation Any appeal received after the lapse of timelines given in para 39 above shall not be entertained.

Understood
agreed

Understood
not agreed

41. For Firms not Registered with For Firms not Registered with DGDP. Firms not registered with DGDP undertake to apply for registration with DGDP prior signing of Contract. Details can be found on DGDP website ww.dgdp.gov.pk. These firms can participate in tender iaw paras 12 and 14 above

Understood
agreed

Understood
not agreed

42. Firms which are not registered with DGDP should initiate provisional registration in accordance with Para 41. Besides, ground check by Field Security (FS) Team will be made for security clearance related to participation in the tender after technical opening. Firms undertake to provide following documents for ground check by FS Team:

Understood
agreed

Understood
not agreed

- a. NTN
- b. Income Tax Return
- c. Sales Tax Return
- d. Sales Tax Certificate
- e. Chamber of Commerce Industry Certificate
- f. Professional Tax Certificate (Excise and Taxation)
- g. Office/Home/Ware House Property documents
- h. Utility Bills (Phone/Electricity)
- j. Firm Vehicle/Personal Vehicle
- k. CEO Visiting Card/NIC Copy, 03Xspecimen signature of CEO
- l. DGDP Registration letter
- m. Firm Bank Statement
- n. Non Black List Certificate
- p. 2 X Witness + CNIC and Mobile Numbers
- q. Police Verification
- r. Agency Agreement
- s. OEM Certificate
- t. ISO Certificate
- u. Stock List with value
- v. Company Profile/Broachers
- w. Employees List
- x. Firm Categories
- y. Sole Proprietor Certificate
- z. Partnership Deed
- aa. Pvt Limited
- ab. Memorandum of Articles
- ac. Form 29 and Form A
- ad. Incorporation Certificate

43. We solemnly undertake that all IT clauses marked as "Understood and Agreed" shall not be changed / withdrawn after tender opening. The IT provisions accepted shall form the baseline for subsequent contract negotiations.

Understood
agreed

Understood
not agreed

44. The above terms and conditions are confirmed in total for acceptance.

Understood
agreed

Understood
not agreed

45. Format of DPL-15 (warranty form) and PBG are enclosed as Annex A and B.

Understood
agreed

Understood
not agreed

Sincerely yours,

(To be Signed by Officer Concerned)

Rank: _____

NAME: _____

INVITATION TO TENDER FORM

1. Schedule to Tender No. 525052\R2605330670. This tender will be closed for acceptance at 1030 Hours and Will be opened at 11:00 Hours on 2026-06-11. Please drop tender in the Tender Box No. 203
2. You are requested to please use this Performa for price quotation, fill in the prices, affix your stamp on the same, sign it and forward it in original as your Commercial offer along with the covering letter of your firm. If you do not use this form as price quotations your offer might be rejected.
3. You are requested to please attach DP-1 and DP-3 alongwith your quotation duly signed and ped. Same are available at www.ppra.org.pk.

S No.	Part No.	Description of Store	Qty/ Unit	Unit Price	Total Price
1.		Stitching of Dress No. 1 & 2 (Summer Ceremonial Square Rig) for Leading and Below (Size wise details will be provided after promulgation of PN Specification)	31,000 Pairs		
Above mentioned price includes 18% Sales Tax (Please tick Yes or No)				Yes	No
Grand Total					

Terms and Conditions

1. Terms of Payment As per Annex B
2. Origin of OEM Indigenous
3. Origin of Stores Indigenous
4. Technical Scrutiny Report Required
5. Delivery Period 50% within 03 Months after receipt of Cloth
50% within 06 Months after receipt of Cloth
6. Currency PAK RUPEES
7. Basis for acceptance FOR
8. Bid validity The validity period of quotations must be indicated and should invariably be 120 days from the date of opening of commercial offer or 30th June whichever is later. Firm undertakes to extend validity of offer if required by equal number of original bid period (i.e. 120 days as per original offer) i.a.w PPRA Rule-26.
9. Tendering procedure Single Stage - Two Envelopes
bidding procedure will be followed , PPRA Rule 36 refers.

10. Earnest Money/Tender Bond

Please ensure Earnest Money is contained in a separate envelop (not inside Technical or commercial offer). Offer is liable to be rejected in case Earnest Money is packed inside commercial or Technical offer. Your tender must be accompanied by a Call Deposit Receipt (CDR) in favor of CMA (DP), Rawalpindi for the following amounts:-

a . Submitting improper Earnest Money/Bid Security Earnest Money/Bid Security furnished with tender is strictly in conformity of tender/IT conditions (Clause 14 of DP-1 and clause 10 of DP-2) on the subject. We have no objection on confiscation of Earnest Money/Bid security and rejection of our offer in case amount of Earnest Money/Bid Security is improper/insufficient in violation of IT condition.

b . Rates for Contract. The rate of earnest money and its maximum ceil for different categories OF FIRMS would be as under:-

- (i) Registered/Indexed/Pre-Qualified Firms. 2% of the quoted value subject to maximum ceiling of Rs. 0.500 Million.
- (ii) Registered/Pre-Qualified but Un-indexed 3% of the quoted value subject to maximum ceiling of Rs. 0.750 Million.
- (iii) Unregistered/not Pre-Qualified/Un-indexed 5% of the quoted value subject to maximum ceiling of Rs. 1.000 Million.

c . Return of Earnest Money. (i) Earnest money to the unsuccessful bidders will be returned on finalization of the contract.
(ii) Earnest money of the firm/firms with whom contract is concluded will be returned on submission of Bank Guarantee and its acceptance by CMA (DP).

13. Special Note.

All Participating firms must submit technical offers in duplicate (one for TSR committee and one for DP (Navy) record).

- a. Unregistered (Not registered with Directorate General Defense Purchase) firms must provide the documentary evidence of their financial capability to undertake the project.
- b. Unregistered firms are to submit a certificate along with their Technical offer stating that the firm is not black listed by any government organization and not under disciplinary trial or embargo.
- c. Only registered suppliers on Active Taxpayers List (ATL) of FBR are eligible to participate in the Tender and submit quote.
- d. Release of payments is subject to mandatory submission of Filer Certificate duly issued by FBR showing the name of supplier on ctiveTaxpayers List (ATL). No payment will be released by CMA (DP) unless latest Filer Certificate duly issued by FBR showing the name of supplier on its Active Taxpayers list is submitted alongwith payment documents.
- e. In case of Pakistani firms, sales tax, NTN and income tax registration certificates are to be attached with the offer. These certificates are mandatory with the BID, otherwise offer shall be REJECTED.
- f. Company registration certificates are to be attached with offer.
- g. Requisite amount of earnest money (in shape of CDR/Demand Draft/Pay Order in the favour of CMA (DP) is to be attached in separate envelop in sealed condition with the Technical offer. Photocopy of the same shall also be attached with DP-2 as a testimony. Cheques/crossed cheques shall not be accepted. Technical offers received without earnest money shall not be accepted and will be rejected on spot.
- h. Duly completed Form DP-1 and DP-3 are to be attached with Technical Offer.
- i. DP-2 Form shall also be submitted with Technical Offer without mentioning of prices. Moreover, compliance or otherwise against each para/requirement of Annex A, B & C duly signed and stamped by firm authorized rep is to provide for technical scrutiny.
- j. Price preference is admissible to local manufacturers over foreign vendors as per PPRA Rule 24 and Govt of Pakistan (Ministry of Commerce) SRO 827 (I)/2001.3
- k. Indent having single item with different sizes will be dealt as a package depending on overall cost/ lowest bid.

Note: In case of failure to comply above instructions, Terms and conditions, offer will liable for rejection.



PAKISTAN NAVY SPECIFICATION No. XX/XY



DRAFT PAKISTAN NAVY SPECIFICATION No. XX/XY
PROMULGATION DATE: MAY 2026

**DRESS NO 1 & 2 (SUMMER
CEREMONIAL) SQUARE RIG FOR
LEADING AND BELOW**

This document is the property of the Pakistan Navy and its use is authorized for personnel in the course of their Inspection, Quality Assurance, Stowage, and Issuance and on need to know basis. The unofficial retention or destruction of this document is an offence.

Prepared by:

Directorate of Inventory Deletion
Naval Research & Development Institute
(NRDI) ITD Wing (South)
at NSSD Area, West Wharf Road
KARACHI

Tel: 021-48508411-9256

Fax: 021-9921476

Email: ditd-s@paknavy.gov.pk

did@paknavy.gov.pk

PAKISTAN NAVY SPECIFICATION No. XX/XY

PROMULGATION ORDER

1. This specification is hereby approved and promulgated for information, guidance and compliance by the relevant person.
2. The details contained in the specification are to be studied, interpreted and implemented with due regards to the interest of the Service.

SUGGESTIONS FOR AMENDMENT

1. The specification has been prepared to bring the test methods and procedures in line with up-to-date PN requirements and facilities held in Pakistan. CINS may request to amend any test requirement/ test procedure in light of the experience emanating from its inspection history, through the feedback form placed at Annex G. However, such an alteration will be effective when the amendment is promulgated by this Directorate, and will be effective on the contracts which materialize after the promulgation date of respective amendment.

PAKISTAN NAVY SPECIFICATION No. XX/XY

CONTENTS	
DESCRIPTION	Page
Promulgation Oder	ii
Suggestions for Amendement	ii
Table of Content	lii
Record of Change/ Amendement	iv
Details	
Designation	1
Usage	1
Introduction	1
Scope	1
Related Document	1
Definition & Abbreviations	2
Technical Details	2
Schedule of Measurement	2
Technical Drawings	2
Manufacturing Guideline	3
Quality of Workmanship and finish	3
Testing	3
Batch /Lot size and No. of samples	3
Tender/ Advance/ Pre-production Sample	4
Inspection	5
Special Instruction	6
Packing detail	6
Identification Label	7
Packing List	7
Marking of Stores	7
Delivery	8
Annexes:	
A. Definition & Abbreviations	9
B. Technical Details	10
C. Technical Drawings	13
D. Schedule of Measurement	17
E. Common Defects in Fabric (ASTM D-3990)	19
F. Acceptable Quality Levels (AQLs)	23
G. Feedback Performa	25
Blank page	26

PAKISTAN NAVY SPECIFICATION No. XX/XY

PAKISTAN NAVY SPECIFICATION NO. XX/XY
DRESS NO 1 & 2 (SUMMER CEREMONIAL) SQUARE RIG
FOR LEADING AND BELOW

0101. **DESIGNATION**

1. Dress No 1 & 2 (Summer Ceremonial) Square Rig for Leading and Below.

0102. **USAGE**

1. Dress No 1 - Full White (Summer Ceremonial) with medals, decorations and authorized insignias for all General Service Branches.
2. Dress No 2 – Service Dress White with Ribbons of medals, decorations and authorized insignias for all General Service Branches.

0103. **INTRODUCTION**

1 This specifications are prepared by Director of Inventory Deletion (DID) of ITD Wing -South, to provide necessary guidance to the potential manufacturers/suppliers of the items mentioned herein. This specifications are to be used for testing and deciding upon acceptance, or otherwise, of the items mentioned. Any alteration or addition in this specification suggested to DID at ITD Wing This specification supersedes/ replace PN Specifications 03/2021 dated 29 Aug 2025 (for Dress No. 1 only). All other specifications / Technical details promulgated earlier in relation to the items mentioned herein.

2. This specification consists **30 pages**, including cover page and **07 Annexes**.

0104. **SCOPE**

1. This specification covers the requirements of one type of Twill cloth from 100% texturized Polyester and stitching of uniform from approved fabric white. This specification lays down the standards to which the store shown under designation above should conform to. It defines and lays down the quality, standards and details of materials, manufacturing, workmanship/ finish, testing, inspection (acceptance & rejection), marking, packing and delivery, etc.

2. The supplier/ manufacturer shall comply in every respect with the terms of this specification and ensure that the stores conform to it, in all respects.

0105. **RELATED DOCUMENTS**

1. The latest standards and documents that have been referred and relevant to in this specification are:

a.	AATCC 20 A	Analysis of fiber
b.	ASTM D 2061	Strength of zippers
c.	ASTM D 2062	Operability of Zippers
d.	ASTM D 5171	Plastic sew through Flange impact resistance

Capr PN M...

PAKISTAN NAVY SPECIFICATION No. XX/XY

e.	ASTM D 2060	Zippers dimensions
j.	ASTM D 6322	Test Method associated with Textile Care Procedures
k.	ASTM D-3990	Standard terminology related to fabric defects.
l.	ASTM D 5430-07	Method for Visually inspecting and grading of fabric
m.	ASTM D 4846	Operability (open /close) of Hook and Eye.
n.	ASTM D 1683	Failure in Sewn Seams of Woven fabrics.
p.	BS EN 3320	Seam Slippage
q.	BS EN ISO-675	Dimensional change on commercial laundering
r.	BS EN ISO-16322-1	Determination of Spirality after laundering.
s.	BS EN ISO-6330	Domestic Washing and Drying procedure
t.	BS EN ISO-25077	Dimensional Change in washing and drying
u.	BS EN ISO 13934-1	Tensile strength
v.	ISO 2859-1	Sampling Procedure for Inspection by attributes
w.	ISO 3801	Weight
x.	ISO 7768	Smooth Appearance
y.	ISO 7211/1	Weave Construction
z.	ISO 7211/2	Threads per inch
aa.	ISO 7211/5	Linear Density
aa.	ISO 7770	Appearance of seam
ab.	ISO 11469	Generic identification of plastic
ac.	ISO 105 CO3/ C10	Color fastness to washing
ad.	ISO 105 E04	Color fastness to perspiration
ae.	ISO 105 B01	Color fastness to light
af.	ISO 105 X 12	Color fastness to rubbing
ag.	PN Specifications 07/2023	White fabric

0106. **DEFINITIONS & ABBREVIATIONS**

1. Definitions for the terms used in this standard are given at Annex A.

0107. **TECHNICAL DETAILS**

1. The technical details of Dress 1 & 2 are enclosed at Annex B.

0108. **SCHEDULE OF MEASUREMENT**

1. All schedule of measurement of Dresses are given at Annex D.

0109. **TECHNICAL DRAWINGS**

1. All technical drawings of Dresses are given at Annex C.

PAKISTAN NAVY SPECIFICATION No. XX/XY

0110. MANUFACTURING GUIDELINE

1. Buttonholes are to have at least 22 stitches per 2 cm and to be bar-tacked or taper barred.
2. All dress are to be made to a high standards and sound tailoring production techniques are to be applied in their construction.
3. Stitches per inch for sewing and over locking thread is 5/7 stitches.
4. All joints at trouser and shirts have single needle stitching with overlock.
5. The sewing thread should match with the main fabric spun polyester.
6. On trouser pockets end and waist loops are to be reinforced with suitable mean of stitching (less N.o of stitch per inch).
7. Good quality of bukram/ fusing shall be used in collar and flaps.
8. The collar is to be free from distortion.
9. Zippers is made of polymeric coil chain of YKK or equal brand.
10. Care label instruction shall be attached with shirts and trousers.
11. Strict compliance of Quality Control and Quality Assurance parameters will be implemented through Internal /External audit teams, before commencement of PN Inspection.

0111. QUALITY OF WORKMANSHIP AND FINISH

1. Workmanship and finish of the uniform shall be best of its class and to entire satisfaction of the INS.
2. The stitched dress shall confirm the parameters define at Annex B of this specification.

0112. TESTING

1. The material shall be subjected to tests laid down in this specification at Annex B of this specification and also be subjected to such tests, which are deemed necessary by the Inspection Authority in order to determine their suitability. Inspecting authority reserves the right to get any B/R samples tested from any reputable Laboratory other than PN. Firm is liable to pay all the testing charges.

0113. BATCH/ LOT SIZE AND NO OF SAMPLE

1. Number of samples (various sizes) required to be drawn from bulk quantity/ offered store for testing/ evaluation are as follows Or As per instruction of Inspecting Officer:

PAKISTAN NAVY SPECIFICATION No. XX/XY

Lot Size	Quantity
300 ≥1300	05
1301 ≥8000	10
8001 ≥110000	15
≥110001	20

0114. **TENDER/ ADVANCE / PRE-PRODUCTION SAMPLE**

1. Tender sample is to be approved by TSR Committee.
2. Whenever Tender, Advance or pre-production sample is not required, the suppliers / manufacturer are advised in their own interest to submit to the Inspecting Officer or his representative an initial delivery of One % of the contract.
3. Advance sample or pre-production sample, when required, shall be submitted in accordance with terms of the contract PN Specification for inspection and testing.
4. For each contract following material shall be supplied by the manufacturer at the time of advance samples/ preproduction/ tendering:

a.	Fabric white	04 meters
b.	Stitch uniform	04 x uniform
c.	Zippers	10x Nos
d.	Stitching Thread and over locking	50x Grams/ 01 reel
e.	Care Label/ Washing Instruction	10x Pieces
f.	Hook & Retainers	10 x samples each
g.	Buckram /fusing	05 x meters

5. The approval of the sample, authorizes the commencement of bulk production but does not relieve the suppliers/ manufactures from compliance with all the provisions of this specification.
6. One approved sample after rectification of all observations highlighted by Inspecting Officer/ end user shall be properly sealed by INS and returned to the firm for guidance; rest of the approved sample shall be retained by INS for future use in bulk Inspection, (If deemed necessary).
7. The Pre-production sample shall be manufactured by the manufacturer with the same facilities which will be used for manufacturing of the bulk items.
8. Firm shall provide advance sample along with quality verification reports from an accredited laboratory, whenever asked/ required by Inspecting authority to ensure compliance of quality assurance parameters during production/ final internal inspection.

PAKISTAN NAVY SPECIFICATION No. XX/XY

0115. **INSPECTION**

1. **Bulk representative sample.** B/R random sampling will be carried out as per rules in vogue.
2. **Bulk Inspection.** Bulk inspection will be carried out after satisfactory completion of Visual Examination and Testing of B/R Sample.
3. **Inspection of Stitched.** 100% of the offered/ store shall be inspected as per procedure in vogue OR predefine Stage inspection OR as per Annex F (AQLs).
4. **Inspection/ Acceptance and Rejection of Stores.** Inspection/ acceptance is to be carried out to the entire satisfaction of Chief Inspector of Naval Stores and also as per instruction/ procedure laid down in Official unit order instruction.
5. Common defects in garments is enclosed as Annex E for consultation/ guideline. However these guide lines may be considered by Inspecting officer in addition to Unit Instruction Order or as per order of Inspecting Authority.
6. CINS reserves the right to reject the whole supply in case, upon examination, material or packing of any sample or portion of the consignment is found '**NOT CONFORMIN**' the parameters laid down in this specification or the quality of product does not seems up to the mark.
7. If on examination of 5% of any delivery, 20% of those examined from bulk supply are found '**NOT CONFORMING**' to this specification in respect of the pattern, dimensions, workmanship and finish, the whole consignment may be rejected without any compromise.
8. All stores and packing '**NOT**' fully in accordance with this specification shall be rejected.
9. **Responsibility for Compliance.** The inspection set forth in this specification shall become a part of the supplier's overall inspection system or quality program. The absence of any inspection requirements in the specification shall not relieve the contractor of the responsibility of ensuring that all products or supplies submitted to PN for acceptance comply with all requirements of the contract. Sampling inspection, as part of manufacturing operations, is an acceptable practice to ascertain conformance to requirements. However, this does not authorize submission of known defective material, either indicated or actual, nor does it commit PN to acceptance of defective stores (material).
10. **Responsibility of contractor.** The contractor is responsible for the performance of all inspection requirements (inspection /examination and test) as specified here in. except as otherwise specified in the contract or purchase order, the contractor may use his own or any other facilities suitable for performance of the inspection requirements.

PAKISTAN NAVY SPECIFICATION No. XX/XY

11. **Replacement by the Contractor.** The supplier/ manufacture is responsible for replacement of the consignment or any part there of whenever it is found to be not conforming to this specification or does not curtain its quality till the useful life of an item. The supplies so tendered in replacement, shall be subjected to testing/Inspection and acceptance by the Inspecting Officer.

12. **Responsibility for Safety.** The supplier/manufacture is wholly responsible for the safety of supplies during inspection, storage at firm's premises, proper packing, dispatch and delivery up to consignee.

13. The CINS is the authority in all matters pertaining to Inspection.

14. **Stamping of Accepted/ Rejected Stores by the Inspector.** Following instructions are to be followed:

a. **Stamping of Accepted Stores.** Each acceptable dress shall be stamped with Inspector's Individual Acceptance mark or as per Instructing of Inspecting Authority. The stamping shall be legible.

b. **Stamping of Rejected Stores.** The rejected uniform shall be marked with Inspector's Rejection marked at the back/ visible place of uniform to avoid re-submission by the supplier.

0116. **SPECIAL INSTRUCTIONS**

1. **Care Instructions.** Care instructions in English and Urdu shall be attached with each Dress as indicated in the drawing and have minimum requirement as follows:

- a. Ironing Procedure.
- b. Washing/ Dry cleaning procedures.
- c. Any Prohibition i.e. Do not use bleach / chlorinated water.

0117. **PACKING DETAILS**

1. The store when ordered to be delivered '**PACKED**' shall be packed as per following instructions:

- a. Each Stitched Dress shall be properly folded length wise.
- b. The Stitched Dress shall be packed in a neat, dry and clean condition in polyethylene bag of thickness of 0.06mm (± 0.01 mm) and suitable size.
- c. Ten x trouser and shirts shall be further packed, separately in a thick Boxboard/corrugated Carton/ Flouing.
- d. Each Box Board packing shall be securely and properly packed.
- e. Each box board shall consist of same size.

PAKISTAN NAVY SPECIFICATION No. XX/XY

0118. IDENTIFICATION LABEL

1. Each dress shall bear following minimum information:
 - a. Item name/ item description with NSN/Pattern No.
 - b. Material Composition.
 - c. Contract number and Date.
 - d. Year of manufacture.
 - e. Contractor's name, initials, or trade mark.
 - f. Batch N.o / Bar code
 - g. Identification of face at suitable places on the fabric.
 - h. Size sticker.

0119. PACKING LIST

1. Firm is bound to provide a packing list of store offered for inspection along with the challan and each packed box giving full, which include complete details about the store i.e. Pattern No., Description of Store, size, quantity, Contract No, & date, challan No & date, I/Note No. or Voucher No. with date, Consignee, Firm's Name, Date of packing, Packer's Signature and Stowage/ Stacking Instruction.

0120. MARKING OF STORES

1. In addition to any special marking required by contract or order, the marking of packages shall be stenciled with quick drying Black ink/ Paint in accordance with Specification No. NS/MISC/002/80 with clearly defined characters as described below:

- a. On Front and Top:
 - (1) Consignee Address.
 - (2) Contract No and date.
 - (3) Description of Stores Packed and NSN/ Patt no.
 - (4) Stowage / Stacking Instruction.
 - (5) Quantity of the Item packed.
 - (6) Weight of the Carton.
- b. On Back:
 - (1) Manufacturers name / Firm's name.
 - (2) Voucher No. or Inspection Note No. and date.
 - (3) The No. of individual Package and the total No of Packages in the consignment joined by the word 'of 'e.g. 2 of 300.
 - (4) Weight of the package.
 - (5) Month and year of packing.
 - (6) Delivery Challan No. and date.

PAKISTAN NAVY SPECIFICATION No. XX/XY

0121. **DELIVERY**

1. The consignment of store will be delivered in accordance with the terms of contract.
2. The store shall be delivered in Brand new, clean and dry condition.
3. The contractor / manufacturer is fully responsible for the safety of the supplies during inspection, storage at firms and consignee premises proper packing, dispatch and delivery up to consignee.

RAO MUZAFFAR ALI
Captain Pakistan Navy
Director

Annexes:

A.	Definition & Abbreviations	9
B.	Technical Detail	10
C.	Technical Drawings	13
D.	Schedule of Measurement	17
E.	Common Defects In Fabric (ASTM D-3990)	19
F.	Acceptable Quality Levels	23
G.	Feedback Performa	25

PAKISTAN NAVY SPECIFICATION No. XX/XY

ANNEX A TO
PN SPECIFICATION NO XX/XY
PROMULGATION DATE

DEFINITIONS & ABBREVIATIONS

1. **DEFINITIONS**

a. The following definitions are relevant in this specification:

(1). **Inspector**. The term inspector shall include the "Inspection Authority", inspecting officer and their representatives, duly authorized for the purpose of discharging inspection duties involved.

(2). **Inspection Authority**. It is the authority holding sealed particulars and responsible for laying, down the standard of stores falling under his responsibility. His verdict in respect of inspection matters is to be taken as final.

(3). **Inspecting Officer**. He is an officer nominated by the purchase officer for carrying out inspection of stores supplied by the supplier, against a specified contract or order, in accordance with the particulars stipulated therein.

2. **ABBREVIATIONS**

a. Following abbreviations are used in this specification and will be adopted for use:

- | | | |
|-----|-----------------------|---|
| (1) | <u>CINS</u> : | Chief Inspector of Naval Stores. |
| (2) | <u>DID</u> : | Director of Inventory Deletion. |
| (3) | <u>DCLS</u> : | Director of Clothing Stores. |
| (4) | <u>PNCSD</u> : | Pakistan Navy Clothing Store Depot. |
| (5) | <u>PNCTA</u> : | Pakistan Navy Central Testing Authority |

PAKISTAN NAVY SPECIFICATION No. XX/XY

**ANNEX B TO
PNSPECIFICATION NO XX/XY
PROMULGATION DATE**

TECHNICAL DETAILS

S. No	Item	Standards	Requirement
1.	FABRIC WHITE		PN Specification 07/2023
a.	Whole Dress (appearance after 05/10 cycles at 60/40 °C of laundering) (1) Colour (2) Spirality (3) Wrinkles/ smooth appearance (4) Seam (5) For buckram/ fussing (6) Zippers (7) Hook /retainers.	BS EN ISO 6330/ BS EN ISO 25077 Visual BS EN ISO 16322 ISO 7768 ISO 7770 Visual/ Manual	GS 4 & No paleness/ dullness 02 % SA 4 or better No pucker Adhere bond , bubble ,cracking Distortion or removal of any protecting coating or corrosion are not permissible.
b.	Seam Strength	ASTM D 1683	240-260 lbs
2.	SEWING THREAD (For stitching / Over locking)		
a.	Material	AATCC 20 A	100 %Polyester
b.	No of stitches per inch(SPI)	Visual/ Manual	5/7
c.	Shade		White or Match with main fabric
d.	Construction	ISO 7211/1	Spun Thread
3.	ZIPPERS (YKK or Equivalent)		
a.	Tape Material	AATCC 20 A	Polyester
b.	Color	Visual	White/ matched with white dress
c.	Elements/ coil zippers	ISO 11469	Polymeric material
d.	Zipper parts (1) Top stop (2) Open parts (3) Zipper slider	Chemical analysis	Brass Aluminum Zinc Alloy
e.	Operating force (N)	ASTM D 2061	3.9 N
f.	Cross wise (N)		350N
g.	Top Stop Strength		60N
h.	Bottom stop strength		50N
j.	Slider Lock Strength		15 N
k.	Slider Mouth and pull holding strength		80N

PAKISTAN NAVY SPECIFICATION No. XX/XY

l.	Puncture (N)		200N
m.	Durability		500 cycles
4. WAIST SIDE BUCKLES/ RETAINER HOOK			
a.	Material	Chemical analysis	Stainless steel
b.	Resistance to corrosion	Salt water 24 hrs test	No corrosion / removal of coating
5. BUCKRAM/ FUSSING			
a.	Material	AATCC 20 A	Cotton
b.	Wt/ Sq mtr	ISO 3801	162 g/m ²
c.	Threads / 2.5cm (1) Warp (2) Weft	ISO 7211/2	66 53
6. BUTTONS			
a.	Material	Chemical analysis	Polyvinyl (heat resistance)
b.	Shade	Visual analysis	White
7. TAPE COMPOSITION			
a.	Material	AATCC 20 A	Synthetic Fibre/ Polyester
b.	Construction	Visual analysis	Grosgrain/ Petersham
c.	Thickness		0.37 ± 0.10MM
d.	Width		20mm
8. BOW TAPE BLACK			
a.	Material	AATCC 20 A	Wool worsted
b.	Shade	Visual	BCC 49 or equivalent pantone
c.	Dye fastness to washing	ISO 105 C03	GS 4 or better
d.	Dye fastness to perspiration	ISO 105 E04	GS 4 or better
e.	Dye fastness to light	ISO 105 B01 / A02	Grade 6 (minimum)
9. COLLAR BLUE JEAN			
a.	Material	AATCC 20 A	100 % polyester
b.	Linear density (1) Warp (2) Weft	ISO 7211-5	160 denier 300 denier
c.	Number of threads/ inch (1) Warp (2) Weft	ISO-7211/2	180 70
d.	Width	Visual	56/57 inches
e.	Weight/ Sq mt	ISO 3801	235 GSM
f.	Dyes	Chemical Analysis	Disperse
g.	Weave	Visual	Twill 3/1
h.	Dimensional stability	BS EN ISO-6330 (4N)	2%

PAKISTAN NAVY SPECIFICATION No. XX/XY

j.	Breaking Strength (BS 5x20 cm) (1) Warp (2) Weft	ISO-13934-01	180 Kg 150
k.	Color	Visual	Navy Blue
l.	Color fastness to washing	ISO-105-C10 (C3)	GS 4 or better
m.	Color fastness to perspiration	ISO-105-E04	GS 4 or better
n.	Color fastness to rubbing (1) Dry (2) Wet	ISO 105 X 12	GS 4 or better GS 4 or better
10. INNER CLOTH/ POCKET			
a.	Waist Band	Visual	Fused Buckram
b.	Pocket	AATCC 20A	Cotton
11. EMBROIDERY THREAD (BLUE)			
a.	Construction	Visual Analysis	03 Cord each single
b.	Material	AATCC 20 A	Polyester
c.	Count of yarn	ISO-7211/5	3/13Tex
d.	Shade (Blue)	Visual Analysis Pantone shade (TCX)	15-3920
e.	Balance of Twist	Visual Analysis	3
f.	Direction of Twist	Visual Analysis	S-type

TECHNICAL DRAWING

ANNEX C TO
PN Specification No 00/2026
Promulgation Date:

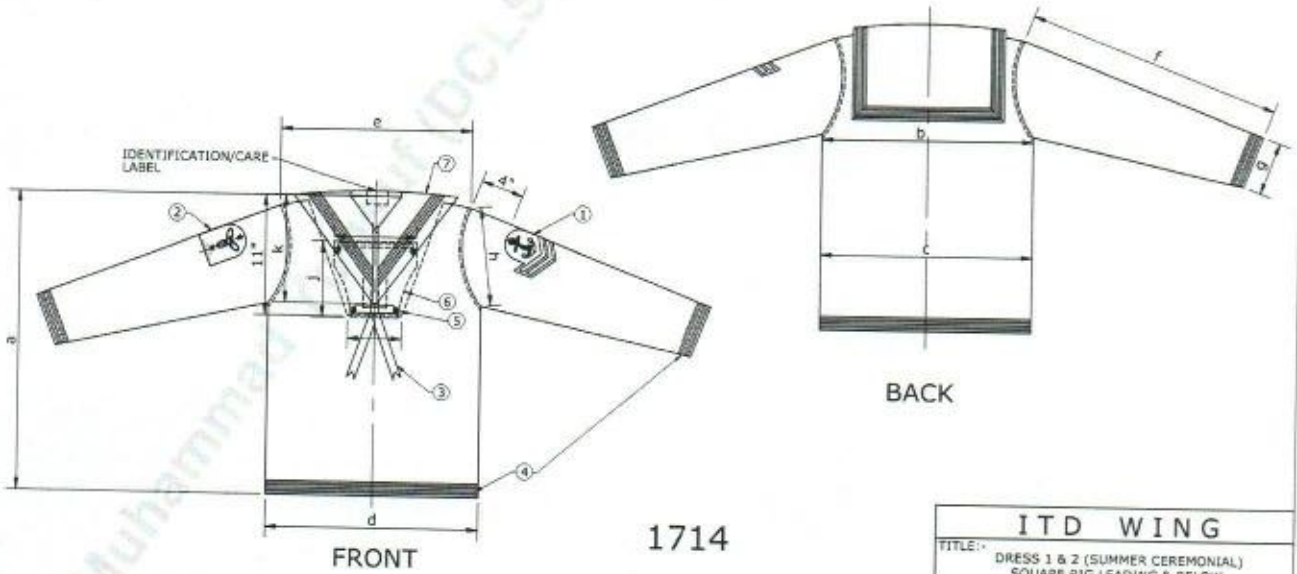

1714

ITD WING		
TITLE: DRESS 1 & 2 (SUMMER CEREMONIAL) SQUARE YOK LEADING & BELOW SHIRT (MAIN BODY)		
DWG NO: TD-2306/2026		DIMENSION: INCHES
DATE: 26-01-2026		SCALE: NTS
REVISION NO: 00	REV. DATE: 00-00-0000	
DRAWN BY	CHECKED BY	APPROVED BY
HDM M.ASGHAR I/c DWG	LT CDR SANA KANWAL DD TECH TEX	CAPTAIN RAO MUZAFFAR ALI D/D

1	COLLAR WIDTH BOTTOM
2	COLLAR WIDTH TOP
3	COLLAR LENGTH
4	ARM HOLE
5	SLEEVE OPENING
6	SLEEVE LENGTH
7	SHOULDER
8	BOTTOM
9	WAIST
10	CHEST
11	LENGTH FROM CENTER BACK

NOTE:-
FOR FURTHER DETAILS SEE STOCK/APPROVED SAMPLE.

TECHNICAL DRAWING

ANNEX C TO
PN Specification No. 00/2026
Promulgation Date:

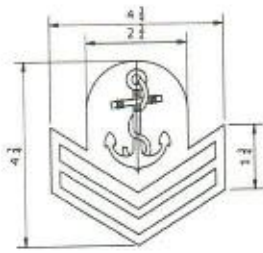

ARM BADGE
DETAIL-1

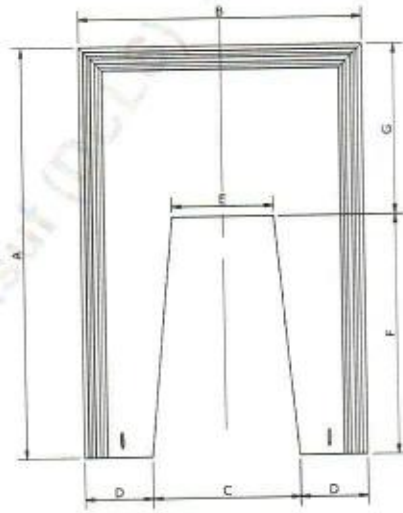

COLLAR
DETAIL-7

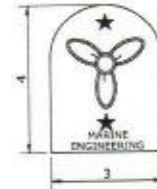

ARM BADGE
DETAIL-2

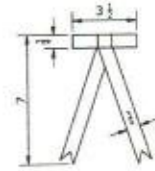

BLACK BOW
DETAIL-3



STRIP
DETAIL-4

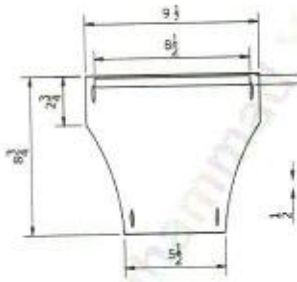

BIB
DETAIL-6



BUTTON
DETAIL-5

1715

ITD WING

TITLE:- DRESS 1 & 2 (SUMMER CEREMONIAL) SQUARE RIG LEADING & BELOW SHIRT (SMALL PARTS)		
DWG NO: TD-2907/2026	DIMENSION: INCHES	
DATE: 27-01-2026	SCALE: NTS	
REVISION NO. 00	REV. DATE: 00-00-0000	
DRAWN BY	CHECKED BY	APPROVED BY
HDM M. ASGHAR 1/c DWG	LT CDR SANA KANWAL DO TEX TECH	CAPTAIN RAO MUZAFFAR ALI DID

G	COLLAR HEIGHT FROM CENTER BACK
F	COLLAR FRONT END
E	COLLAR BACK OPENING
D	COLLAR FRONT END WIDTH
C	DISTANCE B/W FRONT ENDS
B	WIDTH OF COLLAR
A	OVER ALL LENGTH

NOTE:-
FOR FURTHER DETAILS SEE STOCK/APPROVED SAMPLE.

TECHNICAL DRAWING

ANNEX C TO
PN Specification No 00/2026
Promulgation Date:

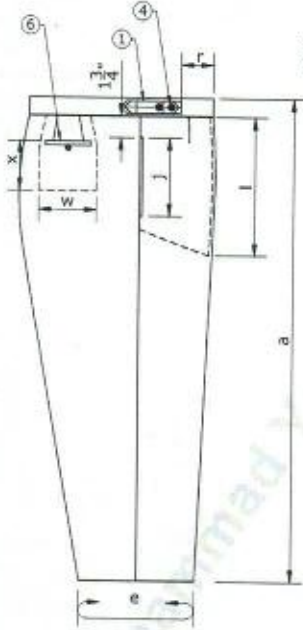

SIDE

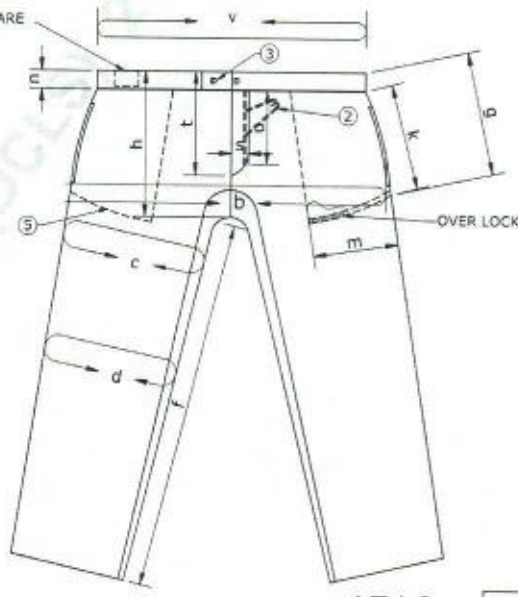

FRONT

1716

IDENTIFICATION/CARE LABEL

OVER LOCK

NOTE:-
FOR FURTHER DETAILS SEE STOCK/APPROVED SAMPLE.

E	FLY LENGTH	I	SIZE SCKET OVERLAP
S	FLY WIDTH	H	BACK RISE
F	PLACEMENT OF LOOP AT BELT	G	HEIGHT BARS (INCLUDED) BELT
D	BELT LOOP WIDTH	F	WRIST
P	BELT LOOP LENGTH	E	NOTION
R	WALLET BELT	D	WIDE
M	SIZE SCKET OVERLAP	C	THICK
X	WASH	L	SIZE SCKET DEPTH UNDER
U	ZIP	R	SIDE SCKET OUTER LENGTH
		A	LENGTH

ITD WING		
TITLE: DRESS 1 & 2 (SUMMER CEREMONIAL) SQUARE RIG LEADING & BELOW TROUSER (MAIN BODY)		
DWG NO: TD-2908/2026	DIMENSION: INCHES	
DATE: 28-01-2026	SCALE: NTS	
REVISION NO. 00	REV. DATE: 00-00-0000	
DRAWN BY	CHECKED BY	APPROVED BY
HDM M.ASGHAR I/c DWG	LT CDR SANA KANWAL DD TEX TECH	CAPTAIN RAD MUZAFFAR ALI DID

TECHNICAL DRAWING

BELT LOOP
DETAIL-1

INNER FLAP
DETAIL-2

HOOK
DETAIL-3

BUTTON
DETAIL-4

FRONT POCKET
DETAIL-5

BACK POCKET
DETAIL-6

ITD WING

TITLE:- DRESS 1 & 2 (SUMMER CEREMONIAL)
SQUARE RIG LEADING & BELOW TROUSER (SMALL PARTS)

DWG NO: TD-2998/2026 DIMENSION: INCHES
DATE: 29-01-2026 SCALE: NTS
REVISION NO. 00 REV. DATE: 00-00-0000

DRAWN BY	CHECKED BY	APPROVED BY
HDM M. ASGHAR I/C DWG	LT CDR SANA KANWAL DD TEX TECH	CAPTAIN RAO MUZAFFAR ALI D/D

NOTE:-
FOR FURTHER DETAILS SEE STOCK/APPROVED SAMPLE.

16

PAKISTAN NAVY SPECIFICATION No. XX/XY

**ANNEX D TO
PN SPECIFICATION NO XX/XY
PROMULGATION DATE**

**SCHEDULES OF MEASUREMENT
(SUMMER CEREMONIAL) SQAURE RIG**

1. DRESS NO.1 & 2 (UPPER) IN INCHES (LEADING & BELOW)																		
S.NO	DESCRIPTION	2XS	XXS	XSF	XSL	SF	SL	MF	ML	LF	LL	XLF	XLL	XXL	2XXL	3XXL	4XXL	TOL
		32	34	36	36	38	38	40	40	42	42	44	46	48	50	52	54	±
a.	Length from center back	28.5	29.5	28	30	28	30	28	30	29	31	31	31	31	31	32	32	0.75
b.	Chest	19	20	21	21	22	22	23	23	24	24	25	26	27	28	29	30	0.5
c.	Waist	18	19	20	20	21	21	22	22	23	23	24	25	26	27	28	29	0.5
d.	Bottom	19	20	21	21	22	22	23	23	24	24	25	26	27	28	29	30	0.5
e.	Shoulder	17.0	17.5	18	18	18.5	18.5	19	19	19.5	19.5	20.3	21	21	21	21.5	21.5	0.5
f.	Sleeve Length	22	23	23	25	23.5	25	23.5	25	23.5	25	24.5	25	25	25.5	25.5	25.5	0.25
g.	Sleeve opening	4.5	4.5	4.75	4.75	5	5	5	5	5	5	5.25	5.25	5.25	5.25	5.5	5.5	0.25
h.	Arm hole	8	8.25	8.5	8.5	8.75	8.75	9	9	9.25	9.25	9.5	9.75	10	10.3	10.5	10.8	0.5
j.	Bib length	8.75	8.75	8.75	8.75	8.75	8.75	8.75	8.75	8.75	8.75	8.75	8.75	8.75	8.75	8.75	8.75	0.13
k.	Bib width top	9.5	9.5	9.5	9.5	9.5	9.5	9.5	9.5	9.5	9.5	9.5	9.5	9.5	9.5	9.5	9.5	0.25
l.	Bib width bottom	5.5	5.5	5.5	5.5	5.5	5.5	5.5	5.5	5.5	5.5	5.5	5.5	5.5	5.5	5.5	5.5	0.13

COLLAR BLUE JEAN (IN mm)							
SIZE	A OVER ALL LENGTH	B WIDTH OF COLLAR	C DISTANCE B/W INTO FRONT END	D COLLAR FRONT WIDTH	E COLLAR BACK OPENING	F COLLAR FRONT END	G COLLAR HEIGHT OF CENTER BACK
14	560	350	260	72.1	140	320	240
14 1/2	560	367	293	74.0	150	330	230
15	573	385	230	80.0	145	338	235
15 1/2	365	385	305	80.0	170	320	245
16	560	405	320	80.0	170	315	245
16 1/2	555	410	305	90.0	165	305	250
17	565	423	315	90.0	175	315	250

PAKISTAN NAVY SPECIFICATION No. XX/XY

**SCHEDULES OF MEASUREMENT
(SUMMER CEREMONIAL) SQAURE RIG**

2. TROUSERS DRESSES 1 & 2 IN INCHES (LEADING & BELOW)															
S. No	Description	XXS	XSL	SL	ML	LL	XLF	XLL	XXL	XXL1	XXL2	XXL3	XXL4	TOL	
Sizes		1	2	3	4	5	6	7	8	9	10	11	12		
a.	Length	46													
b.	Hip	35	37	39	41	43	45	47	49	51	53	55	57	1	
c.	Thigh	24	25	26	27	28	29	30	31	32	33	34	35	1	
d.	Knee	18	18	18.5	18.5	19	19	20	20	20.5	20.5	21	21	0.5	
e.	Bottom	16	16	16.5	16.5	17	17	17.5	17.5	18	18	18.5	18.5	0.5	
f.	Inseam	35.5	35.5	35	35	34.5	34.5	34.5	34.5	34	34	34	33.5	1	
g.	Front rise including belt	11	11.25	11.5	11.75	12	12.25	12.5	12.75	13	13.25	13.5	13.5	0.5	
h.	Back rise	16	16.25	16.5	16.75	17	17.25	17.5	17.75	18	18.25	18.5	18.5	0.5	
i.	Side pocket opening	6.5	6.5	6.5	6.5	6.5	6.5	6.5	6.5	6.5	6.5	6.5	6.5		
k.	Side pocket outer length	11	11	11	11	11	11	11	11	11	11	11	11		
l.	Side pocket depth inner	12.5	12.5	12.5	12.5	12.5	12.5	12.5	12.5	12.5	12.5	12.5	12.5	0.25	
m.	Side pocket width	6.75	6.75	6.75	6.75	6.75	6.75	6.75	6.75	6.75	6.75	6.75	6.75	0.25	
n.	Waist belt	1.75	1.75	1.75	1.75	1.75	1.75	1.75	1.75	1.75	1.75	1.75	1.75		
p.	Belt loop length	1.85	1.85	1.85	1.85	1.85	1.85	1.85	1.85	1.85	1.85	1.85	1.85		
q.	Belt loop width	0.5	0.5	0.5	0.5	0.5	0.5	0.5	0.5	0.5	0.5	0.5	0.5		
r.	Placement of front loop at belt	Front Centre													
s.	Fly width	1.5	1.5	1.5	1.5	1.5	1.5	1.5	1.5	1.5	1.5	1.5	1.5		
t.	Fly length	6.5	7	7	7	7	7.5	7.5	7.5	8	8	8	8	Nil	
u.	Zip	6	6.5	6.5	6.5	6.5	7	7	7	7.5	7.5	7.5	7.5		
v.	Waist	28	30	32	34	36	38	40	42	44	46	48	50	1	

PAKISTAN NAVY SPECIFICATION No. XX/XY

ANNEX E TO
PN SPECIFICATION NO XX/XY
PROMULGATION DATE**COMMON DEFECTS IN FABRIC (ASTM D-3990)**1. **COMMON DEFECTS IN FABRIC**

- a. **Abrasion Mark (bruise, Chafe Mark or rub)**. An area of fabric damaged by friction Damaged due to abraded or uneven surface in a machine.
- b. **Baggy or wavy cloth**. Cloth that will not lie flat on a Cutting Table Tight or loose yarn either in warp or filling (weft).
- c. **Barré Mark**. An unintentional, repetitive visual pattern of continuous bars and stripes usually parallel to the filling of woven fabric or to the courses of circular knit fabric. Barré can be caused by physical, optical, or dye differences in the yarns, geometric differences in the fabric structure, or by any combination of these differences.
- d. **Blotch**. An off colored area of any shape caused by grease or Oil. (Syn. oil spot). Cause due to leakage/slippage .from machine.
- e. **Bow**. A fabric condition resulting when filling yarns or knitting courses are displaced from a line perpendicular to the selvages and form one or more arcs across the width of fabric.
- f. **Broken filament**. In multifilament yarn, breaks in one or more filaments.
- g. **Clip mark**. An open place causing a streak of variable length approximately parallel of the length of width.
- h. **Decanting Mark**. A crease marks or impression extending across the cloth near the beginning or end of a piece Due to the thickness of the fabric leader seam.
- j. **Double Pick**. In woven fabrics, two picks wrongly place in the same shade.
- k. **Draw Back**. A weave distortion characterized by tight and stack places in the same warn yarn.
- l. **End out**. A void caused by a missing warn yarn.

PAKISTAN NAVY SPECIFICATION No. XX/XY

- m. **Float**. In woven fabrics, the portion of a warp or filling yarn that extends unbound over two or more warp or filling yarns, in knitted fabrics, that portion of a yarn that is not knitted into loops.
- n. **Filling Band**. In woven fabrics, visual defect across the width due to a change occurring in the yarn for a large number of picks.
- p. **Frosting**. A change in color in a limited area of fabric caused by abrasive wear.
- q. **Hole**. In fabric, imperfection, where one or more warp or filling yarns are sufficiently damaged to create an aperture.
- r. **Fuzzy**. Characterized by a hair appearance due to protruding broken fibers or filaments.
- s. **Let-off Mark**. In woven fabrics, a corrugated defect pattern distributed across the fabric width.
- t. **Loom fly**. Waste fibers created during weaving that are woven into a fabric.
- u. **Loop Salvage**. An improperly woven salvage of uneven width or a salvage containing irregular filling loops extending beyond the outside edges.
- v. **Messiness**. Surface distortion in a fabric characterized by objectionable unevenness due to many minor deformations.
- w. **Pin Hole**. In fabric, a very small hole, approximately the size of the cross section of the pin.
- x. **Pin Mark**. A series of holes near the edge parallel with the lengthwise direction of a fabric caused by the holding device on the pin tender frame.
- y. **Read Mark**. In woven fabric, a crease between groups of warp ends, either continuous or at intervals.
- z. **Scalloped Salvage**. An abrupt, narrow indentation in the salvage.
- aa. **Salvage Mark**. In finished cloth, a lengthwise crease mark along the salvage caused by an edge being folded or doubled.
- ab. **Shiner**. A streak, usually short caused by a lustrous section of filament yarn.

PAKISTAN NAVY SPECIFICATION No. XX/XY

- ac. **Smash.** In woven fabrics, relatively large hole characterized by broken worn ends and floating picks.
- ad. **Skew.** A fabric condition resulting when filling yarns or knitted course are angularly displace from a line perpendicular to the edge or side of the fabric.
- ae. **Snag.** In fabrics, a yarn or part of a yarn pulled or plucked from the surface.
- af. **Thin Place.** In fabric, an intentionally in a fabric appearance characterized by a small area of loosely placed yarn or by a congregation of thin yarn as compared to the adjacent construction
- ag. **Tight Salvage.** In woven fabrics, salvage yarn shorter than worn yarn in the body of the fabric.
- ah. **Streak.** An extended unintentionally strips narrow width, often a single yarn
- ai. **Tram Mage.** In woven crepes, a puckered area in which a filling yarn has twist running in the same direction for several picks instead of alternating S and Z twist
- aj. **Temple Mark.** In woven fabrics, small holes or distortions adjacent to the salvage.
- ak. **Tender Mark.** A visible deformation on the side edge or body of a fabric due to pressure for clips or pins.

2. **MATERIAL DEFECT AND WORKMANSHIP DAMAGES**

- a. Any hole, scissor or knife tear, mend, burn or weakening defect, such as smash, multiple float, loose slub, or needle chews, that might develop in to hole.
- b. Cloth stiffened, hardened, or seared by heat, where thermo activated shade.
- c. Any garment portion puckered, twisted, or pleated at joining seam.
- d. **Shaded Parts.** Any part shaded or any shade bar.
- e. **Colour.** Any component of not specified colour.
- f. **Cleanliness.** Any slub, spot, or stain on outer side:
- (1) Threads ends not trimmed or loose threads ends not removed (to be scored only when condition exists on major portion of garment).

PAKISTAN NAVY SPECIFICATION No. XX/XY

(2) Any shade identification stamping visible on outer side.

g. **Component and Assembly.** Any component not as specified or any defect of component or defect of assembly not herein classified:

(1) Any component, component part, or required operation omitted or any other operation improperly performed not herein specified/ classified.

h. **Seams and Stitching.** Any seam twisted, puckered, or pleated (unless otherwise classified herein):

(1) Any part of Jacket and Trouser caught in unrelated operation or stitching.

(2) Any edge not properly forced out, i.e, having fold more than specified.

(3) Ends of stitching that are not caught in other seam or stitching not securely tacked.

(4) Ends of seams or stitches that are not caught in other seams or stitching secured but backstitched for distance less than specified.

(5) Thread breaks not securely overstitched

(6) Stitching tension tight resulting in breakage of stitches when normal pull is applied.

(7) Stitching per 20 mm on major portion of seam one or two stitches more or less than specified, except on labels.

(8) Stitches per 20 mm on major portion of seam more than three stitches more or less than specified, except on labels.

(9) Any bar tacks omitted, loose, misplaced or not serving intended purpose.

(10) Three or more bar tacks missing, loose, misplaced, or not serving intended purpose on multiple pencil compartment pockets.

(11) Skipped or broken stitches on one sewn eyelet.

(12) Skipped or broken stitches in two or more sewn eyelets

(13) Stitch tension loose resulting in loose seam.

(14) Stitches in sewn eyelet one or two stitches less than specified.

PAKISTAN NAVY SPECIFICATION No. XX/XY

ANNEX F TO
PN SPECIFICATION NO XX/XY
PROMULGATION DATE

ACCEPTABLE QUALITY LEVELS (AQLs)

1. Acceptable Quality Level (AQL) is maximum average defective items in a lot or limit / percentage of defective items in product /offered store. It is expressed in a percentage. Number of average defective items is determined by following formula:

$$\text{Average defective item} = \frac{\text{No.of defective item found during inspection}}{\text{Total no.of item to be inspected}} \times 100$$

2. AQL process: it is used for inspection of finished product / garment by the QC professionals. AQL standard is depend on the quality of the product to be inspected, random sampling, and experience of inspector. Normally lower figure AQL standard e.g. 01% is used for high quality products/ narrow width fabric and high figure AQL standard e.g. 10% for low quality product/ garment. AQL standard 2.5% means that allowable limit of defective item is 2.5 % of total items inspected .Usually AQL 2.5% is used for major defects, AQL 4.0 % is used for minor defects and AQL 6.5% is used for slight defects, however zero acceptance for critical defects Allowable limit of Major defects are less than minor defects and it depends upon nature of item /offered store. It can be less than 01% or greater than 10%. .Following AQL table is used to determine lot size/ offered store quantity, least No. of sample to be inspected, AQL %, and acceptance & rejection points:

<u>SINGLE SAMPLING PLAN FOR NORMAL INSPECTION OR AS PER ORDER OF INSPECTING OFFICER.</u>											
Lot size	Least No. of sample to be Inspected	Allowable Quality levels(AQL) %									
		<ul style="list-style-type: none"> • Acceptable/ Allowable defective sample (Ac) • Rejected /Exceed allowable limit of defective item (Re) 									
		1.5%		2.5%		04%		6.5%		10%	
		Ac	Re	Ac	Re	Ac	Re	Ac	Re	Ac	Re
281-500	20-80	1-3	2-4	1-5	2-6	2-7	3-8	3-10	4-11	5-14	6-15
501-1200	32-125	1-5	2-6	2-7	3-8	3-10	4-11	5-14	6-15	7-21	8-22
1201-3200	50-200	2-7	3-8	3-10	4-11	5-14	6-15	7-21	8-22	10-21	11-22
3201-10000	80-315	3-10	4-11	5-14	6-15	7-21	8-22	10-21	11-22	14-21	15-22
10001-35000	125-500	5-14	6-15	7-21	8-22	10-21	11-22	14-21	15-22	21	22
35001-150000	200-800	7-21	8-22	10-21	11-22	14-21	15-22	21	22	21	22

PAKISTAN NAVY SPECIFICATION No. XX/XY

150001-500000	315-1250	10-21	11-22	14-21	15-22	21	22	21	22	21	22
500001-above	500-2000	14-21	15-22	21	22	21	22	21	22	21	22

3. If the inspector have time constrain then AQL is beneficial/ helpful in inspection of whole lot/ offered store. It safe time, cost and give effective/ statistical result of product /offered store e.g. If inspector needs 5 minutes to check the item , the quantity to be inspected is 2,500 items then it took 208 hours to check the whole consignment/ offered store.it means 26 days approx. for one store. Calculation is as follows:

$$\frac{5 \text{ min} \times 1 \text{ hr}}{1 \text{ item} \times 60 \text{ min}} \times 2,500 \text{ items} = 208.33 \text{ hrs} \cong 26 \text{ days}$$

After Implementing AQL standard so the sample taken from the lot/ offered store is 200 items/ sample:

$$\frac{5 \text{ min} \times 1 \text{ hr}}{1 \text{ item} \times 60 \text{ min}} \times 2,00 \text{ items} = 16.66 \text{ hrs} \cong 02 \text{ days}$$

4. Quality parameters/ AQL limits may be defined by Inspecting Authority (if deemed appropriate) and communicate to the manufacturer, so the manufacturer set their quality levels (AQL limits) accordingly for their internal audit. Therefore, good quality product is ready for inspection.

PAKISTAN NAVY SPECIFICATION No. XX/XY

ANNEX G TO
PN SPECIFICATION NO XX/XY
PROMULGATION DATE

FEEDBACK FORM

Unit Name: _____

Item Description#: _____

Issue/Problem occurred: _____

PN SPEC #: _____

Possibility to resolve Issue: _____

Any Other Remarks: _____

Note:

- It's good to give feedback for improvement in any clothing Item.
- Recurring problem will also be intimated through this form.

Name Stamp

COUNTERSIGNED By CO/Admin Authority

Name Stamp

PAKISTAN NAVY SPECIFICATION No. XX/XY

Blank Page

Capr PN Muhammad Yousuf (OCL-S) 21 May 26, 1146 hrs

GENERAL REQUIREMENTS/CONDITIONS**ANNEX 'B' TO**

Indent No 525052

Indent Date. 2026-05-15 00:00:

<u>S.No and Description</u>	<u>Firm's Reply (Complied)/ Partially Complied/ Not Complied</u>	<u>Reference to attached Firm's proposal/ Brochure</u>
<p>1. SCOPE OF SUPPLY/ WORK</p> <p>The Supplier undertakes to deliver equipment/goods/stores including Supplies and Services to the Purchaser on FOR/ FOB Karachi basis as per INCOTERMS 2020 as per details specified in Annex-A (Technical Specifications) and General Terms and Conditions given at Annex-B to this Indent.</p> <p>The Supplier shall, in accordance with the terms and conditions as set forth in the Indent, with due care and diligence, provide the equipment/goods/stores and supply the Services within the date(s) specified in the Project Time Schedule.</p>		
<p>2. PERFORMANCE BANK GUARANTEE (PBG)</p> <p>To ensure timely and correct supply of stores, the Supplier shall furnish an unconditional and irrevocable PBG within 30 days of contract signing from a scheduled Pakistani Bank for an amount equivalent to 10% of the contract value (on a Judicial Stamp Paper of the value of Rs.100.00), in the same currency as that of the Contract and endorsed in the favour of CMA(DP) Rawalpindi. The CMA(DP), Rawalpindi has the like power of seeking encashment of the PBG as if the same has been demanded by the Purchaser himself. This PBG shall remain valid for 60 days beyond the completion of warranty period.</p> <p>If the Supplier fails to issue the Bank Guarantee within the specified period because of circumstances that the Supplier is responsible for, the Purchaser reserves the right of cancelling the Contract.</p> <p>In the event of any material breach of terms of Contract having implication on Time schedule and Scope of Work beyond the acceptable limits defined in this Contract, the Supplier shall be given a written notification to satisfy the breach within 30 days and if the Supplier fails to take satisfactory remedial actions, Purchaser shall have the right to forfeit the PBG but only to the extent of Purchaser's loss or damage resulting from such material breach. For this purpose, the Supplier undertakes not to hinder/restrain encashment of PBG provided to the Purchaser on account of this contract through any Court, extra judicial or any other process including administrative in nature whatsoever.</p>		
<p>3. PRICES OF THE ITEMS</p> <p>The Supplier should mention the price of all deliverables (i.e. Equipment/ Services, Spares, Documentation, Test Bench/ Tools/ Test Equipment, Trainings, FATs (Factory Acceptance Trials), Installation/ Integration, Acceptance Test/ Trials/ Commissioning etc where applicable) separately in financial quote. The same are to be</p>		

<p>subsequently incorporated in the contract document.</p> <p>4. TRANSFER OF TITLE AND RISK</p> <p>Risk of loss and damage to the Equipment shall be transferred to the PURCHASER according to the „INCOTERM 2020 used in the Contract and stated in Article 1.</p> <p>Title to the Equipment shall be transferred to the Purchaser when the Supplier has received full payment of the Contract Price.</p>		
<p>5. WARRANTY/ GUARANTEE</p> <p>a. Warranty period of all items except defective/non-operational shall commence from the date of acceptance of Goods/ Equipment, whereas warranty of defective/non-operational equipment (at the time of commissioning/ acceptance) shall commence after defect rectification of equipment.</p> <p>b. The stores and all its associated accessories should be warranted against DPL-15 by the Supplier for a period of 01 year, for all defects in hardware from the date of final acceptance by PN. Software provided with the systems should also have warranty for a minimum period of 05 years for any bugs found in operations. The Supplier shall provide/incorporate all software updates in this period.</p> <p>c. The Supplier should provide guarantee that the article supplied are of latest version and all modifications/up gradation have been incorporated in the equipment being supplied.</p> <p>d. The Supplier should provide guarantee that the stores produced are of current production and brand new, in accordance with approved drawing, and in all respects. The materials used, whether or not of his manufacture should also be in accordance with the latest appropriate standard specifications.</p> <p>e. The Supplier shall provide guarantee for through life supportability of the equipment and software for at least 05 years after acceptance of the entire system.</p>		
<p>6. NON DISCLOSURE AGREEMENT</p> <p>Any information about the sale/ purchase/ services/ drawings/ infrastructure etc of the project under the contract shall not be communicated to any person, other than the manufacturer/ provider of the stores/ drawings/ machinery/ equipment/ tools etc or to any press or agency not authorized by the Purchaser to receive it. Any breach on this account shall be punished under the Official Secret Act 1923.</p> <p>Promotional rights for publication of the projects are the sole responsibility of the Purchaser, and any use by the consultant shall be subject, in all instances, to the Purchaser's prior written approval.</p>		
<p>7. INSPECTION OF STORES/ ACCEPTANCE TEST</p>		

<p>PROCEDURE</p> <p>The stores shall be accepted and inspected by following officers/ Reps:</p> <p>(1) Rep of CINS</p> <p>b. Above team shall inspect and test the goods to on Supplier their conformity to the contract specifications.</p> <p>c. The conditions of the contract and technical specifications shall specify inspections/ tests criteria as required by the Purchaser and place of conduct.</p> <p>d. Purchaser shall notify the Supplier in writing of the identity to any representatives entrusted for this purpose.</p> <p>e. If any inspected or tested goods fail to conform to the specifications, Purchaser may reject them and the Supplier shall either replace the rejected goods or make alterations necessary to meet specification requirements free of cost to Purchaser.</p> <p>f. Purchaser's right to inspect, test and where necessary, reject the goods after arrival in Pakistan shall in no way be limited or waived by reasons of the goods having previously been inspected, tested and passed by Purchaser or its representative prior to the goods shipment from the country of origin.</p>		
<p>8. DISCREPANCY</p> <p>The Supplier shall render a discrepancy report to all concerned within 30 days after receipt of stores for discrepancies found in the consignment. The quantities found short or defective are to be made by the Supplier, without any additional cost on "DDP "consignee's warehouse "within 30 days.</p>		
<p>9. COMPENSATION ON BREACH OF CONTRACT</p> <p>If the Supplier fails to supply of contracted stores or contract is cancelled either on RE or without RE or contract become ineffective due to default of Supplier/ Supplier or stores/ equipment declared defective and caused loss to the Government, Supplier shall be liable to pay to the Government compensation for loss or inconvenience resulting for his default or from the rescission of his contract when such default or rescission take place such compensation shall be in excess to the RE amount, if imposed by the competent authority. Compensation amount in terms of money shall be decided by the purchase officer and shall be deposited by Supplier/ Supplier in Government treasury in the currency of contract.</p>		
<p>10. PENALTY</p> <p>a. The Supplier before making the shipment shall carry out complete test of the equipment at its facilities to ensure that the same has been manufactured as per specifications.</p>		

<p>In case the equipment does not pass the test/ trials, Purchaser has the right to outright reject the equipment or impose penalty at the rate of 10 - 15% of the value of the relevant equipment/ items.</p> <p>b. The penalty shall not absolve the Supplier to undertake the repairs in Pakistan or abroad at his cost and expense including freight charges. This shall be in addition to the penalties and obligations covered in the contract like warranty/ guarantee obligations on Form DPL-15.</p>		
<p>11. CONTRACT COMPLETION CERTIFICATES</p> <p>Upon completion of all contractual obligations under this Contract, the Supplier shall submit a "No Demand Certificate" to the Purchaser stating that no stores/ goods, Supplies, Services and payments are outstanding. Concurrently, the Purchaser shall certify through a "No Objection Certificate" that the requirement placed by the Purchaser as per terms and conditions set forth in this Contract has been fulfilled. Specimen of Contract Completion Certificate/ No Demand Certificate shall be added in the contract prior contract signing. Upon receipt of both certificates, Bank Guarantee(s) shall be returned by CMA(DP) to the Purchaser for onward return to the Supplier.</p>		
<p>12. COMPLIANCE WITH INTERNATIONAL STANDARDS</p> <p>The Goods/Equipment shall comply with all relevant ISO standards stipulated in the Contract and valid on the date of signature of the Contract. The Parties agree that any variation of any ISO standard after signature of the Contract is deemed explicitly not to be a circumstance within the responsibility of the Supplier. Implementation of any variations to the relevant ISO standards for the purpose of operating the Equipment shall be agreed between the Parties within the contractual change management procedure, prior to realization.</p>		
<p>13. TECHNICAL SCRUTINY</p> <p>Technical scrutiny of quotations forwarded by the bidder shall be carried out by a committee nominated by CO PNCSD as per instructions of NHQs. The TSR committee may ask the Suppliers to demonstrate their equipment or give a presentation for clarification. TSR committee may also visit the OEM premises at the invitation/expense of the Supplier to evaluate the manufacturing/system"s capabilities of the OEM.</p>		
<p>14. DELAYS AND LIQUIDATED DAMAGES (LDs)</p> <p>Following Liquidated Damages shall apply for late completion of Consultancy Services as given in the Contract:</p> <p>a. Delay in the completion of all contracted stores/ deliverables up to Twenty One (21) days and for subsequent schedule/orders up to 15 days (from the original Delivery Period only) shall be regarded as "grace period" and no extension/ amendment shall be</p>		

<p>required. When LD is imposed, grace period shall be inclusive.</p> <p>b. For delays beyond the Grace period of Twenty One (21) days culpably caused by consultant, Purchaser shall have the right to impose LDs.</p> <p>LD, if imposed shall be recovered at the rate of up to 2% but not less than 1% (depending upon the merit of the case as decided by Competent Purchase Officer) of the value of stores supplied late per month or a part of a month for the period exceeding the original delivery period are liable to be imposed on the Supplier by the Purchaser in accordance with DPP&I-35 (Revised 2019), if the stores/ services supplied after the expiry of the delivery date without any valid reasons, subject to provision that the total LD thus imposed shall not exceed 10% of the total value excluding taxes/ duties, freight, KPT, insurance charges of the stores delivered late.</p>		
<p>15. BIDDING PROCEDURE</p> <p>This tender shall be floated on Open Tender using Single Stage Two Envelope Bidding procedure.</p>		
<p>16. LANGUAGE, MEASUREMENTS AND WORKING METHODS</p> <p>All drawings, data-files in soft media, Man-Machinery Interface (MIMI) of software and hardware, all marking and identification systems and all other documentation required to be produced or delivered to the Purchaser under the Contract shall be written, and meetings conducted, in the English language. Measurements shall be in metric units of measurement unless otherwise specified.</p>		
<p>17. INTEGRITY PACT</p> <p>Integrity Pact duly signed by the Supplier and Purchaser. The principal/Supplier must strictly adhere to the provisions of this pact and any contravention in this regard would be dealt with severely, which may include (but not limited to) Permanent blacklisting of the principal / Supplier and/or initiation of criminal proceedings against the persons / individuals involved in a court of law.</p>		
<p>18. AMENDMENT IN CONTRACT</p> <p>Amendment in the contract if required shall be processed by Purchaser upon mutual agreement of both parties i.e. Purchaser and Supplier and formally issued through amendment in the contract/corrigendum.</p>		
<p>19. FORCE MAJEURE</p> <p>The Supplier shall not be held responsible for any delay occurring in delivery of the Goods, Supplies and Services due to event of Force Majeure, such as acts of God, war, terrorist activities, floods, earthquakes, tsunamis and other such events like, Pandemics, Lock down, acts of Governments or any other authority competent in relation to any action in connection with this Contract (including delay,</p>		

refusal, denial, revocation or any other decision regarding any Export License/permit), riots, civil commotion, acts of foreign government and its agencies and disturbance directly affecting the deliveries, and events or circumstances, including, but not limited to, any action and/or inaction by or on the part of any other person or entity, on or over which the Supplier has no control. In such an event the Supplier shall inform the Purchaser within 15 (fifteen) days of the happening and within the same timeframe about the discontinuation of such circumstances/ happening in writing.

The Party initiating the Force Majeure shall provide the other Party with reasonable proof of the occurrence of any of the aforementioned aspects along with Force Majeure event and of its effects on the delivery of the Supplies or any of its obligations towards this Contract.

Once the Party initiating the Force Majeure has provided the reasonable proof of occurrence of Force Majeure event, it shall be verified by the other Party and acknowledged to be realistic. In such case the Force Majeure shall be considered to have occurred.

If the delivery of Goods, Supplies and Services to the Purchaser has been delayed by Force Majeure conditions then additional period to the extent of such delay shall be allowed to the Supplier for completion of his obligations so affected without any increase in Contract Price.

If Force Majeure is considered present for a continuous period of more than 06 (six) months or exceeding a cumulative period of 12 (twelve) months, then both Parties shall mutually decide future course of action.

20. TERMINATION OF CONTRACT

If at any time during the currency of the contract the Purchaser decides to terminate the contract for any reason whatsoever (other than for reasons of Non- Delivery) he shall have right to do so by giving the Supplier a registered notice to that effect. In that event the Purchaser shall accept delivery at the contract price and terms of such stores/goods/services which are in the actual process of manufacture that is completed and ready for delivery within thirty days after receipt by the Supplier of such notice.

In the case of remainder of the undelivered stores/goods/services the Purchaser may elect either:

- a. To have any part thereof completed and take the delivery thereof at the contract price or to cancel the remaining quantity and pay to the Supplier for the articles or sub-components or raw materials purchased by the Supplier and are in the actual process of manufacture at the price to be determined by the Purchaser. In such a case materials in the process of manufacture shall be delivered by the Supplier to the Purchaser.

<p>b. No payment shall however be made for any materials not yet in the actual process of manufacture on the date notice of cancellation is received.</p> <p>c. Should the Supplier fail to deliver goods/services in time as per quality terms of contract or fail to render Bank Guarantee within the stipulated time period or any breach of the contract the Purchaser reserves the right to terminate/cancel the contract fully or any part thereof at the risk and expense (RE) of the Supplier. If due to any reasons Purchaser fails to perform its obligations required and needed for the smooth conduct and management of the Contract, Supplier has a right to initiate legal proceedings.</p>		
<p>21. CONFIDENTIALITY</p> <p>The Supplier and the Purchaser shall keep confidential all information of the other party, whether designated as confidential or not, obtained under or in connection with the Contract and shall not divulge the same to any third party without the written consent of the other party. The provisions of this clause shall not apply to any information in the public domain otherwise than by breach of the Contract; or information obtained from a third party who is free to divulge the same.</p> <p>The Supplier and the Purchaser shall divulge confidential information only to those employees who are directly involved in the Contract or have use of equipment and/or software used in connection with the Contract and shall ensure that such employees are aware of and comply with these obligations as to confidentiality.</p> <p>The Supplier shall undertake that any information about the sale/ purchase of the stores under this contract shall not be communicated to any person, other than the manufacturer/ Supplier/company's lawyer(s), or to any press or agency not authorized by the Purchaser to receive it. Any breach on this account shall be punishable under the Official Secret Act-1923 in addition to termination of the Contract at the risk and expense of the Supplier.</p>		
<p>22. SECURE EXCHANGE OF CORRESPONDENCE</p> <p>All correspondence pertaining to contract between Supplier and PN shall be on secured media.</p>		
<p>23. ASSIGNMENT AND SUBCONTRACTING</p> <p>Neither Party shall assign any of its rights or obligations (in whole or in part) under the Contract without the prior written consent of the other Party, which shall not be unreasonably withheld.</p> <p>The Supplier shall not subcontract any part of the Contract without the written consent of the Purchaser, which shall not be unreasonably withheld.</p>		
<p>24. INTELLECTUAL PROPERTY RIGHTS</p> <p>Unless otherwise agreed in writing, all intellectual property</p>		

<p>rights arising out of this Contract shall vest in the Supplier. The Purchaser shall have a worldwide, non-exclusive, non-transferable, royalty- free license to use, and have used, that intellectual property for any purpose.</p>		
<p>25. OWNERSHIP OF CONTRACT</p> <p>In the event of a change of ownership of Supplier, the Supplier shall ensure that the legal instrument or mode by which the change of ownership takes place shall have specified provisions to the effect that:</p> <p>a. Such change of ownership shall not in any way change, alter or modify the Terms and Conditions of this Contract, and</p> <p>b. The Supplier under new ownership shall continue to be bound by the Terms and Conditions of this Contract.</p>		
<p>26. INDEMNITY</p> <p>In the framework of the implementation of this project, both Parties shall waive off any claim against each other regarding every claim for indemnity for the losses caused to their respective personnel or respective personnel of sub-contractors/agents and their properties. However, if these losses result from deliberate fault or unmistakable error or gross negligence of Supplier or his sub-contractors/agents and/or the Purchaser, the Party involved shall bear alone the burden of the damage repairs.</p>		
<p>27. CERTIFICATION REQUIREMENT</p> <p>Supplier/OEM shall confirm through OEM certificate at the time of supply/delivery of the equipment at consignee that equipment being supplied is proven equipment.</p> <p>Supplier through certificate is to confirm that he shall provide import documents at the time of delivery of stores.</p> <p>Supplier certificate for conformance of 100% indent specifications, any deviation to be clearly indicated in the offer shall be provided at the time of delivery of stores.</p> <p>OEM's "Certificate of Conformity" originating from "Principle" who is neither the OEM nor the OEM's authorized dealer/agent/ stockiest shall not be acceptable.</p>		
<p>28. COURT OF JURISDICTION</p> <p>All disputes arising in connection with this contract shall be sorted out through mutual discussions. Unsettled issues may however be dealt with under the Laws of Pakistan. The Courts at Rawalpindi shall be the Courts of Jurisdiction for any dispute relating to this contract for adjudication.</p>		
<p>29. MISCELLANEOUS</p> <p>a. The Supplier should provide the copies of standard/ specifications referred to or used for the equipment and its accessories.</p> <p>b. Stores to be accepted on DPL-15 at consignees end.</p> <p>c. Supplier shall provide a conformance certificate that item supplied conforms to relevant international standards.</p> <p>d. The Supplier should mention the price of all deliverables separately in financial quote. The same are to be subsequently incorporated in the contract document.</p>		

<p>30. CHECKING OF SUPPLIES AT CONSIGNEE'S END</p> <p>Upon arrival, Supplies shall be checked at consignee's end in the presence of the Purchaser and Supplier's representatives. If for the reasons of economy, or any other reason, the Supplier decides not to nominate his representative for such checking; an advance written notice to this effect shall be given by the Supplier to the consignee prior to or immediately on shipment of stores. In such an event, the Supplier shall clearly undertake that the decision of consignee with regard to quantities and description of the consignment shall be taken, as final and any discrepancy found shall be accordingly made up by the Supplier. In all other cases, the consignee shall inform the Supplier about arrival of consignment immediately on receipt of stores through fax. If no response from the Supplier is received within four (04) working days from initiation of letter through fax, the consignee shall have the right to proceed with the checking without Supplier's representative. Consignee's report on checking of stores shall be binding on the Supplier in such cases.</p>		
<p>31. QUALITY STANDARDS</p> <p>The equipment and accessories are manufactured and assembled in accordance with international standards. The quality standards compliance certificate is to be submitted with the offer.</p>		
<p>32. REPEAT ORDER</p> <p>Supplier shall not increase the cost of stores if additional quantity of same item is purchased in next 12 months after commissioning of the equipment. He may however decrease the cost by considering lower market trend.</p>		
<p>33. RISK PURCHASE</p> <p>In the event of failure on the part of the supplier to comply with the contractual obligations, the contract is liable to be cancelled at the risk and expense of the supplier in accordance with DPP&I-35 (Revised 2019). The Purchaser shall be entitled to receive back all advance payments made by him along with any other compensation as mutually agreed to offset the Purchaser's risk of cost escalation of meeting same requirement from elsewhere.</p>		
<p>34. PROJECT MANAGEMENT REVIEW (PMR) MEETINGS</p> <p>The Supplier's key professionals, covering the various technical disciplines shall attend, actively participate and cooperate with the Purchaser's request for meetings without any additional cost, which shall include but not limited to the following meetings:</p> <ol style="list-style-type: none"> a. Design Review Meetings. b. Progress timeline/ payment bills meetings. c. Any other meetings held in relation to the project. 		
<p>35. TENDER SAMPLE</p> <p>Tender samples are to be provided as per clause 0114 of PN Specifications under heading Tender Sample. Lab Testing Report w.r.t. PN Specification is required for TSR. If considered appropriate, tender samples will also be tested through renowned Lab.</p>		

<p>Lab testing charges are to be paid by the supplier and same are to be paid prior finalization of TSR.</p>		
<p>36. WORKMANSHIP AND MATERIALS</p> <p>a. All work to be done shall be executed in the manner set out in the Contract. Where the manner of manufacture and execution is not set out in the Contract, the work shall be executed in a proper and workmanlike manner in accordance with recognized good practice. The Supplier shall submit for approval of the purchaser, his detailed method statement(s) for the execution of such items of work as may be desired by the Purchaser. Approval of such method statement(s) shall neither relieve the Supplier of his responsibilities under the Contract nor form any basis for claiming additional costs.</p> <p>b. The Supplier shall give the Purchaser full opportunity to examine, measure and test any work onboard/ Site which is about to be covered up or put out of view. The Supplier shall give due notice to the Purchaser whenever such work is ready for examination, measurement or testing. The Purchaser shall then, unless he notifies the Supplier that he considers it unnecessary, without unreasonable delay carry out the examination, measurement or testing.</p>		
<p>37. TERMS OF PAYMENT</p> <p>100% Contract value of the stores will be paid by the CMA(DP) Rawalpindi to the Suppliers. The amount will be claimed direct from CMA(DP) Rawalpindi on production of the following documents, under a covering letter, a copy of which shall be addressed to DP(NAVY).</p> <p>a. Bill Form (DP-5 in duplicate) to be completed according to inspection.</p> <p>b. Received copy of the Inspection Note/Delivery Receipt.</p> <p>c. Supplier delivery Challan duly received by the Consignee.</p> <p>d. Copy Registration Certificate of Sales Tax Department.</p> <p>e. Part payment/Part delivery is allowed.</p>		
<p>38. Special Instructions as Annex C</p> <p>(1). Inspection/Packing/Delivery terms</p> <p>a. CO PNCSD may order 15% of contracted</p>		

quantity against DPL-15 to meet urgent/critical requirement, under intimation to CINS. the firm is required to deliver/supplies within 45 days against receipt of such order. Liquidated damages (LD) upto 2% per month are liable to be imposed on the supplier in accordance with DP-35 for late delivery of stores without any valid reason.

b. CINS may draw random samples from the stores received by PNCSD against DPL-15 to ascertain quality. after detailed laboratory analysis, suitable price reduction (PR) as authorized may be applied by CINS for minor deviation/non- conformance from stated PN Specification. In case of major deviation/non- conformance, the stores may be rejected.

(2). Inclusion of Instructions Regarding Disposal of Rejected Uniforms.

a. Contracted firm will be responsible for proper disposal of rejected clothing stores. same are to be amended/destroyed under supervision of PN authorities to prevent their misuse by terrorists/ anti-social elements.

b. In case a supplier intends to sale rejected uniform items in local market, the procurement agency will be approached for approval of sample after suitable alteration of military appearance into civilian fashion after approval, CINS will inspect the bulk stores once again clear the lot for disposal in local market.

c. The contractor/ supplier shall submit a certificate / undertaking on firm"s letter pad that the firm will be held responsible for any misuse of rejected uniforms.

(3). In case firm is unable to get approval of advance sample within 6 months from date of contract, then contract cancellation should be recommended by CINS or CSD.

(4). Marking of stores in accordance with specification NS/MISC/002/80.

(5). Firm will give two week clear notice for the inspection.

(6). Free delivery to consignee warehouses.

(7). As per NHQs instructions promulgated vide NHQ letter ST- P/9314/INS/04 dated 05 April 2006. rejection of stores supplied by contractors will be dealt as under:

- a. 1st rejection on Govt expense.
- b. 2nd rejection on supplier"s expense
- c. On 3rd rejection, contract cancellation will be recommended by CINS or CSD.

<p>(9). The purchaser will have the flexibility to extend contract up to 03 months and also can order 15% excess of the total contracted quantity, from the supplying firm at the contract price</p> <p>(10). Purchaser is not bound to lift the entire quantity of contract.</p> <p>(11). Barcode sticker to be attached on each plastic packet containing Dress No. 1 Summer Ceremonial Square Rig).</p> <p>(12). <u>Packing</u>: as per Specs.</p> <p>(13). Care Label:</p> <ul style="list-style-type: none"> a. Washing Instructions b. Drying Instructions c. Ironing Instructions d. Any prohibitions 		
<p>39. LIABILITY</p> <p>The supplier shall not be liable under any circumstances to the buyer, its officers, agent, employees, successors and / or assignees, for any special, consequential and / or incidental damage of whatsoever kind or nature, including, without limitation, any loss, cost, damage loss of revenue or profit or loss of user, incurred or suffered by the buyer or any third party arising out of or in connection with this contract. The foregoing shall not affect buyers right to claim compensation against the supplier for damages suffered by the buyer arising directly from the performance, bad performance or non-performance of the suppliers duties and / or obligations under the contract provided however that the aggregate liability of the suppliers in connection with this contract for any cause whatsoever including indemnity and risk purchase, shall not exceed hundred percent (100%) of the total price actually paid to the supplier under this contract.</p>		
<p>40. CORRUPT GIFTS COMMISSIONS</p> <p>The Supplier shall not:</p> <ul style="list-style-type: none"> a. Offer or give or agree to give to any person in the service of the Purchaser any gift or consideration of any kind as an inducement or reward for doing or forbearing to do for having done or forborne to do any act in relation to the obtaining or execution of this Contract or for showing or forbearing to show favor or disfavor to any person in relation to this Contract. b. Enter into this or any other Contract with the Purchaser in connection with which commission has been or agreed to be paid by him or on his behalf, or to his knowledge, unless before the Contract is made, particulars of any such commission and of any agreement for the payment therein have been disclosed in writing to the Purchaser. 		

41. PROJECT SCHEDULE

The Contract shall be executed in accordance with the dates in the Project Schedule. In case of delayed performance of any other dates or periods the Supplier shall strive to compensate such overruns in order to finally meet any subsequent binding dates. If by reason of any change order, or of any act or omission on the part of the Purchaser, or any event of force majeure the Supplier shall be delayed in the completion of the Contract then provided that the Supplier shall as soon as reasonably practicable have given to the Purchaser notice of his claim for an extension of time with supporting details, the Purchaser shall on receipt of such notice grant the Supplier an extension of time as may be reasonable.

42. CUSTOMS, IMPORT DUTIES, TAXES AND OTHER CHARGES

The Purchaser shall pay all applicable customs, import duties taxes and other charges due on the Equipment payable upon its importation into the country of destination.

The Supplier shall pay all taxes, assessments, duties, levies or charges levied in the country of the manufacturer of the Equipment in connection with the supply by the Supplier of Equipment and Services.

All amounts stated to be payable by Purchaser pursuant to this Contract exclude any value added tax (VAT), sales tax, service tax, taxes on turnover or similar taxes. If the supply of Equipment or Services hereunder are chargeable to any value added tax, sales tax, service tax, taxes on turnover or similar taxes inside country of destination, and such taxes are not recoverable by the Supplier then such taxes shall be paid and borne by the Purchaser.

Purchaser shall pay and bear all other taxes, assessments, duties, levies or charges by whosoever levied in the country of destination of the Equipment. If Purchaser is required by any law to make any deduction or withholding from any amount payable to Supplier under this Contract, then the sum payable in respect of which such deduction or withholding is required to be made shall be increased to the extent necessary to ensure that, after the making of such deduction or withholding, Supplier shall receive (free from any liability in respect of any such deduction or withholding) a net sum equal to the amount which it would have received had no deduction or withholding been required to have been made. Purchaser shall pay any such withholding or deduction to the relevant authority as required by law and shall promptly provide Supplier with an official receipt or certificate in respect of the payment of the withholding or deduction.

DPL-15 (WARRANTY)

FIRM'S NAME M/s _____

1. We hereby guarantee that the articles supplied under the terms of this contract are produced new in accordance with approved drawings/specification and in all respect in accordance with the terms of the contract, and the materials used whether or not of our manufacture are in accordance with the latest appropriate standard specifications, as also in accordance with the terms of complete of good workmanship throughout and that we shall replace FOR/DDP Karachi free of cost every article or part thereof use or in use shall be found defective or not within the limits and tolerance of specifications requirement or in any way not in accordance with the terms of the contract.
2. In case of our failure to replace the defective stores free of cost within a reasonable period, we shall refund the relevant cost FOR/DPP Karachi (As the case may be in currency in with received).
3. This warranty shall remain valid for 01 Year after the acceptance of stores by the end user

The signature must be the same as that on the tender/contract, or if otherwise must be shown to be the signature of a person capable of giving a guarantee on behalf of the contractor

SIGNATURE _____

DATE _____

PLACE _____

BANK GUARANTEE FOR PERFORMANCE ON
JUDICIAL STAMP PAPER OF RS. 100/- OR
AS SUITABLE TO THE AMOUNT OF BG

- (i) Contract No. _____ dated _____
(ii) Name of Firm/Contractor _____
(iii) Address of Firm/Contractor _____
(iv) Name of Guarantor _____
(v) Address of Guarantor _____
(vi) Amount of Guarantee Rs. _____
(_____)
(in words)
(vii) Date of expire of Guarantee _____

To: The President of Islamic Republic of Pakistan through the
Controller of Military Accounts (Defence Purchase) Rawalpindi.

Sir

1. Whereas your good self have entered into Contract No.

_____ dated _____
with Messers _____

(Full Name and Address)

hereinafter referred to as our customer and that one of the conditions of the Contract is the submission of unconditional Bank Guarantee by our customer to your good self for a sum of Rs. _____ Rupees/FE (as applicable) _____

2. In compliance with this stipulation of the contract, we hereby agree and undertake as under: -

a. To pay to you unconditionally on demand and/or without any reference to our Customer and amount not exceeding the sum or Rs. _____ Rupees or FE (as applicable) _____ as would be mentioned in your written Demand Notice.

b. To keep this Guarantee in force till _____.

c. That the validity of this Bank Guarantee shall be kept one clear year ahead of the original/extended delivery period or the warrantee of the stores which so ever is later in duration on receipt of information from our Customer i.e. M/s _____ or from your office. Claim, if any must be duly received by us on or before this day. Our liability under this Bank Guarantee shall cease on the closing of banking hours on the last date of the validity of this Bank Guarantee. Claim received thereafter shall not be entertained by whether you suffer a loss or not. On receipt of payment under this guarantee, this document i.e. Bank Guarantee must be clearly cancelled, discharged and returned to us.

d. That we shall inform your office regarding termination of the validity of this Bank Guarantee one clear month before the actual expiry date of this Guarantee.

e. That with the consent of our customer you may amend/alter any term/clause of the contract or add/delete any term/clause to/from this contract without making any reference to us. We do not reserve any right to receive any such amendment/alternation or addition/deletion provided such like actions do not increase our monetary liability under this Bank Guarantee which shall be limited only to Rs. _____ (Rupees _____).

f. That the Bank Guarantee herein before given shall not be affected by any change in the constitution of the Bank or Customer/Seller or Vendor.

g. That this an unconditional Bank Guarantee, which shall be encashed on sight on presentation without any reference to our Customer/Seller or Vendor.

Guarantor

Dated: _____

(Bank Seal and Signatures)

AFFIDAVIT/UNDERTAKING
(WORTH RS. 100/- ON JUDICIAL STAMP PAPER)

Mr _____ Authorized signatory/
Partner/MD of M/s _____, do hereby solemnly affirm to DGP
(Army), DP (Navy), DP (Air) and Directorate General Defence Purchase, Ministry of Defence
Production, Rawalpindi that our firm M/s _____ has applied for registration
with Director General Defence Purchase (DGDP) duly completed all the documents required by
registration section on _____ (date) i.e before signing the contract. I certify that the above
mentioned statement is correct. In case it is detected on any stage that our firm has not applied
for registration with Director General Defence Purchase or statement given above is incorrect,
our firm will be liable for disciplinary action initiated (i.e debarring, the firm do business with
other Defence Establishment and Govt Agencies). I also accept that any disciplinary action
taken will not be challenged in any Court of Law.

Station: _____
Date: _____

Signature: _____
Name: _____
Appointment in Firm: _____

ATTESTED BY OATH COMMISSIONER WITH STAMP

DP-3

Tender No R2605330670

Name of the Firm.....
DGDP Registration No.....
Mailing Address.....
Date.....
Telephone No.
Official E-Mail.....
Fax No
Mobile No of contact person.....

To:

Directorate of Procurement (Navy)
through Bahria Gate Near SNIDS
Center, CDA Market
at Naval Residential Complex
Sector E-8, Islamabad
Tele : 051-9262314
Email : adpn33@paknavy.gov.pk

Dear Sir,

1. I/We hereby offer to supply to the Director of Procurement (Navy) the stores detailed in schedule to the tender inquiry or such portion thereof as you may specify in the acceptance of tender at the prices offered against the said schedule and further agree that this offer will remain valid up to 120 day and will not be withdrawn or altered in terms of rates quoted and the conditions already stated therein or on before this date. I/we shall be bound by a communication of acceptance to be dispatched within the prescribed time.

2. I/We have understood the Instructions to Tenders and General Conditions Governing Contract in Form No. DDP&I included in the pamphlet entitled, Government of Pakistan, Ministry of Defence (Directorate General Defence Purchase) "General Conditions Governing Contracts" and have thoroughly examined the specifications/drawings and/ or patterns quoted in the schedule hereto and am/are fully aware of the nature of the stores required and my/our offer is to supply stores strictly in accordance with the requirements.

3. The following pages have been added to and form part of this tender:

- a.
- b.
- c.

YOURS FAITHFULLY,

.....
(SIGNATURE OF TENDERER)

.....
(CAPACITY IN WHICH SIGNING)

ADDRESS:.....

DATE.....

SIGNATURE OF WITNESS.....

ADDRESS.....

*Individual signing tender and/or other documents connected with a contract must specify:-

- (a) Whether signing as "Sole Proprietor" of the firm or his attorney.
- (b) Whether signing as a "Registered Active Partner" of the firm or his attorney.
- (c) Whether signing for the firm "per procuracy".
- (d) In the case of companies and firms registered under the Act, 1913 as amended up-to-date and under the Partnership Act 1932, the capacity in which signing e.g., the Director, Secretary, Manager, Partner, etc. or their attorney and produce copy of document empowering him so to sign, if called upon to do so.
- (e) Principal's proforma invoice (in original)
- (f) Earnest money
- (g) Treasury Challan Form for tender Fees as applicable

NECESSARY DATA FOR ISSUANCE OF CONTRACTS ON EARNEST MONEY

IMPORTANT

Each column must be filled in with BLOCK CAPITAL LETTERS,
incompletion shall render disqualification.

1. Name : _____
2. Father's Name : _____
3. Address (Residential) :

4. Designation in Firm :

5. CNIC : _____
(Attach Copy of CNIC)
6. NTN : _____
(Attach Copy of NTN)
7. Firm's Address :

8. Date of Establishment of Firm :

9. Firm's Registration Certificate with FBR/Chamber of Commerce/Registrar of Companies.
(Attach Copy of relevant CERTIFICATE)
10. In case PARTNERSHIP (Attach particulars at serial 1,2,3,4,5 and 6 of each partner).

(Kindly fill in the above form and forward it under your own letter head with contact details)