



**NATIONAL TELECOMMUNICATION  
CORPORATION**

**REGIONAL HEADQUARTERS (SOUTH) MALIR HALT KARACHI**

## **e-Bidding Documents**

**FOR**

**DEPLOYMENT OF GPON OFC NETWORK AT KARACHI,  
HYDERABAD AND SUJAWAL DISTRICT**

**Through EPADS ([www.eprocure.gov.pk](http://www.eprocure.gov.pk))**

**e-Tender Notice # DIR (DEV)-S/Advertisement/2025-26  
Tender No. 995-D (a)/2025-26/2**



## Table of Contents

<b>SECTION-I</b> .....	<b>4</b>
<b>1 INVITATION TO e-BIDS</b> .....	<b>4</b>
<b>2 INTRODUCTION</b> .....	<b>5</b>
<b>3 SCOPE OF WORK</b> .....	<b>5</b>
<b>4 QUALIFICATION CRITERION OF BIDDERS</b> .....	<b>5</b>
<b>5 COST OF TENDERING</b> .....	<b>7</b>
<b>6 CLARIFICATIONS OF TENDER DOCUMENTS</b> .....	<b>7</b>
<b>7 AMENDMENT OF TENDER DOCUMENTS</b> .....	<b>7</b>
<b>8 PREPARATION OF BID</b> .....	<b>7</b>
<b>9 PRICE</b> .....	<b>8</b>
<b>10 BID SECURITY</b> .....	<b>8</b>
<b>11 VALIDITY OF BIDS</b> .....	<b>9</b>
<b>12 DEADLINE FOR SUBMISSION OF BID</b> .....	<b>9</b>
<b>13 OPENING OF BID</b> .....	<b>9</b>
<b>14 RESPONSIVENESS OF BIDDERS</b> .....	<b>9</b>
<b>15 EVALUATION CRITERION FOR MOST ADVANTAGEOUS BIDDER</b> .....	<b>9</b>
<b>16 CLARIFICATIONS / CORRECTIONS OF BID</b> .....	<b>10</b>
<b>17 COMMERCIAL COMPLIANCE STATEMENT</b> .....	<b>10</b>
<b>18 VARIATION ORDER</b> .....	<b>11</b>
<b>19 AWARD CRITERIA &amp; NTC'S RIGHT</b> .....	<b>11</b>
<b>20 NOTIFICATION OF AWARD &amp; SIGNING OF CONTRACT AGREEMENT</b>	<b>11</b>
<b>SECTION-II</b> .....	<b>12</b>
<b>1 PERFORMANCE SECURITY</b> .....	<b>12</b>
<b>2 CONTRACTORS RESPONSIBILITIES</b> .....	<b>12</b>
<b>3 TRANSPORTATION / PACKING</b> .....	<b>13</b>
<b>4 TIME FOR COMPLETION</b> .....	<b>13</b>
<b>5 WARRANTY / SERVICES</b> .....	<b>13</b>
<b>6 LIQUIDATED DAMAGES</b> .....	<b>13</b>
<b>7 PROVISIONAL ACCEPTANCE TESTING</b> .....	<b>13</b>
<b>8 PAYMENT</b> .....	<b>14</b>
<b>9 FINAL ACCEPTANCE CERTIFICATE</b> .....	<b>15</b>
<b>10 DEFAULT BY CONTRACTOR</b> .....	<b>15</b>
<b>11 ARBITRATION AND GOVERNING LAW</b> .....	<b>15</b>
<b>12 FORCE MAJEURE</b> .....	<b>16</b>
<b>13 TERMINATION FOR INSOLVENCY</b> .....	<b>17</b>
<b>14 TERMINATION FOR CONVENIENCE</b> .....	<b>17</b>
<b>15 ULTIMATE CONSIGNEE</b> .....	<b>17</b>
<b>16 REPEAT ORDER</b> .....	<b>17</b>
<b>17 INTEGRITY</b> .....	<b>17</b>
<b>18 DECLARATION OF BENEFICIAL OWNERS' INFORMATION</b> .....	<b>18</b>
<b>19 PROVISION OF STORE</b> .....	<b>18</b>
<b>20 RIGHT OF WAY</b> .....	<b>18</b>
<b>21 TEMPORARY BAR/ BLACK-LISTING OF FIRM</b> .....	<b>18</b>
<b>22 COMPLIANCE STATEMENT</b> .....	<b>19</b>
<b>23 CERTIFICATE</b> .....	<b>19</b>

<b>ANNEX-A: BOQ SUMMARY</b> .....	20
<b>ANNEX-A-1: BOQ FOR LAYING OF OPTICAL DISTRIBUTION NETWORK AT CM HOUSE KARACHI</b> .....	21
<b>ANNEX-A-2: BOQ FOR LAYING OF OPTICAL DISTRIBUTION NETWORK AT SINDH SECRETARIAT KARACHI</b> .....	24
<b>ANNEX-A-3: BOQ FOR LAYING OF OPTICAL DISTRIBUTION NETWORK AT GOVERNOR HOUSE KARACHI</b> .....	27
<b>ANNEX-A-4: BOQ FOR LAYING OF OPTICAL DISTRIBUTION NETWORK AT CENTRAL PRISON KARACHI</b> .....	30
<b>ANNEX-A-5: BOQ FOR LAYING OF OPTICAL DISTRIBUTION NETWORK AT PTV STATION, KARACHI</b> .....	33
<b>ANNEX-A-6: BOQ FOR LAYING OF OPTICAL DISTRIBUTION NETWORK AT PAK CAPITAL EXCHANGE KARACHI</b> .....	36
<b>ANNEX-A-7: BOQ FOR LAYING OF OPTICAL DISTRIBUTION NETWORK AT FBR GULSHAN KARACHI</b> .....	38
<b>ANNEX-A-8: BOQ FOR LAYING OF OPTICAL DISTRIBUTION NETWORK AT HYDERABAD DIVISION</b> .....	41
<b>ANNEX-A-9: BOQ FOR LAYING OF OPTICAL DISTRIBUTION NETWORK AT SUJAWAL DISTRICT</b> .....	45
<b>ANNEX-B-1: LAYOUT DIAGRAM CM HOUSE</b> .....	49
<b>ANNEX-B-2: LAYOUT DIAGRAM SINDH SECRETARIAT (1)</b> .....	50
<b>ANNEX-B-2: LAYOUT DIAGRAM SINDH SECRETARIAT (2)</b> .....	51
<b>ANNEX-B-2: LAYOUT DIAGRAM SINDH SECRETARIAT (3)</b> .....	52
<b>ANNEX-B-2: LAYOUT DIAGRAM SINDH SECRETARIAT (4)</b> .....	53
<b>ANNEX-B-2: LAYOUT DIAGRAM SINDH SECRETARIAT (5)</b> .....	54
<b>ANNEX-B-2: LAYOUT DIAGRAM SINDH SECRETARIAT (6)</b> .....	55
<b>ANNEX-B-3: LAYOUT DIAGRAM GOVERNOR HOUSE</b> .....	56
<b>ANNEX-B-4: LAYOUT DIAGRAM CENTRAL PRISON KARACHI</b> .....	57
<b>ANNEX-B-5: LAYOUT DIAGRAM PTV, KARACHI</b> .....	58
<b>ANNEX-B-6: LAYOUT DIAGRAM PAK CAPITAL EXCHANGE, KARACHI</b> .....	59
<b>ANNEX-B-7: LAYOUT DIAGRAM FBR, GULSHAN-e-IQBAL, KARACHI</b> .....	60
<b>ANNEX-B-8: LAYOUT DIAGRAM HYDERABAD (Shahbaz Building)</b> .....	61
<b>ANNEX-B-8: LAYOUT DIAGRAM HYDERABAD (DHO)</b> .....	62
<b>ANNEX-B-8: LAYOUT DIAGRAM HYDERABAD (NBP)</b> .....	63
<b>ANNEX-B-8: LAYOUT DIAGRAM HYDERABAD (MSU HYD)</b> .....	64
<b>ANNEX-B-9: LAYOUT DIAGRAM SUJAWAL</b> .....	65
<b>ANNEX-C: COMMERCIAL COMPLIANCE STATEMENT</b> .....	66
<b>ANNEX-D: BID SECURITY FORMAT</b> .....	67
Authorized officer's Signature & Seal:_____	<b>ANNEX-E:</b>
<b>PERFORMANCE BOND FORMAT</b> .....	67
<b>ANNEX-F: DECLARATION OF BENEFICIAL OWNER INFORMATION</b> .....	69

## SECTION-I

### **INSTRUCTIONS TO THE BIDDERS**

#### 1 INVITATION TO e-BIDS

##### **Tender Notice No. Dir (Dev)-S/Advertisement/2025-26**

National Telecommunication Corporation (NTC), invites electronic bids from the Suppliers/Service Providers, registered with Income Tax and Sales Tax Department (as Active Taxpayer) along with valid PEC registration and having relevant experience for the work (as per detail below):

Tender No.	Description of Work	Last Date & Time of Bid Submission	Bid Opening Date & Time
995-D(a)/2025-26/2	Deployment of GPON OFC Network at Karachi, Hyderabad and Sujawal District	18-June-2026 (Thursday) @ 1100 Hrs	18-June-2026 (Thursday) @ 1130 Hrs

Bidding documents as per regulations, containing detailed terms and conditions, specifications and requirements etc. are available for the registered bidders on EPADS at ([www.eprocure.gov.pk](http://www.eprocure.gov.pk)).

Electronic bids must be submitted through EPADS on or before the bid closing date and time, as specified in the table. Manual bids will not be accepted. Electronic bids will be opened on the same day, at least 30 minutes after the bid closing time, as indicated in the table.

Note: Notification of the GRC constituted in terms of Rule-48 of PPRA rules, 2004 is provided on EPADS at [www.eprocure.gov.pk](http://www.eprocure.gov.pk) and on [www.ntc.net.pk](http://www.ntc.net.pk).

**Director Development (South)**  
NTC Regional Headquarters, Wireless Gate,  
Malir Halt Karachi  
**Phone:** 021-99248891  
[www.ntc.net.pk](http://www.ntc.net.pk)

## 2 INTRODUCTION

National Telecommunication Corporation (NTC) was established on 1st January 1996 through Pakistan Telecommunication (re-organization) Act 1996 Under section 5 (2) (a) of the subject Act. NTC provides Telecommunication Services to its designated customers in accordance with the rights and privileges granted to the Corporation vide Pakistan Telecommunication (re-organization) Act 1996 and the license issued by the Pakistan Telecommunication Authority (PTA). NTC is registered with Federal and all Provincial Sales Tax Authorities like Punjab Revenue Authority, Sindh Revenue Board, Baluchistan Revenue Authority and Khyber Pakhtunkhwa Revenue Authority.

## 3 SCOPE OF WORK

3.1. NTC intends to undertake “Deployment of GPON OFC Network at Karachi, Hyderabad and Sujawal District” as per BoQs Annexure “A, A-1 to A-9” and corresponding Layout Diagrams Annexure “B-1 to B-9” as under:-

- 3.1.1. The incumbent bidder is bound to offer the prices of material and services (Annexure-A-1 to A-9) as per NTC & PTCL technical specifications.
- 3.1.2. For the execution of the project, the bidder shall undertake to deliver all store and services including installation material etc. as detailed BOQs Annexure “A-1 to A-9”, which shall be necessary for a complete functioning of the project. Any fitting, accessory part, hardware and/or software, missing in the BoQs; required to operationalize the project, however its reference price is quoted by bidder for complete functioning, shall be separately charged, otherwise it will be provided free of cost.

Following items shall be required for the execution of the work, but not limited to:

- (a) Instruction to bidders
- (b) General/Special condition of Contract
- (c) Specifications
- (d) Drawing/plan
- (e) Contract Form
- (f) Format for Bid security, Bank Guarantee, Performance bonds
- (g) Price schedule for Store items
- (h) Price schedule for Services

## 4 QUALIFICATION CRITERION OF BIDDERS

This invitation for bids is open to all reputed firms in Pakistan meeting following conditions:

S#	Description	Weightage	Breakup of weightage	Documents to be provided
I	Registration with PEC in category EE07 and EE08	Mandatory	-	The valid registration to be attached with bids
ii	Registration with Tax authorities	Mandatory	-	-Do-

iii	Having at least 03 x years relevant experience of minimum 03 x Telecommunication works in Pakistan	Mandatory	-	The relevant documents to be attached
iv	Never been black listed	Mandatory	-	Declaration on stamp papers duly attested be attached with bid
v	Having established office in Pakistan	Mandatory	-	The list of offices with addresses and contact info be attached with the bids.
vi	List of employees having at least one registered Telecom/Electronics / Electrical / Computer engineer having 2 years' experience	60-80	60 Marks for One Engineer. 20 Marks for two or more Engineers.	-
vii	The detail of equipment and plants be also provided (Insulation tester, OTDR, splicing machine, route locator and other such equipment essential for execution of laying work).	30-50	Additional 20 marks will be given to the firms having additional relevant equipment/plants.	The detail may be provided
viii	The firm must be operated by Pakistani National(s)	Mandatory	-	Duly notarized affidavit on stamp paper must be provided the bidder enunciating the details of Names, CNICs of the legal owner(s) and concerned officers/officials. Documentary evidence regarding proof of ownership must be provided along with bid. The condition is not mandatory for Public Sector Organizations, however, they should provide a letter from concerned ministry enunciating that the organization is owned by Government of Pakistan.

- Non-compliance to the mandatory clauses will lead to disqualification.
- 70% marks in other than mandatory clauses is required for a firm to be qualified.

4.1 Incorporated under companies' ordinance, 1984. "Case to Case basis" (if applicable)

4.2 Never been black listed from any government organization of Pakistan and will submit certificate on legal paper to this effect.

**Note:** Bidder must submit documentary proof against Sr. 4.1 to 4.2 Fulfillment of all conditions of "Eligible criteria" is mandatory for a successful bidder to be qualified for Evaluation along with other mandatory conditions set in tender documents.

## 5 COST OF TENDERING

The bidder shall bear all costs associated with the preparation and submission of its bid and the NTC will in no case be responsible or liable for those costs, regardless of the conduct or outcome of the tendering process.

## 6 CLARIFICATIONS OF TENDER DOCUMENTS

- 6.1 A prospective bidder requiring any clarification(s) regarding technical and commercial aspects of the tender document may notify to NTC on EPADS platform only, however, in case of further clarification/understanding are required, the bidder may contact following NTC Officers:

Divisional Engineer (Dev) South	Director (Development) South
Tel: 021-99248894	Tel: 021-99248891
Email: <a href="mailto:mahfooz.rehman@ntc.org.pk">mahfooz.rehman@ntc.org.pk</a>	Email: <a href="mailto:atta.malik@ntc.org.pk">atta.malik@ntc.org.pk</a>

- 6.2 The concerned NTC officer will respond to any request for clarification on EPADS, which receives well before (approximate 05 working days or more) to the deadline for the submission of bids.

## 7 AMENDMENT OF TENDER DOCUMENTS

- 7.1 At any time prior to the deadline for submission of bids, the NTC may, for any reason, whether at its own initiative or in response to a clarification requested by a prospective bidder, modify or amend the tender documents by issuing an amendment on EPADS.
- 7.2 Any amendment thus issued shall be part of the tender documents. To afford bidders reasonable time in which to take an amendment into account in preparing their bids, the NTC may at its discretion extend the deadline for submission of bids if deemed necessary.

## 8 PREPARATION OF BID

- 8.1 Bids should be prepared considering “Single Stage - Single Envelope” procedure.
- Bid documents and all correspondence will be in English language.
  - The bid should have a covering letter on letter pad of the firm. All pages of the bid shall be initialed/signed and official seal be affixed by the person(s) authorized to sign. In addition, all the pages of the submitted bid must be numbered. Complete bid shall be scanned and uploaded on EPADS.
- 8.2 Following documents shall be furnished / submitted with the bid:
- Duly filled Bill of Quantity (BoQs) as per [Annex-A-1 to A-9](#).
  - Duly filled and signed commercial compliance statement as per [Annex-C](#).
  - Valid Tender security.
  - Documentary evidence and undertakings as per qualification criteria.

e. Company Profile

**NOTE: Every participant bidder shall submit all above mentioned documents. Non-submission of any of above documents at the time of bid opening will lead to declaration of bidder as non-responsive & non-consideration for further evaluation.**

## 9 PRICE

- 9.1 Prices should be quoted in Pak Rupees on DDP basis as per [Annex-A-1 to A-9](#).
- 9.2 The price quoted should be firm, final, and clearly written/typed without any ambiguity. Any overwriting will lead to cancellation of bid at the time of opening.
- 9.3 The quoted price should include all the applicable government taxes, custom duties, in-land transportation, & any other applicable charges.
- 9.4 It is mandatory that the rates / prices shall be entered against each item in the Bill of Quantity (BOQs) at [Annex-A-1 to A-9](#).
- 9.5 The bidder shall be deemed to have obtained all information as to all the requirements thereto which may affect the bid price.
- 9.6 Price of any or all items quoted in a currency other than PKR shall be converted into PKR and for calculation purpose conversion rate (i.e. selling) prevailing on the date of tender opening (financial part) shall be applied.

## 10 BID SECURITY

- 10.1 The bidder shall furnish tender security amounting to **Rs. 1,700,000/-** in the form of Pay Order or Deposit at Call or a Bank guarantee as per [Annex-D](#) issued by a scheduled bank of Pakistan in favor of Director Development South NTC Karachi valid for a period 28 x days beyond the bid validity date.
- 10.2 The Original Bid Security shall be delivered in person or sent by the registered mail which should reach the office of Director (Development) South, NTC RHQs, Wireless Gate, near Malir Halt. Karachi on or before **1100 Hours on June 18, 2026**. Any online bid for which original bid security does not reach before deadline of the bid shall be rejected by the NTC as non-responsive.
- 10.3 Scanned Copy of bid security shall be uploaded by the bidder on EPADS before deadline of bid submission. Any bid not accompanied by bid security shall be rejected by the NTC as non-responsive.
- 10.4 The bid securities / earnest money of the unsuccessful bidders will be returned upon award of contract to the successful bidder or on expiry of validity of tender security whichever is earlier. The bid securities of bidders, who are not in competition, can be returned earlier at NTC discretion upon receiving a request.
- 10.5 The tender security of the successful bidder will be returned when the bidder has furnished the required Performance Security being 10% of the contractual value in the shape of Irrevocable Bank Guarantee valid for 15 x months of Pay order /Demand Draft in favour of NTC and signed contract agreement on estamp paper.
- 10.6 All correspondence regarding release/extension of bid security shall be made with Director (Development) South.
- 10.7 The bid security may be forfeited:
  - a. If a bidder withdraws his bid during the period of bid validity.

- b. If the bidder does not accept the correction of their bid price.
- c. In the case of successful bidder, if bidder fails to furnish the required performance security or sign the contract agreement.
- d. If bidder does not respond timely to the clarifications called by NTC.

## 11 VALIDITY OF BIDS

Bid shall remain valid for a period of 180 days from the date of tender opening.

## 12 DEADLINE FOR SUBMISSION OF BID

- 12.1 The bid shall be uploaded in PDF format on PPRA EPADS website i.e. [www.eprocure.gov.pk](http://www.eprocure.gov.pk) on or before **1100 Hours on June 18, 2026**.
- 12.2 The bidders are required to follow procedure of EPADS and for any clarification/assistance regarding EPADS they may contact PPRA Helpline UAN: 051-111-137-237.
- 12.3 Bid received other than EPADS i.e. hard/Soft copy delivery in person or through e-mail or fax or registered mail will be not accepted by NTC.

## 13 OPENING OF BID

- 13.1 The NTC tender committee will download the bids at **1130 Hours on June 18, 2026** in the presence of bidders' representatives who choose to attend, at NTC RHQs, Wireless Gate, near Malir Halt, Karachi.
- 13.2 NTC reserves the right to reject any one or all bids prior acceptance of a bid / proposal.
- 13.3 NTC reserves the right to reject any one or all bids as per Public Procurement Rules, 2004 33(1).

## 14 RESPONSIVENESS OF BIDDERS

- 14.1 The bid is valid till required period.
- 14.2 The bid prices are firm during its validity and inclusive of all taxes, duties & freight charges etc.
- 14.3 The bidder has furnished valid tender security.
- 14.4 The bidder is qualified to tender.
- 14.5 The bid is generally in order.
- 14.6 The bidder promptly responds to queries sought by NTC.
- 14.7 The bidder has complied with the tender clauses.

**NOTE:** *"Any bidder found non-compliant in any of above mentioned conditions will be declared as non-responsive and will not be considered for further Evaluation proceedings. A bidder once declared "Non-responsive" shall not subsequently be made responsive by the NTC."*

## 15 EVALUATION CRITERION FOR MOST ADVANTAGEOUS BIDDER

- 15.1 The tender evaluation committee will evaluate and compare only the bids previously determined to be substantially responsive.
- 15.2 Evaluation will be carried out on **qualification, quality and cost basis**.
- 15.3 The **Most advantageous bidder** shall be the one fully compliant to **qualification criteria**, complaint to **quality evaluation criteria** and **highest ranked** in cost evaluation criteria as defined below:

#### 15.4 Qualification Evaluation Criteria:

In first step, the received bids shall be evaluated on qualification criteria mentioned and full compliance to the terms and conditions set out in RFT shall be evaluated as per [Annex-C](#). The bidders fully compliant to qualification criteria shall be declared as qualified. **Any firm found non-compliant in any of these conditions will be declared disqualified and will not be considered for further evaluation proceedings.**

#### 15.5 Quality Evaluation Criteria:

It will be examined in detail whether the offered/quoted solution by the bidder complies the Technical Specifications as mentioned in the BOQ. For this purpose, the bidder's data submitted with the bid will be compared with terms and conditions set forth in the tender documents; supported documents & clarification will be sought in case compliance is not evident from the literature /documents. **Any bid which does not fully comply the Technical Specifications will be declared technically disqualified and will be rejected by NTC.**

#### 15.6 Cost evaluation criteria:

Cost evaluation of the bids shall be carried out by comparison of bids evaluated prices as per bills of quantity at [Annex-A-1 to A-9](#). The bidder with lowest financial price will be declared as **highest ranked** and so on.

15.7 Any effort by a bidder to influence NTC in the tender evaluation, bid comparison or order award decision may result in the rejection of his bid.

15.8 Any minor informality or non-conformity or irregularity in the bid which does not constitute a material deviation may be waived by NTC, provided such waiver does not prejudice or affect the relative ranking of any other bidders.

### 16 CLARIFICATIONS / CORRECTIONS OF BID

16.1 To assist in the examination, evaluation and comparison of the bids the committee at its discretion may ask the bidder for a clarification of its bid. The request for clarification and the response shall be in writing (i.e. letter or email etc.) and no change in the price or substance of the bid shall be sought, offered or permitted.

16.2 Arithmetical errors will be rectified on the following basis:

“If there is a discrepancy between unit price and total price that is obtained by the multiplying the unit price and quantity, the unit price shall prevail and total price shall be corrected. If there is a discrepancy between the words and figures the amount in words shall prevail. If there is a mistake in addition / totaling that can be corrected.”

16.3 If the bidder does not accept the corrected amount of bid, their bid will be rejected and their bid security forfeited.

### 17 COMMERCIAL COMPLIANCE STATEMENT

The bidder will furnish a compliance certificate with the bid as per enclosed format as per [Annex-C](#) (duly signed along with company seal).

## 18 VARIATION ORDER

NTC reserves the right to place variation order (increase or decrease in the quantities of BoQs at [Annex-A-1 to A-9](#)). The bidder shall be bound to accept the variation order by NTC.

## 19 AWARD CRITERIA & NTC'S RIGHT

- 19.1 The contract will be awarded to Most Advantageous Bidder on as-a-whole basis.
- 19.2 The NTC reserves the right to accept or reject any bid, and to annul the tendering process and reject all bids, at any time prior to award of order, without thereby incurring any liability to the affected bidders or any obligation to inform the affected bidders of the grounds for the NTC's action.

## 20 NOTIFICATION OF AWARD & SIGNING OF CONTRACT AGREEMENT

- 20.1 Prior to expiration of the period of tender validity prescribed by NTC, the NTC will notify the successful bidder in writing "Letter of Intent" through EPADs that their bid has been accepted. The bidder shall accept the LOI through EPADS.
- 20.2 The contract shall be signed with the successful bidder upon furnishing of acceptable performance security.

## SECTION-II

### **TERMS & CONDITIONS OF CONTRACT**

#### **1 PERFORMANCE SECURITY**

- 1.1 The successful bidder shall furnish to the NTC a performance security equivalent to 10% of the contract value in the shape of Pay order or CDR or bank guarantee valid for a period of 15 months as per [Annex-E](#) after signing of contract.
- 1.2 The bank guarantee of performance security shall be further extended if the delivery is delayed. Furthermore, the contractor shall extend the bank guarantee (if required) to cover the warranty period.
- 1.3 Failure of the successful bidder to furnish performance security shall constitute sufficient grounds for the annulment of the award and forfeiture of the tender security.
- 1.4 All the correspondence regarding release of performance guarantee shall be made with Director (Development) South.
- 1.5 The Performance Security shall be released after expiry of the Maintenance / Warranty period, subject to issuance of Final Acceptance Certificate (FAC), by Director Development South NTC Karachi.

#### **2 CONTRACTORS RESPONSIBILITIES**

- 2.1 The contractor shall complete the work in accordance with the contract BoQ, Specs, Plan and responsibility matrix within the agreed completion time.
- 2.2 The contractor shall not subcontract the whole of the works. The contractor shall not subcontract any part of the works without the consent of the NTC.
- 2.3 The contract shall, in accordance with the contract, with due care and diligence, complete the works and test and commission the network/works and carry out the works within the stipulated "Time for Completion". The contractor shall provide all necessary Contractor equipment, superintendence, labors and materials necessary for accomplishment and testing of the work as per contract.
- 2.4 Regarding liaison with other Govt. Deptts./ Entities etc and acquiring NOC/Permission (involving smooth accomplishment of project), The contractor will provide the information /detail(s) of his labour within 03 x days on such requirement at his own cost. Any delay in provision of labour information will be considered on part of the contractor.
- 2.5 Upon completion of the work, the contractor shall prepare and provide as built diagrams of the network infrastructure. Such documentation shall be delivered in both:
  - a. Hard Copy Format, Printed diagrams showing the finalized network layout.
  - b. Soft Copy Format in KMZ format, accurately reflecting the coordinates and descriptive details of all installed components,

including but not limited to Handholds, FDHs, Splitters, and Fiber Access Terminals (FATs).

### 3 TRANSPORTATION / PACKING

All types of transportation for delivery of equipment at final destination will be the responsibility of the contractor. Contractor shall ensure proper / international packing of equipment/cables to avoid deterioration of equipment / cable etc. Contactor shall also be responsible for transportation of NTC or any other Department which store will be utilized in the project.

### 4 TIME FOR COMPLETION

4.1 The Contractor shall complete the whole work within **04 × Month** from the date of go-ahead by the Project Director / Ultimate Consignee.

### 5 WARRANTY / SERVICES

5.1 The contractor will warrant that the equipment supplied under the contract are new, un-used, and incorporates all recent improvements in design and materials and of good quality. The warranty shall remain valid for a period of 12 months starting from the date of issuance of PAC. NTC shall promptly notify the supplier in writing of any claims arising under this warranty and the supplier will repair / replace the defective items within reasonable time without any cost effect.

5.2 The contractor, for technical assistance at the highest level shall provide high-level support/technical assistance at sites on 24 x 7 basis, during the warranty period, free of cost.

### 6 LIQUIDATED DAMAGES

Unless the delay in completion of work is caused by force majeure and the delay is on part of the Contractor, contractor shall pay to NTC as liquidated damages a sum equivalent to 0.5% of the actual work / completion cost for each week of delay and subject to a maximum of 10% value of the delayed portion of the contract, as such the completed component is usable in all respect otherwise 10% of the total contract value shall be levied, and same will be recovered from the contractor at the time of PAC. In case of force majeure, the delivery period may be extended on receipt of request/intimation from contractor with evidence during the execution period. For the purpose of calculation of Liquidated Damages charges, 7 days of week would be considered, and goods delayed for more than 3 days will be considered as one week otherwise less than or equal or upto 3 days will not be penalized. The parties agree that the accumulated total liquidated damages for delay shall carry a maximum limit of upto 10% of the contract value.

### 7 PROVISIONAL ACCEPTANCE TESTING

- 7.1 Director Development South NTC Karachi will detail a PAT team for Provisional Acceptance Test and final inspection. The contractor will be responsible to arrange all type of test equipment, tools, labor etc. at his own cost for successful conduct of PAT/ Inspection. The PAT team shall confirm the quantities and functioning of stores, equipment, network, work etc., and will mention discrepancies (if any). Director Development South NTC Karachi will issue the PAC on the basis of successful conduct of PAT /Final inspection including verification of contract BoQ as per site requirement.
- 7.2 On “Successful Conduct of PAT”, the “Provisional Acceptance Certificate” will be issued within 15 x days.
- 7.3 If the equipment is commercially launched before the PAT/PAC, the date on which the equipment is commercially launched will be considered the date of PAC.
- 7.4 In case Provisional Acceptance Certificate is not issued within Fifteen (15) days, Director Development South NTC Karachi shall inform in-writing of the specific reason(s) for the delay within 05 days after receipt of request from the Contractors.
- 7.5 NTC reserves the rights to reject any item even after issuance of Provisional Acceptance Certificate if it does not conform to the specifications by reason of some defect, latent or otherwise of material which was not discoverable by a reasonable examination.
- 7.6 The Provisional Acceptance Certificate (PAC) will be valid for warranty period of 01 year.

## 8 PAYMENT

Payment of contract price shall be made in the following manners.

- 8.1 The execution of work by contractor shall not be conditional to payment of running bills by NTC.
- 8.2 In case NTC deemed necessary then NTC may make running payments to the contractor based on the actual work progress as follows:
  - a. In case NTC has to provide the major portion of stores, running payments upto 60% will be made, based on the progress of actual work / store consumption.
  - b. In case NTC has not to provide stores, running payments upto 70% will be made, based on the actual work progress.
- 8.3 The running payment, as per clause 8.2 above, shall be made after necessary testing/inspection, as deemed necessary by Director Development South NTC Karachi.

- 8.4 The balance payment shall be made to the contractor after issuance of PAC Director Development South NTC Karachi.
- 8.5 The performance security (10% of work completion) will be released after successful completion of warranty/defect liability period and issuance of Final Acceptance Certificate (FAC) by Director Development South NTC Karachi.
- 8.6 Taxes will be deducted as per government rules at the time of payment.
- 8.7 Payments shall only be released if the contractor is found to be “Active Tax Payer” in Federal Board of Revenue (FBR) Pakistan database at the time of payment. Contractor will provide the e-return of each invoice after payment.
- 8.8 The invoice must be clearly marked as running or final bill and shall be forwarded On the original bill book / letter head pad of the contractor and signed by the contractor or his authorized representative along with original GST invoice clearly mentioning the GST number of both the contractor and NTC (STRN: 07-01-9802-013-64 NTN: 1218153-6) on the contractor’s original letter head pad.

## **9 FINAL ACCEPTANCE CERTIFICATE**

- 9.1 The contractor may notify the NTC concerned Director at-least 15 days before the expiry of warranty period for the issuance of final acceptance certificate. Upon such notification from contractor, the NTC concerned Director will issue Final Acceptance Certificate in favour of contractor subject to satisfactory completion of warranty period as per requirement of contract. Alternatively the NTC concerned Director will notify the contractor for the discrepancies that still remain un-resolved and contractor will rectify the discrepancies.
- 9.2 On issuance of Final Acceptance Certificate, contractor shall request for release of bank guarantee submitted as performance security.

## **10 DEFAULT BY CONTRACTOR**

- 10.1 If the contractor fails to supply the equipment, refuses or fails to comply with a valid instruction of the NTC, the NTC may give notice and stating the default.
- 10.2 If the contractor has not taken all practicable steps to remedy the default within 14 working days after receipt of NTC notice, the NTC may by a second notice cancel the contract and performance security will be confiscated.

## **11 ARBITRATION AND GOVERNING LAW**

- 11.1 This Agreement shall be governed under Pakistani law and the Courts at Karachi shall have exclusive jurisdiction over any matter that may be referred to a Court under this Agreement.

- 11.2 In the event that any dispute arises between the Parties under this Agreement, one Party shall issue notice to the other Party to mutually negotiate a resolution to the dispute. If the negotiations fail to resolve the dispute within seven (07) days of receipt of the notice, the dispute shall be referred to the Managing Director, National Telecommunication Corporation (“MD”) or his nominee who shall provide a personal hearing to Contractor and render a decision thereon within a period of thirty (30) days. In the personal hearing conducted pursuant to this clause, the Contractor shall not be represented by a legal practitioner within the meaning of the legal Practitioners and Bar Councils Act, 1973.
- 11.3 If the Contractor is aggrieved of the decision of the MD or his nominee rendered under clause (11.2) hereof, the Contractor may refer the dispute to arbitration within thirty (30) days of the date of the decision of the MD or his nominee under the Arbitration Act, 1940 or any law that the Arbitration Act, 1940 is repealed, amended, or modified by at the time of referral of the dispute to arbitration. The arbitration shall be conducted before a Sole Arbitrator to be appointed by the consent of the Parties. The seat and venue of arbitration shall be at the National Telecommunication Corporation Headquarter, Sector G-5/2, Islamabad. The arbitration and the award thereof shall be conducted in the English language.
- 11.4 The costs and fees of the Sole Arbitrator shall be shared by the Parties equally. A Party shall bear the costs and fees of its legal practitioners and other personnel that a Party engages for the arbitration unless otherwise awarded by the Sole Arbitrator.

## 12 FORCE MAJEURE

- 12.1 The Contractor shall not be liable for forfeiture of its performance security, liquidated damages or termination for default, if and to the extent that, its delay in performance or other failure to perform its obligations under the contract is the result of an event of Force Majeure.
- 12.2 If either party is temporarily rendered unable, wholly or in part by Force Majeure to perform its duties or accept performance by the other party under the Contract it is agreed that on such party, giving notice with full particulars in writing of such Force majeure to the other party within 14 (fourteen) days after the occurrence of the cause relied on, then the duties, of such party as far as they are affected by such Force Majeure shall be suspended during the continuance of any inability so caused but for no longer period and such cause shall as far as possible be removed with all reasonable speed. Neither party shall be responsible for delay caused by Force Majeure.
- 12.3 The terms “Force Majeure” as used herein shall mean Acts of God, strikes, lockouts or other industrial disturbance, act of public enemy, war, blockages, insurrections, riots, epidemics, landslides, earthquakes, fires, storms, lightning, flood, washouts, civil disturbances, explosion, Governmental Export/Import Restrictions (to be supported by a letter from the relevant Authority and verified by the Diplomatic Mission in Pakistan), Government actions/restrictions due to economic and financial hardships, change of priorities and any other cause similar to the kind herein enumerated or of

equivalent effect, not within the control of either party and which by the exercise of due care and diligence either party is unable to overcome.

- 12.4 The term of this Contract shall be extended for such period of time as may be necessary to complete the work which might have been accomplished but for such suspension. If either party is permanently prevented wholly or in part by Force Majeure for period exceeding 12 (twelve) months from performing or accepting performance, the party concerned shall have the right to terminate this contract immediately giving notice with full particulars for such Force Majeure in writing to the other party, and in such event, the other party shall be entitled to compensation for an amount to be fixed by negotiations and mutual agreement.
- 12.5 If a Force Majeure situation arises, the Contractor shall promptly notify NTC in writing of such conditions and the cause thereof. Unless otherwise directed by NTC in writing, the supplier shall continue to perform its obligations under the contract as far as is reasonably practicable, and shall seek all reasonable alternative means for performance not prevented by the Force Majeure event.

### **13 TERMINATION FOR INSOLVENCY**

The NTC may at any time terminate the contract by giving written notice to the bidder, without any compensation to bidder. If the bidder becomes bankrupt or otherwise insolvent, provided that such termination will not prejudice or affect any right of action or remedy which has accrued or will accrue thereafter to action to the NTC.

### **14 TERMINATION FOR CONVENIENCE**

Without prejudice to the contractor, the NTC may send a written notice to the bidder, terminate the contract in whole or in part any time for its convenience. The notice of termination shall specify that the termination is for the NTC's convenience, the extent to which performance or work under the contract is terminated and the date upon which such termination becomes effective.

### **15 ULTIMATE CONSIGNEE**

Director Development South NTC Karachi being Project Director (PD) would execute the work(s) as per contract.

### **16 REPEAT ORDER**

NTC may place Repeat Order on the contractor as per PPRA Rules 2004.

### **17 INTEGRITY**

- 17.1 The Contractor hereby declares that it has not obtained or induced the procurement of this Contract or a right, interest, privilege or other obligation or benefit under this Contract from Government of Pakistan or any administrative subdivision or agency thereof or any other owned or controlled by it (GoP) through any corrupt business practice.

- 17.2 Without limiting the generality of the foregoing the Contractor represents and warrants that it has fully declared the brokerage, commission, fees etc., paid or payable to anyone and not given or agreed to give and shall not give or agree to give to anyone within or outside Pakistan either directly or indirectly through any natural or juridical person, any commission, gratification, bribe, finder's fee or kickback, whether described as consultation fee or otherwise, with the object of obtaining or including the procurement of this Contract or a right, interest, privilege or other obligation or benefit under this Contract in whatsoever form from GoP, except that which has been expressly declared pursuant hereto.
- 17.3 The Contractor accepts full responsibility and strict liability for making any false declaration, not making full disclosure, misrepresenting facts or taking any action likely to defeat the purpose of this clause.

## 18 DECLARATION OF BENEFICIAL OWNERS' INFORMATION

- 18.1 The "Declaration of Beneficial Owners' Information of Public Procurement Contract Awarded Regulations, 2022" require that the contractor shall be bound to provide beneficial ownership information as per Performa attached as [Annex-F](#).

## 19 PROVISION OF STORE

- 19.1 The stores will be provided by the Contractor as per BoQs (i.e. Annex-A1- A-9).
- 19.2 NTC will provide the store as prescribed in the BoQ under NTC Store.

## 20 RIGHT OF WAY

Contractor will be sole responsible for all types of permissions and right of way.

## 21 TEMPORARY BAR/ BLACK-LISTING OF FIRM

- 21.1 As per clause-19 of the PPRA Rules 2004, NTC reserves the right of debarment 'or' blacklisting of a firm, association, corporation, joint venture, company, partnership or any other legal entity subject to any of the following acts:-
- Consistent failure to provide satisfactory performance.
  - Contractor becomes insolvent.
  - Existence of judicial decision against a contractor in respect of a corrupt or collusive practice.
  - Submission of false and spurious documents, making false statements and allegations to gain undue advantage.
  - Commission of fraud.
  - Contractor abandons the contract.
  - Contractor without reasonable excuse fails to commence the work 'or' suspends the progress of work for 14 days.

- h. Contractor is not executing the work in accordance with the contract or is persistently or flagrantly neglecting to carry out his obligations under the contract.
  - i. Commission of embezzlement, criminal breach of trust, theft, cheating, forgery, bribery, falsification or destruction of records, receiving stolen property, false use of trademark, securing fraudulent registration with sales tax authorities, Pakistan Engineering council etc., giving false evidence, furnishing of false information of serious nature.
- 21.2 Managing Director NTC will constitute a committee comprising of three NTC officers and they will investigate the matter in connection with allegation of corrupt, fraudulent, coercive or collusive practices or illegally harassment or threat. Moreover, the committee shall also accord adequate opportunity of being heard to the contractor who is to be debarred / blacklisted. The said committee will forward its clear recommendations for the approval of Chairman / Managing Director NTC.
- 21.3 The debarment shall be for a reasonable specified period of time, commensurate with the seriousness of the cause. However, the debarment period shall not exceed from three years. Moreover, NTC also reserves the right of permanent blacklisting of a contractor subject to severity of the corrupt or fraudulent practices.

## 22 COMPLIANCE STATEMENT

Bidders will sign the attached compliance statement / certificate that he will abide by all commercial as well as technical instructions of the Terms and Conditions with the bid documents.

## 23 CERTIFICATE

I do hereby certify on behalf of my firm that:

- a. I have understood and hereby accept all the terms and conditions as mentioned in the tender documents and I will abide by the instructions issued by NTC.
- b. I am not involved in any litigation/court of law with NTC or any other Government organizations.
- c. The equipment/Items to be supplied under the contract shall be new and as standard / specifications.

Contractor,

Name: \_\_\_\_\_

Signature: \_\_\_\_\_

Date: \_\_\_\_\_

## ANNEX-A: BOQ SUMMARY

Cost Summary of Optical Fiber Network				
S/No.	Name of Site	Cost of Contractors Stores	Cost of Contractors Services	Total Amount (PKR)
1	Sindh Secretariat (Annex-A1)			
2	Governor House (Annex-A2)			
3	Chief Minister House (Annex-A3)			
4	Central Prison (Annex-A4)			
5	PTV (Annex-A5)			
6	Pak Capital Exchange (Annex-A6)			
7	FBR Gulshan (Annex-A7)			
8	Hyderabad (DHO, NBP, Shahbaz Building, & MSU) (Annex-A8)			
9	Sujawal (Annex-A9)			
<b>Grand Total (PKR)</b>				

**GRAND TOTAL (Stores + Services):** \_\_\_\_\_

**Amount in Words:** \_\_\_\_\_

**ANNEX-A-1: BOQ FOR LAYING OF OPTICAL DISTRIBUTION NETWORK AT  
CM HOUSE KARACHI**

<b>NTC Store</b>						
<b>Sr. #</b>	<b>Description</b>	<b>A/U</b>	<b>Qty</b>	<b>Unit Price without (18% GST) Taxes</b>	<b>Unit Price with (18% GST) Taxes</b>	<b>Total Price with Taxes</b>
1	Optical Fiber Cable 48 Fibers (duct buried, Single mode G.652)	Mtr	725	To be Provided by NTC		
2	Optical Fiber Cable 24 Fibers (duct buried, Single mode G.652)	Mtr	310			
3	Aerial Optical Fiber Cable 6 Fibers (Single Mode, G.652)	Mtr	1,770			
4	2 Fiber Drop Fiber (Single mode)	Mtr	14,400			
5	Joint Enclosure 24 Fiber Complete With all respect	No	3			
6	Joint Enclosure 12 Fiber Complete With all respect	No	1			
<b>A. STORE</b>						
<b>Sr. #</b>	<b>Description</b>	<b>A/U</b>	<b>Qty</b>	<b>Unit Price without (18% GST) Taxes</b>	<b>Unit Price with (18% GST) Taxes</b>	<b>Total Price with Taxes</b>
1	FDH Wall Mount (Weatherproof – IP65 or higher, Metal Enclosure) – 24F ODF, Preloaded with SC/APC Adapters & Pigtails, Splice Trays, Cable Management Accessories, and Splitter Mounting Slots	No	1			
2	19" Rack floor Standing for ODF along with all installation material	No	1			
3	Rack mount ODF of <b>48 Ports</b> Pre-Loaded along with SC/APC adopter Pigtails Splice Tray complete etc	No	3			
4	Rack mount ODF of <b>24 Ports</b> Pre-Loaded along with SC/APC adopter Pigtails Splice Tray	No	2			

	complete etc.					
5	Rack mount ODF of <b>12 Ports</b> Pre-Loaded along with SC/APC adopter Pigtailed Splice Tray complete etc.	No	2			
6	FDH/Rack Splitter 1:2 with Pre-Loaded SC/APC Adopter loaded in Tray etc.	No	4			
7	FDH/Rack Splitter 1:4 with Pre-Loaded SC/APC Adopter loaded in Tray etc.	No	3			
8	FAT 16x ports pre-loaded along with SC/APC Adopter (single mode), Splitter, Pigtail Splice tray & loss within 10 dbm etc.	No	8			
9	FAT 8x ports pre-loaded along with SC/APC Adopter (single mode), Splitter, Pigtail Splice tray & loss within 10 dbm etc.	No	12			
10	Pigtail 1m (single mode) with SC/APC adapter for drop fiber termination to FAT/patch panel	No	144			
11	Patch Cord SC/APC (Single mode) 3 meter for FDH/Rack Mount ODF	No	108			
12	Patch Cord (Single mode) 10 meter for OLT side	No	8			
13	Access Termination Box (ATB)- OFDF 2-Fiber pre-loaded accessories SC/SC, FC/LC, FC/PC, FC/SC with AC/APC adapters & pigtailed	No	144			
14	Field Installable Connector with Mechanical Splice and SC Adapter for drop wire termination	No	144			
15	PVC /channel patti 1"/Flexible Pipe 1" dia.	Mtr	500			
16	PVC /channel patti 2"/Flexible Pipe 2" dia.	Mtr	200			
17	Angle-Iron Brackets, Clamps, Insulators, Shingles & all Accessories for support & hanging of SSA OFC Cables on poles, buildings etc.	Set	12			
18	Wall Mount Hanging Clamp for Drop Fiber fixing	Box	20			
<b>Sub Total (A) Rs.</b>						

<b>B. SERVICES</b>						
<b>Sr.#</b>	<b>Description</b>	<b>A/U</b>	<b>Qty</b>	<b>Unit Price without (15% SST) Taxes</b>	<b>Unit Price with (15% SST) Taxes</b>	<b>Total Price with Taxes</b>
1	Pulling/fixing/hanging of OFC on wall/pole/roof/ building etc. (length of route will be measured on ground)	Mtr	2,805			
2	Fixing of Drop Fiber through conceal	Mtr	14,400			
3	Fixing of Angle-Iron Brackets, Clamps, Insulators, Shingles & all Accessories for support & hanging of SSA OFC Cables on poles, buildings etc.	Job	12			
4	Splicing/Jointing of OFC in FDH /FAT/Joint enclosure	No	216			
5	Installation/fitting of 19" Rack along with support/ installation material etc.	No	1			
6	Installation and Fixing of FATs, ODFs, ATBs on walls, or in Rack or in FDH including required accessories etc	No	170			
7	Installation of FDH on Wall	No	1			
8	Transportation of NTC Stores from warehouse to Site	Job	1			
<b>Sub Total (B) Rs.</b>						
<b>Grand Total (A+B) Rs.</b>						

**ANNEX-A-2: BOQ FOR LAYING OF OPTICAL DISTRIBUTION NETWORK AT  
SINDH SECRETARIAT KARACHI**

<b>NTC Store</b>						
<b>Sr. #</b>	<b>Description</b>	<b>A/U</b>	<b>Qty</b>	<b>Unit Price without (18% GST) Taxes</b>	<b>Unit Price with (18% GST) Taxes</b>	<b>Total Price with Taxes</b>
1	Optical Fiber Cable 96 Fibers (duct buried, Single mode G.652)	Mtr	625			To be provided by NTC
2	Optical Fiber Cable 48 Fibers (duct buried, Single mode G.652)	Mtr	400			
3	Optical Fiber Cable 24 Fibers (duct buried, Single mode G.652)	Mtr	400			
4	Aerial Optical Fiber Cable 12 Fibers (Single Mode, G.652D)	Mtr	230			
5	Aerial Optical Fiber Cable 6 Fibers (Single Mode, G.652D)	Mtr	7,468			
6	2 Fiber Drop Fiber (Single mode)	Mtr	68,595			
7	Joint Enclosure 96 Fiber Complete With all respect	No	11			
8	Joint Enclosure 12 Fiber Complete With all respect	No	2			

<b>A. STORE</b>						
<b>Sr. #</b>	<b>Description</b>	<b>A/U</b>	<b>Qty</b>	<b>Unit Price without (18% GST) Taxes</b>	<b>Unit Price with (18% GST) Taxes</b>	<b>Total Price with Taxes</b>
1	FDH Cabinet (Weatherproof – IP65 or higher, Metal Enclosure) – <b>192F</b> ODF, fully preloaded with SC/APC Adapters & Pigtails, Splice Trays, Cable Management Accessories, and Splitter Mounting Slots. (Indoor/Outdoor)	No	1			
2	19" Rack floor Standing for ODF along with all installation material	No	3			
3	Rack mount ODF of <b>288 Ports</b> Pre-Loaded along with SC/APC adopter Pigtails Splice Tray complete etc.	No	2			
4	Rack mount ODF of <b>96 Ports</b> Pre-Loaded along with SC/APC adopter Pigtails Splice Tray complete etc.	No	1			
5	FDH Splitter 1:2 with Pre-Loaded SC/APC Adopter loaded in Tray etc.	No	31			

6	PLC Splitter 1:2, wall mount with splitter box and SC/APC adopters	No	4			
7	FDH Splitter 1:4 with pre-loaded SC/APC Adopter loaded in Tray etc.	No	3			
8	FAT 32x ports pre-loaded along with SC/APC Adopter (single mode), Splitter, Pigtail Splice tray & loss within 10 dbm etc.	No	6			
9	FAT 16x ports pre-loaded along with SC/APC Adopter (single mode), Splitter, Pigtail Splice tray & loss within 10 dbm etc.	No	70			
10	FAT 8x ports pre-loaded along with SC/APC Adopter (single mode), Splitter, Pigtail Splice tray & loss within 10 dbm etc.	No	12			
11	Pigtail 1m (single mode) with SC/APC adapter for drop fiber termination to FAT/patch panel	No	1,007			
12	Patch Cord SC/APC (Single mode) 3 meter for FDH/Rack Mount ODF	No	142			
13	Patch Cord (Single mode) 10 meter for OLT side	No	48			
14	Access Termination Box (ATB)-OFDF 2-Fiber pre-loaded accessories SC/SC, FC/LC, FC/PC, FC/SC with adapters & pigtails	No	1,007			
15	Field Installable Connector with Mechanical Splice and SC Adapter for drop wire termination	No	1,007			
16	HDPE Pipe 2" dia thick 3mm	Mtr	333			
17	PVC /channel patti 1"/Flexible Pipe 1" dia.	Mtr	500			
18	Warning Tape with NTC monogram	Mtr	333			
19	Angle-Iron Brackets, Clamps, Insulators, Shingles & all Accessories for support & hanging of SSA OFC Cables on poles, buildings etc.	Set	10			
20	Wall Mount Hanging Clamp for Drop Fiber fixing	Box	10			
<b>Sub Total (A) Rs.</b>						

<b>B. SERVICES</b>						
<b>Sr.#</b>	<b>Description</b>	<b>A/U</b>	<b>Qty</b>	<b>Unit Price without (15% SST) Taxes</b>	<b>Unit Price with (15% SST) Taxes</b>	<b>Total Price with Taxes</b>
1	Marking and Excavation in <b>Pacca</b> , Trench 4ft x 1.25ft dimensions, Laying of HDPE pipe at 4ft, pulling of OFC cable, back-filling, disposal of surplus soil, dressing & compacting the soil, proper dumping of joint etc as per standard and specification of NTC/ PTCL <b>(Without ROW)</b>	Mtr	333			
2	Roding/cleaning of existing duct	Mtr	700			
3	Pulling of OFC Cables	Mtr	1,150			
4	Pulling, fixing & hanging of Aerial OFC on wall/pole/roof/ building etc. (length of route will be measured on ground)	Mtr	7,973			
5	Fixing of Drop Fiber through conceal/fore ceiling	Mtr	15,640			
6	Fixing of Angle-Iron Brackets, Clamps, Insulators, Shingles & all Accessories for support & hanging of SSA OFC Cables on poles, buildings etc.	Job	10			
7	Splicing/Joining of OFC in FDH /FAT/Joint enclosure	No	1,084			
8	Installation/fitting of 19" Rack along with support/ installation material etc.	No	3			
9	Installation and fixing of FATs, ODFs, ATBs on walls, or in Rack or in FDH including required accessories etc.	No	1,128			
10	Construction of FDH Cabinet Base as per NTC Standard	No	1			
11	Transportation of NTC Stores from warehouse to Site	Job	1			
<b>Sub Total (B) Rs.</b>						
<b>Grand Total (A+B) Rs.</b>						

**ANNEX-A-3: BOQ FOR LAYING OF OPTICAL DISTRIBUTION NETWORK AT GOVERNOR HOUSE KARACHI**

<b>NTC Store</b>						
<b>Sr. #</b>	<b>Description</b>	<b>A/U</b>	<b>Qty</b>	<b>Unit Price without (18% GST) Taxes</b>	<b>Unit Price with (18% GST) Taxes</b>	<b>Total Price with Taxes</b>
1	Optical Fiber Cable 48 Fibers (duct buried, Single mode G.652)	Mtr	1,180			To be Provided by NTC
2	Optical Fiber Cable 12 Fibers (duct buried, Single mode, G.652)	Mtr	1,135			
3	Aerial Optical Fiber Cable 6 Fibers (Single Mode, G.652D)	Mtr	1,895			
4	2 Fiber Drop Fiber (Single mode)	Mtr	10,575			
5	Joint Enclosure 24 Fiber Complete With all respect	No	3			
6	Joint Enclosure 12 Fiber Complete With all respect	No	4			

**A. STORE**

<b>Sr</b>	<b>Description</b>	<b>A/U</b>	<b>Qty</b>	<b>Unit Price without (18% GST) Taxes</b>	<b>Unit Price with (18% GST) Taxes</b>	<b>Total Price with Taxes</b>
1	Wall Mount FDH (Weatherproof – IP65 or higher, Metal Enclosure) – 48F ODF, Preloaded with SC/APC Adapters & Pigtails, Splice Trays, Cable Management Accessories, and Splitter Mounting Slot, etc.	No	2			
2	19" Rack floor Standing for ODF along with all installation material	No	1			
3	Rack mount ODF of 144 Fiber Pre-Loaded along with SC/APC adapter Pigtails Splice Tray complete etc.	No	1			
4	FDH Splitter 1:2 with Pre-Loaded SC/APC Adapter loaded in Tray etc.	No	2			
5	Bare Fiber NAP Splitter 1:4 with splitter box and SC/APC adapters	No	2			

6	FDH Splitter 1:4 with Pre-Loaded SC/APC Adapter loaded in Tray etc.	No	6			
7	FAT 32x ports pre-loaded along with SC/APC Adapter (single mode), Splitter, Pigtail Splice tray & loss within 10 dbm etc.	No	2			
8	FAT 16x ports pre-loaded along with SC/APC Adapter (single mode), Splitter, Pigtail Splice tray & loss within 10 dbm etc.	No	4			
9	FAT 8x ports pre-loaded along with SC/APC Adapter (single mode), Splitter, Pigtail Splice tray & loss within 10 dbm etc.	No	32			
10	Patch Cord SC/APC (Single mode) 3 meter for FDH/Rack Mount ODF	No	40			
11	Pigtail 1m (single mode) with SC/APC adapter for drop fiber termination to FAT/patch panel	No	141			
12	Patch Cord (Single mode) 10 meter for OLT side	No	16			
13	Access Termination Box (ATB)-OFDF 2-Fiber pre-loaded accessories SC/SC, FC/LC, FC/PC, FC/SC with AC/APC adapters & pigtails	No	141			
14	Field Installable Connector with Mechanical Splice and SC Adapter for drop wire termination	No	141			
15	HDPE Pipe 2" dia thick 3mm	Mtr	855			
16	Warning Tape with NTC monogram	Mtr	855			
17	Angle-Iron Brackets, Clamps, Insulators, Shingles & all Accessories for support & hanging of SSA OFC Cables on poles, buildings etc.	Set	4			
18	Wall Mount Hanging Clamp for Drop Fiber fixing	Box	6			
<b>Sub Total (A) Rs.</b>						

<b>B. SERVICES</b>						
<b>Sr.#</b>	<b>Description</b>	<b>A/U</b>	<b>Qty</b>	<b>Unit Price without (15% SST) Taxes</b>	<b>Unit Price with (15% SST) Taxes</b>	<b>Total Price with Taxes</b>
1	Marking and Excavation in <b>Kacha</b> , Trench 4ft x 1.25ft dimensions, Laying of HDPE pipe at 4ft, pulling of OFC cable, back-filling, disposal of surplus soil, dressing & compacting the soil, proper dumping of joint etc. as per standard and specification of NTC/ PTCL ( <b>Without ROW</b> )	Mtr	855			
2	Fixing/hanging of OFC	Mtr	1,750			
3	Pulling of cable	Mtr	2,315			
4	Fixing of Angle-Iron Brackets, Clamps, Insulators, Shingles & all Accessories for support & hanging of SSA OFC Cables on poles, buildings etc.	Job	2			
5	Splicing/Jointing of OFC in FDH /FAT/Joint enclosure	No	288			
6	Installation/fitting of 19" Rack along with support/ installation material etc.	No	1			
7	Installation and fixing of FATs, ODFs, ATBs on walls, or in Rack or in FDH including required accessories etc	No	180			
8	Fixing/installation of wall mounted FDH	No	2			
9	Transportation of NTC Stores from warehouse to Site	Job	1			
<b>Sub Total (B) Rs.</b>						
<b>Grand Total (A+B) Rs.</b>						

**ANNEX-A-4: BOQ FOR LAYING OF OPTICAL DISTRIBUTION NETWORK AT  
CENTRAL PRISON KARACHI**

<b>NTC Store</b>						
Sr. #	Description	A/U	Qty	Unit Price without (18% GST) Taxes	Unit Price with (18% GST) Taxes	Total Price with Taxes
1	Optical Fiber Cable 48 Fibers (duct buried, Single mode G.652)	Mtr	60	To be Provided by NTC		
2	Aerial Optical Fiber Cable 12 Fibers (Single Mode, G.652D)	Mtr	390			
3	Aerial Optical Fiber Cable 6 Fibers (Single Mode, G.652D)	Mtr	1,640			
4	2 Fiber Drop Fiber (Single mode)	Mtr	7,120			
5	Joint Enclosure 48 Fiber Complete With all respect	No	1			
6	Joint Enclosure 12 Fiber Complete With all respect	No	3			

**B. STORE**

Sr. #	Description	Unit	Qty	Unit Price without (18% GST) Taxes	Unit Price with (18% GST) Taxes	Total Price with Taxes
1	FDH Cabinet (Weatherproof – IP65 or higher, Metal Enclosure) – <b>192F</b> ODF, Preloaded with SC/APC Adapters & Pigtails, Splice Trays, Cable Management Accessories, and Splitter Mounting Slots	No	1			
2	Bare Fiber NAP Splitter 1:4, wall mount with splitter box and SC/APC adapters	No	1			
3	FDH Splitter 1:4 with Pre-Loaded SC/APC Adaptor loaded in Tray etc.	No	3			
4	FAT 8x ports pre-loaded along with SC/APC Adaptor (single mode), Splitter, Pigtail Splice tray & loss within 10 dbm etc.	No	16			
5	Patch Cord SC/APC (Single mode) 3 meter for FDH/Rack Mount ODF	No	24			
6	Pigtail 1m (single mode) with SC/APC adapter for drop fiber termination to FAT/patch panel	No	89			

7	Patch Cord (Single mode) 10 meter for OLT side	No	8			
8	Access Termination Box (ATB)-OFDF 2-Fiber pre-loaded accessories SC/SC, FC/LC, FC/PC, FC/SC with AC/APC adapters & pigtails	No	89			
9	Field Installable Connector with Mechanical Splice and SC Adapter for drop wire termination	No	89			
12	HDPE Pipe 2" dia thick 3mm	Mtr	514			
13	Warning Tape with NTC monogram	Mtr	504			
14	Angle-Iron Brackets, Clamps, Insulators, Shingles & all Accessories for support & hanging of SSA OFC Cables on poles, buildings etc.	Set	2			
15	Wall Mount Hanging Clamp for Drop Fiber fixing	Box	5			

**Sub Total (A) Rs.**

#### B. SERVICES

Sr.#	Description	Unit	Qty	Unit Price without (15% SST) Taxes	Unit Price with (15% SST) Taxes	Total Price with Taxes
1	Marking and Excavation in <b>Pacca</b> , Trench 4ft x 1.25ft dimensions, Laying of HDPE pipe at 4ft, pulling of OFC cable, back-filling, disposal of surplus soil, dressing & compacting the soil, proper dumping of joint etc. as per standard and specification of NTC/ PTCL <b>(Without ROW)</b>	Mtr	504			
2	Bore without ROW	Mtr	10			
3	Construction of Hand Hole (3x3x4ft) RCC Type with opening cover	No	4			
4	Fixing/hanging of OFC	Mtr	1,626			
5	Pulling of cable	Mtr	540			
6	Fixing of Angle-Iron Brackets, Clamps, Insulators, Shingles & all Accessories for support & hanging of SSA OFC Cables on poles, buildings etc.	Job	2			

7	Splicing/Jointing of OFC in FDH /FAT/Joint enclosure	No	213			
8	Installation and fixing of FATs, ODFs, ATBs on walls, or in Rack or in FDH including required accessories etc.	No	105			
9	Construction of FDH Cabinet Base as per NTC Standard	No	1			
10	Transportation of NTC Stores from warehouse to Site	Job	1			
<b>Sub Total (B) Rs.</b>						
<b>Grand Total (A+B) Rs.</b>						

**ANNEX-A-5: BOQ FOR LAYING OF OPTICAL DISTRIBUTION NETWORK AT  
PTV STATION, KARACHI**

<b>NTC Store</b>						
<b>Sr. #</b>	<b>Description</b>	<b>Unit</b>	<b>Qty</b>	<b>Unit Price without (18% GST) Taxes</b>	<b>Unit Price with (18% GST) Taxes</b>	<b>Total Price with Taxes</b>
1	Optical Fiber Cable 96 Fibers (duct buried, Single mode G.652)	Mtr	280	To be Provided by NTC		
2	Optical Fiber Cable 24 Fibers (duct buried, Single mode G.652)	Mtr	820			
3	Optical Fiber Cable 12 Fibers (duct buried, Single mode G.652)	Mtr	50			
4	Aerial Optical Fiber Cable 6 Fibers (Single Mode, G.652D)	Mtr	2,200			
5	2 Fiber Drop Fiber (Single mode)	Mtr	13,200			
6	Joint Enclosure 48 Fiber Complete with all respect	No	2			
7	Joint Enclosure 24 Fiber Complete with all respect	No	1			
8	Joint Enclosure 06 Fiber Complete with all respect	No	1			

**A. STORE**

<b>Sr</b>	<b>Description</b>	<b>A/U</b>	<b>Qty</b>	<b>Unit Price without (18% GST) Taxes</b>	<b>Unit Price with (18% GST) Taxes</b>	<b>Total Price with Taxes</b>
1	FDH Cabinet (Weatherproof – IP65 or higher, Metal Enclosure) – <b>192F</b> ODF, Preloaded with SC/APC Adapters & Pigtails, Splice Trays, Cable Management Accessories, and Splitter Mounting Slots	No	1			
2	FDH Wall Mount (Weatherproof – IP65 or higher, Metal Enclosure) – <b>24F</b> ODF, Preloaded with SC/APC Adapters & Pigtails, Splice Trays, Cable Management Accessories, and Splitter Mounting Slots	No	1			
3	19" Rack floor Standing for ODF along with all installation material	No	1			
4	Rack mount ODF of <b>120 Fiber</b> Pre-Loaded along with SC/APC	No	1			

	adopter Pigtails Splice Tray complete etc.					
5	FDH Splitter 1:2 with Pre-Loaded SC/APC Adopter loaded in Tray etc.	No	5			
6	FDH Splitter 1:4 with Pre-Loaded SC/APC Adopter loaded in Tray etc.	No	4			
7	FAT 16x ports pre-loaded along with SC/APC Adopter (single mode), Splitter, Pigtail Splice tray & loss within 10 dbm etc.	No	10			
8	FAT 8x ports pre-loaded along with SC/APC Adopter (single mode), Splitter, Pigtail Splice tray & loss within 10 dbm etc.	No	16			
9	Patch Cord SC/APC (Single mode) 3 meter for FDH/Rack Mount ODF	No	36			
10	Pigtail 1m (single mode) with SC/APC adapter for drop fiber termination to FAT/patch panel	No	165			
11	Patch Cord (Single mode) 10 meter for OLT side	No	16			
12	Access Termination Box (ATB)- OFDF 2-Fiber pre-loaded accessories SC/SC, FC/LC, FC/PC, FC/SC with AC/APC adapters & pigtails	No	165			
13	Field Installable Connector with Mechanical Splice and SC Adapter for drop wire termination	No	165			
14	HDPE Pipe 2" dia thick 3mm	Mtr	618			
15	Warning Tape with NTC monogram	Mtr	618			
16	Angle-Iron Brackets, Clamps, Insulators, Shingles & all Accessories for support & hanging of SSA OFC Cables on poles, buildings etc.	Set	2			
17	Wall Mount Hanging Clamp for Drop Fiber fixing	Box	5			
<b>Sub Total (A) Rs.</b>						

<b>B. SERVICES</b>						
<b>Sr.#</b>	<b>Description</b>	<b>A/U</b>	<b>Qty</b>	<b>Unit Price without (15% SST) Taxes</b>	<b>Unit Price with (15% SST) Taxes</b>	<b>Total Price with Taxes</b>
1	Marking and Excavation in Pacca, Trench 4ft x 1.25ft dimensions, Laying of HDPE pipe at 4ft, pulling of OFC cable, back-filling, disposal of surplus soil, dressing & compacting the soil, proper dumping of joint etc as per standard and specification of NTC/ PTCL <b>(With ROW)</b>	Mtr	618			
2	Fixing/hanging of OFC	Mtr	1,930			
3	Construction of Hand Hole (3x3x4ft) RCC Type with opening cover	No	3			
4	Fixing of Drop Fiber through conceal	Mtr	500			
5	Pulling of cable	Mtr	650			
6	Fixing of Angle-Iron Brackets, Clamps, Insulators, Shingles & all Accessories for support & hanging of SSA OFC Cables on poles, buildings etc.	Job	2			
7	Splicing/Jointing of OFC in FDH /FAT/Joint enclosure	No	462			
8	Installation/fitting of 19" Rack along with support/ installation material etc.	No	1			
9	Installation and fixing of FATs, ODFs, ATBs on walls, or in Rack or in FDH including required accessories etc.	No	191			
10	Construction of FDH Cabinet Base as per NTC Standard	No	1			
11	Transportation of NTC Stores from warehouse to Site	Job	1			
<b>Sub Total (B) Rs.</b>						
<b>Grand Total (A+B) Rs.</b>						

**ANNEX-A-6: BOQ FOR LAYING OF OPTICAL DISTRIBUTION NETWORK AT PAK CAPITAL EXCHANGE KARACHI**

<b>NTC Store</b>						
Sr. #	Description	A/U	Qty	Unit Price without (18% GST) Taxes	Unit Price with (18% GST) Taxes	Total Price with Taxes
1	Optical Fiber Cable 12 Fibers (duct buried, Single mode G.652)	Mtr	560			To be Provided by NTC
2	Aerial Optical Fiber Cable 6 Fibers (Single Mode, G.652D)	Mtr	630			
3	2 Fiber Drop Fiber (Single mode)	Mtr	3,200			
4	Joint Enclosure 12 Fiber Complete with all respect	No	1			

**A. STORE**

Sr	Description	Unit	Qty	Unit Price without (18% GST) Taxes	Unit Price with (18% GST) Taxes	Total Price with Taxes
1	19" Rack floor Standing for ODF along with all installation material	No	1			
2	Rack mount ODF of <b>12 Fiber</b> Pre-Loaded along with SC/APC adopter Pigtailes Splice Tray complete etc.	No	2			
3	FDH Splitter 1:2 with Pre-Loaded SC/APC Adopter loaded in Tray etc.	No	2			
4	Bare Fiber Splitter 1:4 with Pre-Loaded SC/APC Adopter loaded in Tray etc.	No	1			
5	FAT 16x ports pre-loaded along with SC/APC Adopter (single mode), Splitter, Pigtail Splice tray & loss within 10 dbm etc.	No	4			
6	FAT 8x ports pre-loaded along with SC/APC Adopter (single mode), Splitter, Pigtail Splice tray & loss within 10 dbm etc.	No	4			
7	Patch Cord SC/APC (Single mode) 3 meter for FDH/Rack Mount ODF	No	48			
8	Pigtail 1m (single mode) with SC/APC adapter for drop fiber termination to FAT/patch panel	No	40			
9	Patch Cord (Single mode) 10 meter for OLT side	No	24			
10	Access Termination Box (ATB)- OFDF 2-Fiber pre-loaded accessories SC/SC, FC/LC, FC/PC, FC/SC with AC/APC adapters & pigtails	No	40			

11	Field Installable Connector with Mechanical Splice and SC Adapter for drop wire termination	No	40			
12	HDPE Pipe 2" dia thic 3mm	Mtr	520			
13	Warning Tape with NTC monogram	Mtr	500			
14	Angle-Iron Brackets, Clamps, Insulators, Shingles & all Accessories for support & hanging of SSA OFC Cables on poles, buildings etc.	Set	4			
15	Wall Mount Hanging Clamp for Drop Fiber fixing	Box	5			
<b>Sub Total (A) Rs.</b>						

<b>B. SERVICES</b>						
Sr.#	Description	Unit	Qty	Unit Price without (15% SST) Taxes	Unit Price with (15% SST) Taxes	Total Price with Taxes
1	Marking and Excavation in Pacca, Trench 4ft x 1.25ft dimensions, Laying of HDPE pipe at 4ft, pulling of OFC cable, back-filling, disposal of surplus soil, dressing & compacting the soil, proper dumping of joint etc. as per standard and specification of NTC/ PTCL (With ROW)	Mtr	520			
2	Fixing/hanging of OFC	Mtr	740			
3	Construction of Hand Hole (3x3x4ft) RCC Type with opening cover	No	2			
4	Pulling of cable	Mtr	530			
5	Fixing of Angle-Iron Brackets, Clamps, Insulators, Shingles & all Accessories for support & hanging of SSA OFC Cables on poles, buildings etc.	Job	3			
6	Splicing/Jointing of OFC in FDH /ODF/FAT/Joint enclosure	No	128			
7	Installation/fitting of 19" Rack along with support/ installation material etc.	No	1			
8	Installation and fixing of FATs, ODFs, ATBs on walls, or in Rack or in FDH including required accessories etc.	No	51			
9	Transportation of NTC Stores from warehouse to Site	Job	1			
<b>Sub Total (B) Rs.</b>						
<b>Grand Total (A+B) Rs.</b>						

**ANNEX-A-7: BOQ FOR LAYING OF OPTICAL DISTRIBUTION NETWORK AT FBR GULSHAN KARACHI**

<b>NTC Store</b>						
<b>Sr. #</b>	<b>Description</b>	<b>Unit</b>	<b>Qty</b>	<b>Unit Price without (18% GST) Taxes</b>	<b>Unit Price with (18% GST) Taxes</b>	<b>Total Price with Taxes</b>
1	Optical Fiber Cable 48 Fibers (duct buried, Single mode G.652)	Mtr	170	To be Provided by NTC		
2	Optical Fiber Cable 24 Fibers (duct buried, Single mode G.652)	Mtr	590			
3	Aerial Optical Fiber Cable 6 Fibers (Single Mode, G.652D)	Mtr	5,080			
4	2 Fiber Drop Fiber (Single mode)	Mtr	22,470			
5	Joint Enclosure 96 Fiber Complete With all respect	No	4			
6	Joint Enclosure 12 Fiber Complete With all respect	No	1			

**A. STORE**

<b>Sr. #</b>	<b>Description</b>	<b>A/U</b>	<b>Qty</b>	<b>Unit Price without (18% GST) Taxes</b>	<b>Unit Price with (18% GST) Taxes</b>	<b>Total Price with Taxes</b>
1	FDH Cabinet (Weatherproof – IP65 or higher, Metal Enclosure) – <b>60F</b> ODF, fully preloaded with SC/APC Adapters & Pigtailes, Splice Trays, Cable Management Accessories, and Splitter Mounting Slots. (Indoor/Outdoor)	No	1			
2	FDH Cabinet (Weatherproof – IP65 or higher, Metal Enclosure) – <b>96F</b> ODF, fully preloaded with SC/APC Adapters & Pigtailes, Splice Trays, Cable Management Accessories, and Splitter Mounting Slots. (Indoor/Outdoor)	No	1			
3	Rack mount ODF of <b>12 Ports</b> Pre-Loaded along with SC/APC adopter Pigtailes Splice Tray complete etc.	No	2			
4	FDH Splitter 1:2 with Pre-Loaded SC/APC Adopter loaded in Tray	No	4			

	etc.					
5	PLC Wall Mounted Splitter 1:2, wall mount with splitter box and SC/APC adopters	No	2			
6	Bare Fiber Splitter 1:4, wall mount with splitter box and SC/APC adopters	No	2			
7	FDH Splitter 1:4 with Pre-Loaded SC/APC Adopter loaded in Tray etc.	No	4			
8	FAT 16x ports pre-loaded along with SC/APC Adopter (single mode), Splitter, Pigtail Splice tray & loss within 10 dbm etc.	No	12			
9	FAT 8x ports pre-loaded along with SC/APC Adopter (single mode), Splitter, Pigtail Splice tray & loss within 10 dbm etc.	No	24			
10	Pigtail 1m (single mode) with SC/APC adapter for drop fiber termination to FAT/patch panel	No	301			
11	Patch Cord SC/APC (Single mode) 3 meter for FDH/Rack Mount ODF	No	242			
12	Patch Cord (Single mode) 10 meter for OLT side	No	12			
13	Access Termination Box (ATB)- OFDF 2-Fiber pre-loaded accessories SC/SC, FC/LC, FC/PC, FC/SC with AC/APC adapters & pigtails	No	301			
14	Field Installable Connector with Mechanical Splice and SC Adapter for drop wire termination	No	301			
15	HDPE Pipe 2.25" dia thick 3mm	Mtr	534			
16	PVC /channel patti 1"/Flexible Pipe 1" dia.	Mtr	220			
18	Warning Tape with NTC monogram	Mtr	48			
19	Angle-Iron Brackets, Clamps, Insulators, Shingles & all Accessories for support & hanging of SSA OFC Cables on poles, buildings etc.	Set	19			
20	Wall Mount Hanging Clamp for Drop Fiber fixing	Box	30			
<b>Sub Total (A) Rs.</b>						

<b>B. SERVICES</b>						
<b>Sr.#</b>	<b>Description</b>	<b>A/U</b>	<b>Qty</b>	<b>Unit Price without (15% SST) Taxes</b>	<b>Unit Price with (15% SST) Taxes</b>	<b>Total Price with Taxes</b>
1	Marking and Excavation in <b>Pacca</b> , Trench 4ft x 1.25ft dimensions, Laying of HDPE pipe at 4ft, pulling of OFC cable, back-filling, disposal of surplus soil, dressing & compacting the soil, proper dumping of joint etc. as per standard and specification of NTC/ PTCL ( <b>With ROW</b> )	Mtr	524			
2	Boring of Road with ROW	Mtr	10			
3	Construction of Hand Hole (3x3x4ft) RCC Type with opening cover	No	1			
4	Pulling of OFC Cables	Mtr	560			
5	Pulling, fixing & hanging of Aerial OFC on wall/pole/roof/ building etc. (length of route will be measured on ground)	Mtr	5,250			
6	Fixing of Drop Fiber through conceal	Mtr	4,310			
7	Fixing of Angle-Iron Brackets, Clamps, Insulators, Shingles & all Accessories for support & hanging of SSA OFC Cables on poles, buildings etc.	Job	19			
8	Splicing/Jointing of OFC in FDH /FAT/Joint enclosure	No	502			
9	Installation and Fixing of FATs, ODFs, ATBs on walls, or in Rack or in FDH including required accessories etc.	No	351			
10	Construction of FDH Cabinet Base as per NTC Standard	No	2			
11	Transportation of NTC Stores from warehouse to Site	Job	1			
<b>Sub Total (B) Rs.</b>						
<b>Grand Total (A+B) Rs.</b>						

**ANNEX-A-8: BOQ FOR LAYING OF OPTICAL DISTRIBUTION NETWORK AT HYDERABAD DIVISION**

<b>NTC Store</b>						
<b>Sr. #</b>	<b>Description</b>	<b>A/U</b>	<b>Qty</b>	<b>Unit Price without (18% GST) Taxes</b>	<b>Unit Price with (18% GST) Taxes</b>	<b>Total Price with Taxes</b>
1	Optical Fiber Cable 96 Fibers (duct buried, Single mode G.652)	Mtr	2,590	To be Provided by NTC		
2	Optical Fiber Cable 48 Fibers (duct buried, Single mode G.652)	Mtr	956			
3	Optical Fiber Cable 24 Fibers (duct buried, Single mode G.652)	Mtr	2,716			
4	Optical Fiber Cable 12 Fibers (Single Mode, G.652D)	Mtr	2,421			
5	Optical Fiber Cable 6 Fibers (Single Mode, G.652D)	Mtr	8,485			
6	2 Fiber Drop Fiber (Single mode)	Mtr	85,765			
7	Joint Enclosure 24Fiber Complete With all respect	No	4			
8	Joint Enclosure 12Fiber Complete With all respect	No	3			
9	Joint Enclosure 6 Fiber Complete With all respect	No	5			

**A. STORE**

<b>Sr. #</b>	<b>Description</b>	<b>A/U</b>	<b>Qty</b>	<b>Unit Price without (18% GST) Taxes</b>	<b>Unit Price with (18% GST) Taxes</b>	<b>Total Price with Taxes</b>
1	FDH Cabinet (Weatherproof – IP65 or higher, Metal Enclosure) – <b>216F</b> ODF, fully preloaded with SC/APC Adapters & Pigtails, Splice Trays, Cable Management Accessories, and Splitter Mounting Slots. (Indoor/Outdoor)	No	1			
2	FDH Cabinet (Weatherproof – IP65 or higher, Metal Enclosure) – <b>96F</b> ODF, fully preloaded with SC/APC Adapters & Pigtails, Splice Trays, Cable Management Accessories, and Splitter Mounting Slots. (Indoor/Outdoor)	No	2			
3	FDH Cabinet (Weatherproof – IP65 or higher, Metal Enclosure) – <b>84F</b> ODF, fully preloaded with SC/APC Adapters & Pigtails, Splice Trays, Cable Management Accessories, and Splitter Mounting Slots. (Indoor/Outdoor)		3			

4	FDH Cabinet (Weatherproof – IP65 or higher, Metal Enclosure) – <b>48F</b> ODF, fully preloaded with SC/APC Adapters & Pigtails, Splice Trays, Cable Management Accessories, and Splitter Mounting Slots. (Indoor/Outdoor)	No	3			
5	FDH Wall Mount (Weatherproof – IP65 or higher, Metal Enclosure) – <b>24F</b> ODF, Preloaded with SC/APC Adapters & Pigtails, Splice Trays, Cable Management Accessories, and Splitter Mounting Slots	No	1			
6	19" Rack floor Standing for ODF along with all installation material	No	1			
7	Rack mount ODF of <b>96 Ports</b> Pre-Loaded along with SC/APC adopter Pigtails Splice Tray complete etc.	No	3			
8	Rack mount ODF of <b>24 Ports</b> Pre-Loaded along with SC/APC adopter Pigtails Splice Tray complete etc.	No	3			
9	FDH Splitter 2:2 with Pre-Loaded SC/APC Adopter loaded in Tray etc.	No	30			
10	Bare Fiber Splitter 2:2 wall mount with splitter box and SC/APC adopters	No	1			
11	FDH Splitter 2:4 with Pre-Loaded SC/APC Adopter loaded in Tray etc.	No	4			
12	Bare Fiber Splitter 2:4 with Pre-Loaded SC/APC Adopter loaded in Tray etc.	No	3			
13	FAT 32x ports pre-loaded along with SC/APC Adopter (single mode), Splitter, Pigtail Splice tray & loss within 10 dbm etc.	No	2			
14	FAT 16x ports pre-loaded along with SC/APC Adopter (single mode), Splitter, Pigtail Splice tray & loss within 10 dbm etc.	No	62			
15	FAT 8x ports pre-loaded along with SC/APC Adopter (single mode), Splitter, Pigtail Splice tray & loss within 10 dbm etc.	No	28			
16	Pigtail 1m (single mode) with SC/APC adapter for drop fiber termination to FAT/patch panel	No	997			
17	Patch Cord SC/APC (Single mode) 3 meter for FDH/Rack Mount ODF	No	828			
18	Patch Cord (Single mode) 10 meter for OLT side	No	40			

19	Access Termination Box (ATB)-OFDF 2-Fiber pre-loaded accessories SC/SC, FC/LC, FC/PC, FC/SC with adapters & pigtails	No	997			
20	Field Installable Connector with Mechanical Splice and SC Adapter for drop wire termination	No	997			
21	HDPE Pipe 2.25"dia thic 3mm	Mtr	11,437			
22	Warning Tape with NTC monogram	Mtr	11,224			
23	Angle-Iron Brackets, Clamps, Insulators, Shingles & all Accessories for support & hanging of SSA OFC Cables on poles, buildings etc.	Set	22			
24	Wall Mount Hanging Clamp for Drop Fiber fixing	Box	20			

**Sub Total (B) Rs.**

**B. SERVICES**

Sr.#	Description	Unit	Qty	Unit Price without (15% SST) Taxes	Unit Price with (15% SST) Taxes	Total Price with Taxes
1	Marking and Excavation in <b>Pacca</b> , Trench 4ft x 1.25ft dimensions, Laying of HDPE pipe at 4ft, pulling of OFC cable, back-filling, disposal of surplus soil, dressing & compacting the soil, proper dumping of joint etc as per standard and specification of NTC/ PTCL ( <b>With ROW</b> )	Mtr	4,417			
2	Marking and Excavation in <b>Kacha</b> , Trench 4ft x 1.25ft dimensions, Laying of HDPE pipe at 4ft, pulling of OFC cable, back-filling, disposal of surplus soil, dressing & compacting the soil, proper dumping of joint etc as per standard and specification of NTC/ PTCL ( <b>With ROW</b> )	Mtr	6,807			
3	Bore (with ROW)	Mtr	226			
4	Roding/cleaning of existing duct	Mtr	1,230			
5	Construction of Hand Hole (3x3x4ft) RCC Type with opening cover	No	33			
6	Pulling of OFC Cables	Mtr	14,960			

7	Pulling, fixing & hanging of Aerial/OFC on wall/pole/roof/ building etc. (length of route will be measured on ground)	Mtr	1,665			
8	Fixing of Drop Fiber through conceal	Mtr	24,000			
9	Fixing of Angle-Iron Brackets, Clamps, Insulators, Shingles & all Accessories for support & hanging of SSA OFC Cables on poles, buildings etc.	Job	22			
10	Splicing/Jointing of OFC in FDH /ODF/FAT/Joint enclosure	No	2,857			
11	Installation/fitting of 19" Rack along with support/ installation material etc.	No	1			
12	Installation and fixing of FATs, ODFs, ATBs on walls, or in Rack or in FDH including required accessories etc	No	1,094			
13	Construction of FDH Cabinet Base as per NTC Standard	No	10			
14	Transportation of NTC Stores from warehouse to Site	Job	1			
<b>Sub Total (B) Rs.</b>						
<b>Grand Total (A+B) Rs.</b>						

**ANNEX-A-9: BOQ FOR LAYING OF OPTICAL DISTRIBUTION NETWORK  
AT SUJAWAL DISTRICT**

<b>NTC Store</b>						
<b>Sr. #</b>	<b>Description</b>	<b>A/U</b>	<b>Qty</b>	<b>Unit Price without (18% GST) Taxes</b>	<b>Unit Price with (18% GST) Taxes</b>	<b>Total Price with Taxes</b>
1	Optical Fiber Cable 48 Fibers (duct buried, Single mode G.652)	Mtr	1,166	To be Provided by NTC		
2	Optical Fiber Cable 24 Fibers (duct buried, Single mode G.652)	Mtr	426			
3	Optical Fiber Cable 12 Fibers (Single Mode, G.652D)	Mtr	690			
4	Optical Fiber Cable 6 Fibers (duct buried, Single Mode, G.652D)	Mtr	1,080			
5	2 Fiber Drop Fiber (Single mode)	Mtr	7,000			
6	Joint Enclosure 48 Fiber Complete With all respect	No	3			
7	Joint Enclosure 24 Fiber Complete With all respect	No	1			
8	Joint Enclosure 12 Fiber Complete With all respect	No	3			

**A. STORE**

<b>Sr</b>	<b>Description</b>	<b>A/U</b>	<b>Qty</b>	<b>Unit Price without (18% GST) Taxes</b>	<b>Unit Price with (18% GST) Taxes</b>	<b>Total Price with Taxes</b>
1	FDH Cabinet (Weatherproof – IP65 or higher, Metal Enclosure) – <b>48F</b> ODF, fully preloaded with SC/APC Adapters & Pigtails, Splice Trays, Cable Management Accessories, and Splitter Mounting Slots. (Indoor/Outdoor)	No	1			
2	19" Rack floor Standing for ODF along with all installation material	No	1			
3	Rack mount ODF of <b>48 Ports</b> Pre-Loaded along with SC/APC adopter Pigtails Splice Tray complete etc.	No	1			

4	Rack mount ODF of <b>12 Ports</b> Pre-Loaded along with SC/APC adopter Pigtails Splice Tray complete etc.	No	1			
5	FDH Splitter 2:2 with Pre-Loaded SC/APC Adopter loaded in Tray etc.	No	1			
6	FDH Splitter 2:4 with Pre-Loaded SC/APC Adopter loaded in Tray, etc.	No	4			
7	FAT 16x ports pre-loaded along with 1:16 Splitter, SC/APC Adopter (single mode), Splitter, Pigtail Splice tray & loss within 10 dbm etc.	No	2			
8	FAT 8x ports pre-loaded along with 1:8 Splitter, SC/APC Adopter (single mode), Splitter, Pigtail Splice tray & loss within 10 dbm etc.	No	16			
9	Pigtail 1m (single mode) with SC/APC adapter for drop fiber termination to FAT/patch panel	No	64			
10	Patch Cord SC/APC (Single mode) 3 meter for FDH/Rack Mount ODF	No	96			
11	Patch Cord (Single mode) 10 meter for OLT side	No	8			
12	Access Termination Box (ATB)-OFDF 2-Fiber pre-loaded accessories SC/SC, FC/LC, FC/PC, FC/SC with adapters & pigtails	No	64			
13	Field Installable Connector with Mechanical Splice and SC Adapter for drop wire termination	No	64			
14	HDPE Pipe 2"dia thic 3mm	Mtr	3,200			
15	Warning Tape with NTC monogram	Mtr	3,078			

16	Angle-Iron Brackets, Clamps, Insulators, Shingles & all Accessories for support & hanging of SSA OFC Cables on poles, buildings etc.	Set	2			
17	Wall Mount Hanging Clamp for Drop Fiber fixing	Box	10			

**Sub Total (A) Rs.**

**B. SERVICES**

Sr.#	Description	Unit	Qty	Unit Price without (15% SST) Taxes	Unit Price with (15% SST) Taxes	Total Price with Taxes
1	Marking and Excavation in <b>Pacca</b> , Trench 4ft x 1.25ft dimensions, Laying of HDPE pipe at 4ft, pulling of OFC cable, back-filling, disposal of surplus soil, dressing & compacting the soil, proper dumping of joint etc. as per standard and specification of NTC/ PTCL ( <b>With ROW</b> )	Mtr	1,147			
2	Marking and Excavation in <b>Kacha</b> , Trench 4ft x 1.25ft dimensions, Laying of HDPE pipe at 4ft, pulling of OFC cable, back-filling, disposal of surplus soil, dressing & compacting the soil, proper dumping of joint etc as per standard and specification of NTC/ PTCL ( <b>With ROW</b> )	Mtr	1,931			
3	Bore (with ROW)	Mtr	122			
4	Construction of Hand Hole (3x3x4ft) RCC Type with opening cover	No	15			
5	Pulling of OFC Cables	Mtr	3,362			
6	Fixing of Drop Fiber through conceal	Mtr	500			
7	Fixing of Angle-Iron Brackets, Clamps, Insulators, Shingles & all Accessories for support & hanging of SSA OFC Cables on poles, buildings etc.	Job	2			

8	Splicing/Jointing of OFC in FDH /FAT/Joint enclosure	No	210			
9	Installation/fitting of 19" Rack along with support/ installation material etc.	No	1			
10	Installation and fixing of FATs, ODFs, ATBs on walls, or in Rack or in FDH including required accessories etc.	No	84			
11	Construction of FDH Cabinet Base as per NTC Standard	No	1			
12	Transportation of NTC Stores from warehouse to Site	Job	1			
<b>Sub Total (B) Rs.</b>						
<b>Grand Total (A+B) Rs.</b>						

## ANNEX-B-1: LAYOUT DIAGRAM CM HOUSE

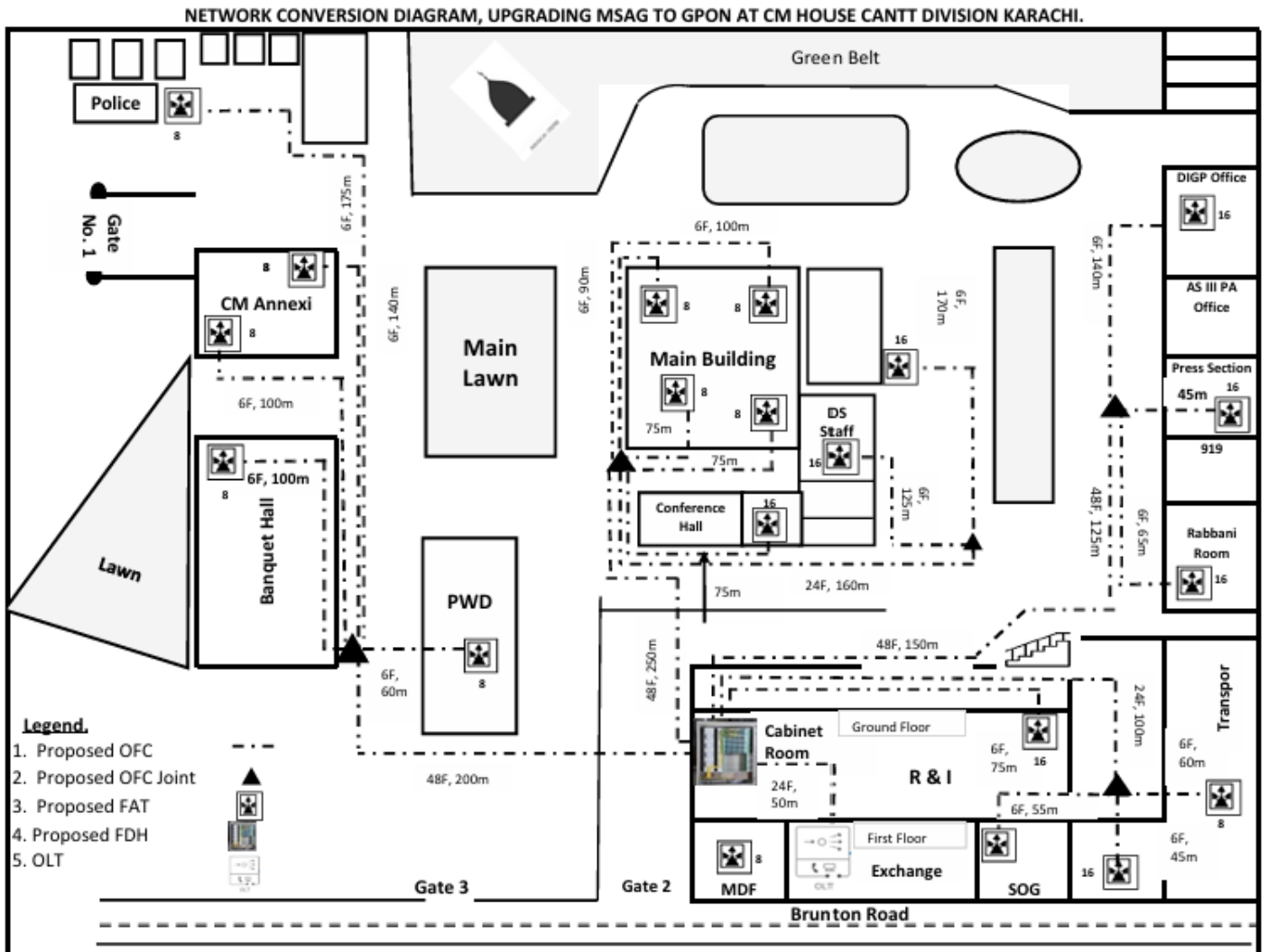

## ANNEX-B-2: LAYOUT DIAGRAM SINDH SECRETARIAT (1)

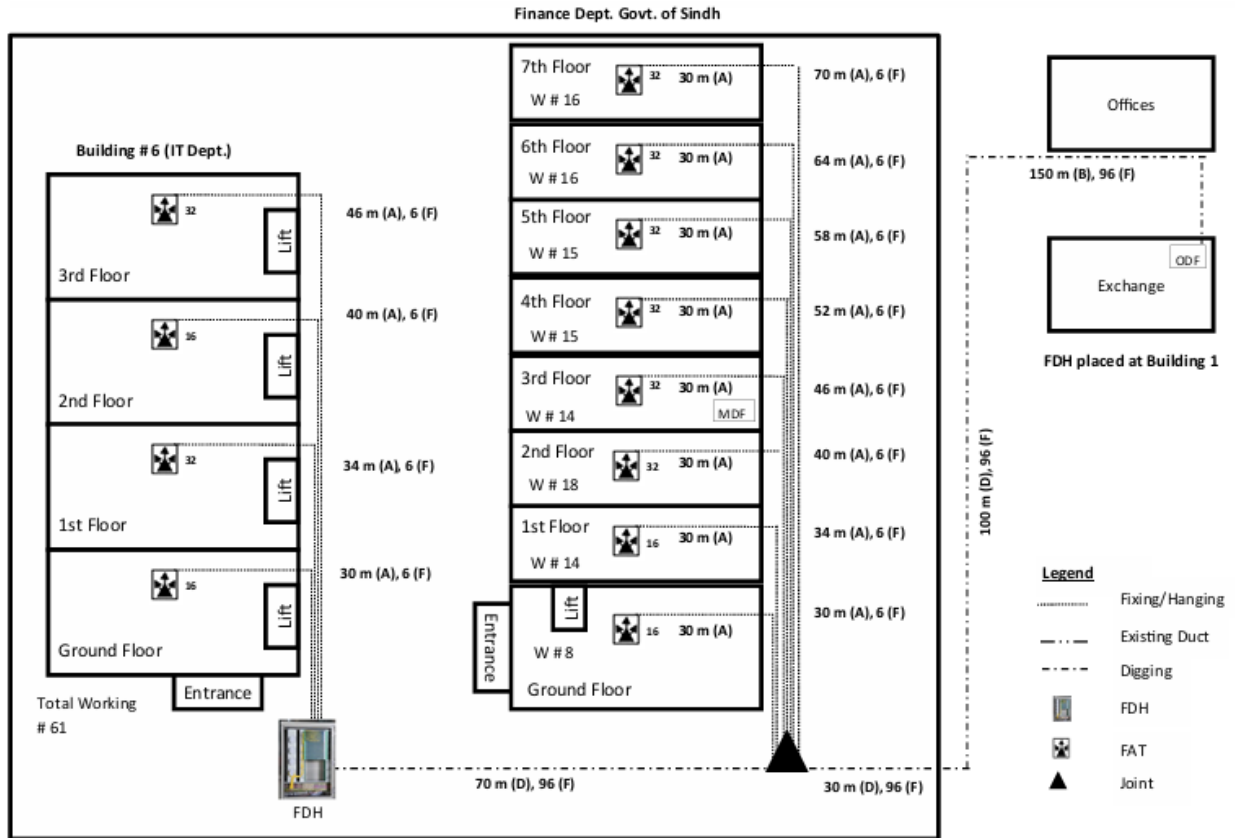

## ANNEX-B-2: LAYOUT DIAGRAM SINDH SECRETARIAT (2)

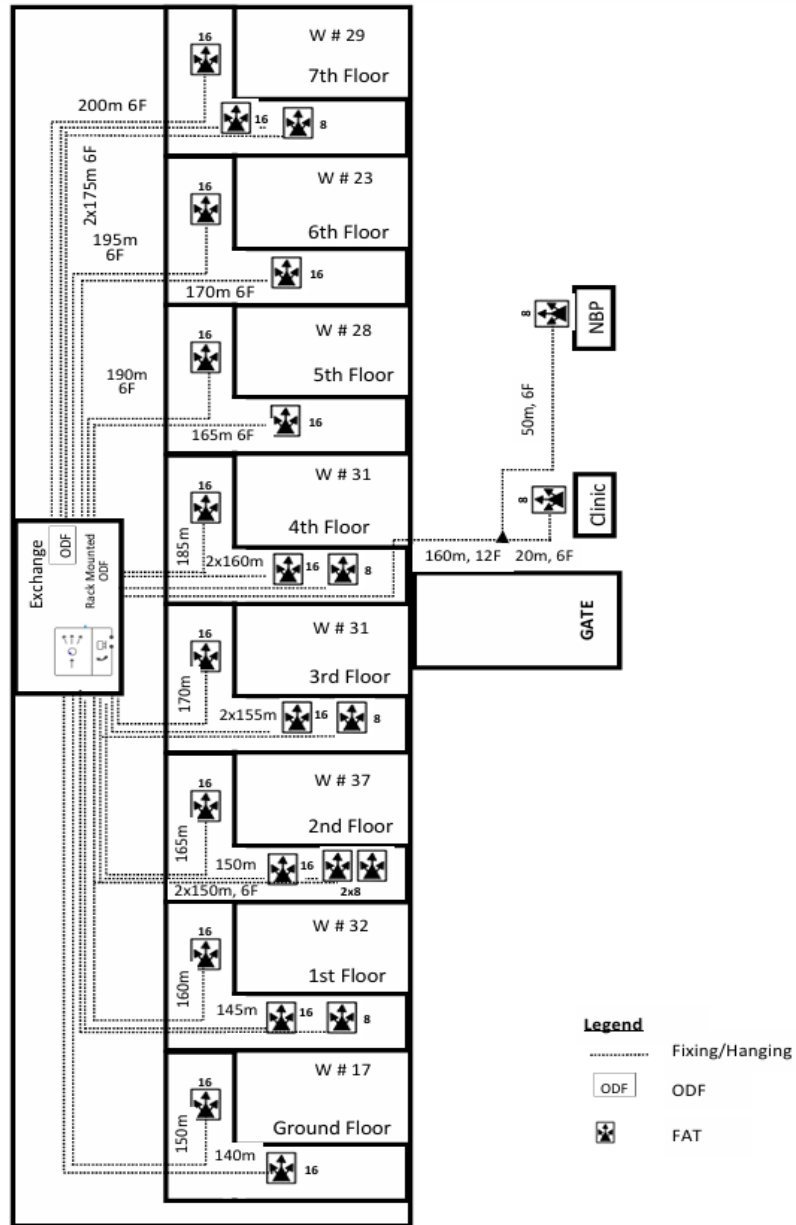

### ANNEX-B-2: LAYOUT DIAGRAM SINDH SECRETARIAT (3)

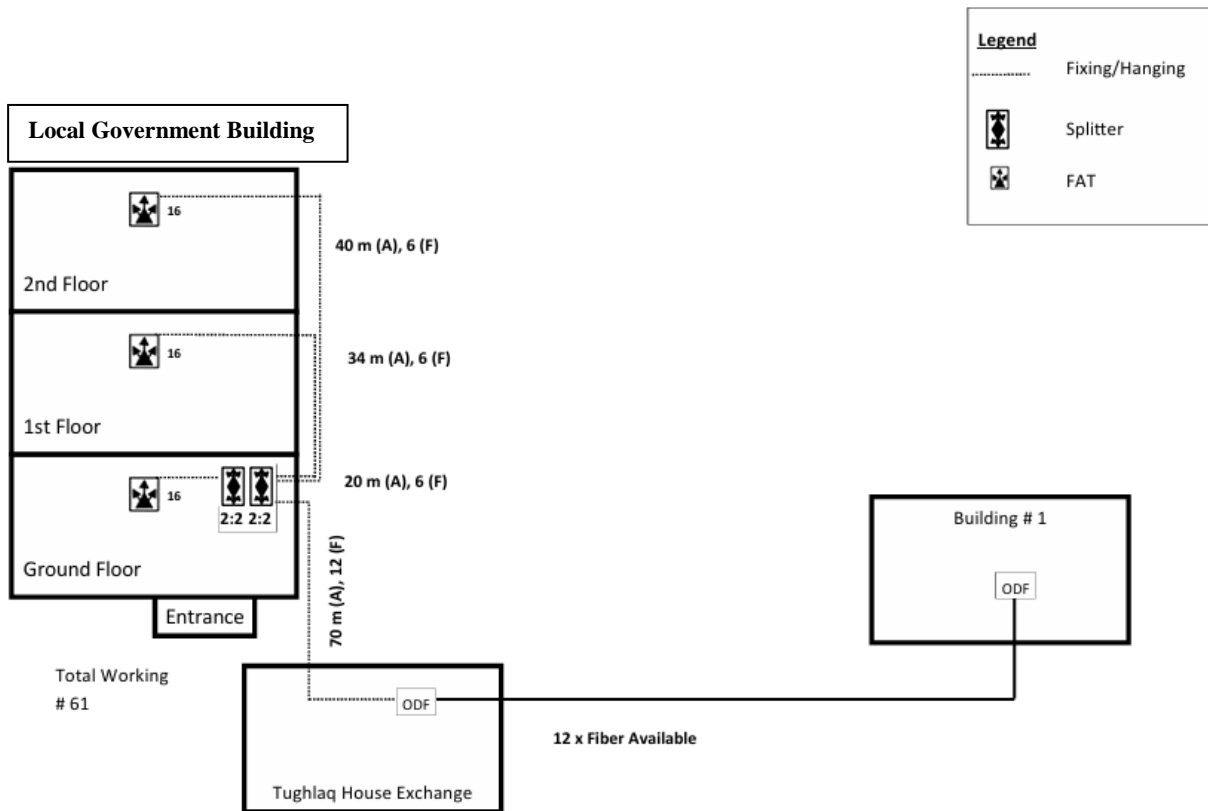

## ANNEX-B-2: LAYOUT DIAGRAM SINDH SECRETARIAT (4)

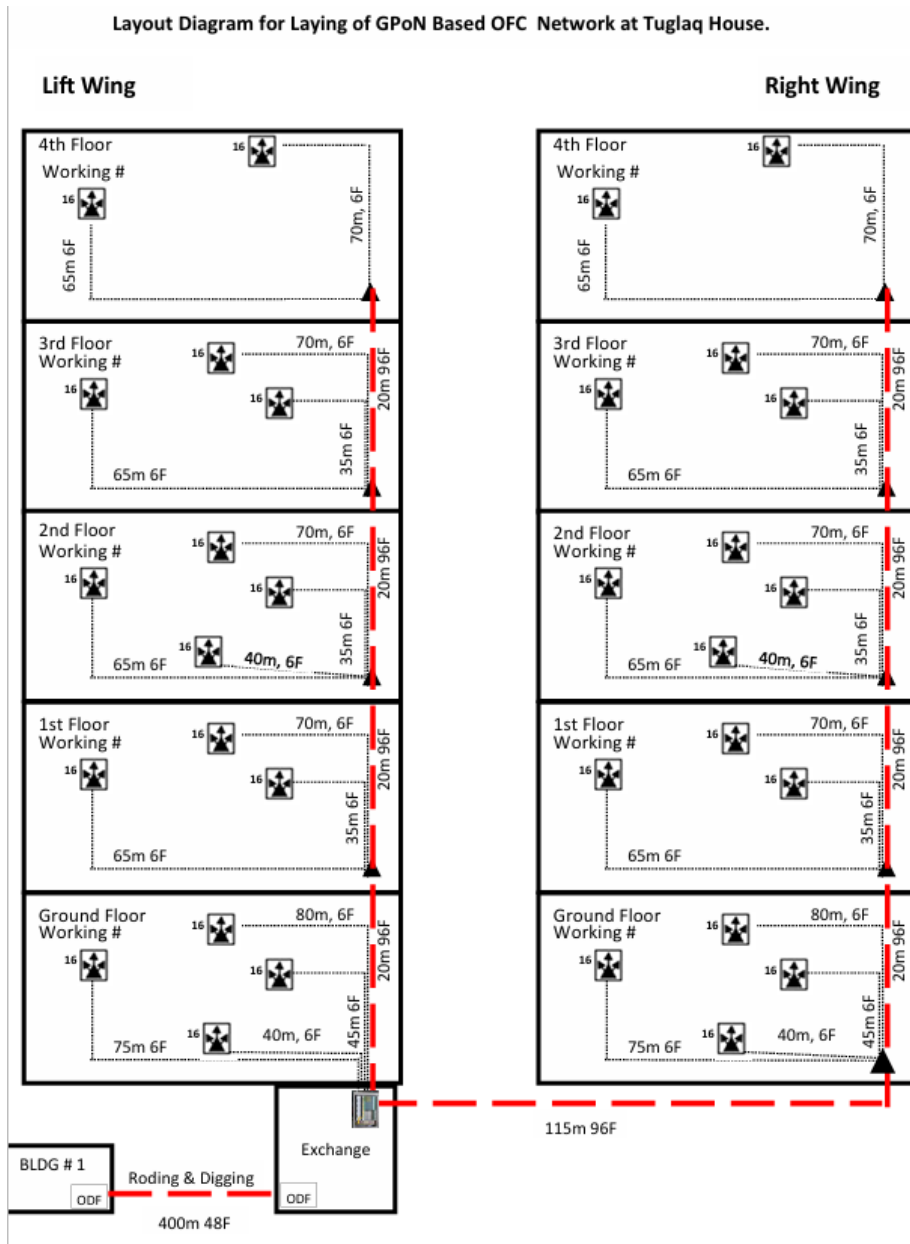

## ANNEX-B-2: LAYOUT DIAGRAM SINDH SECRETARIAT (5)

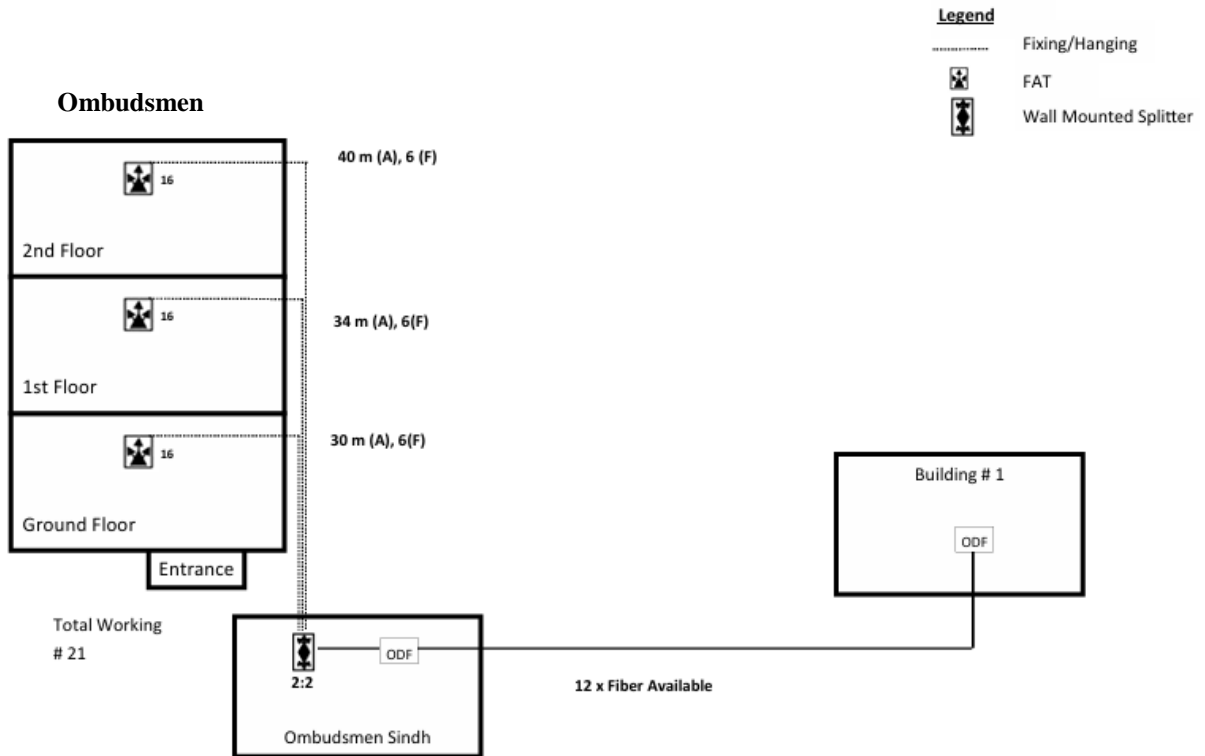

## ANNEX-B-2: LAYOUT DIAGRAM SINDH SECRETARIAT (6)

Layout Diagram for Laying of GPoN Based OFC Network at Old KDA Building

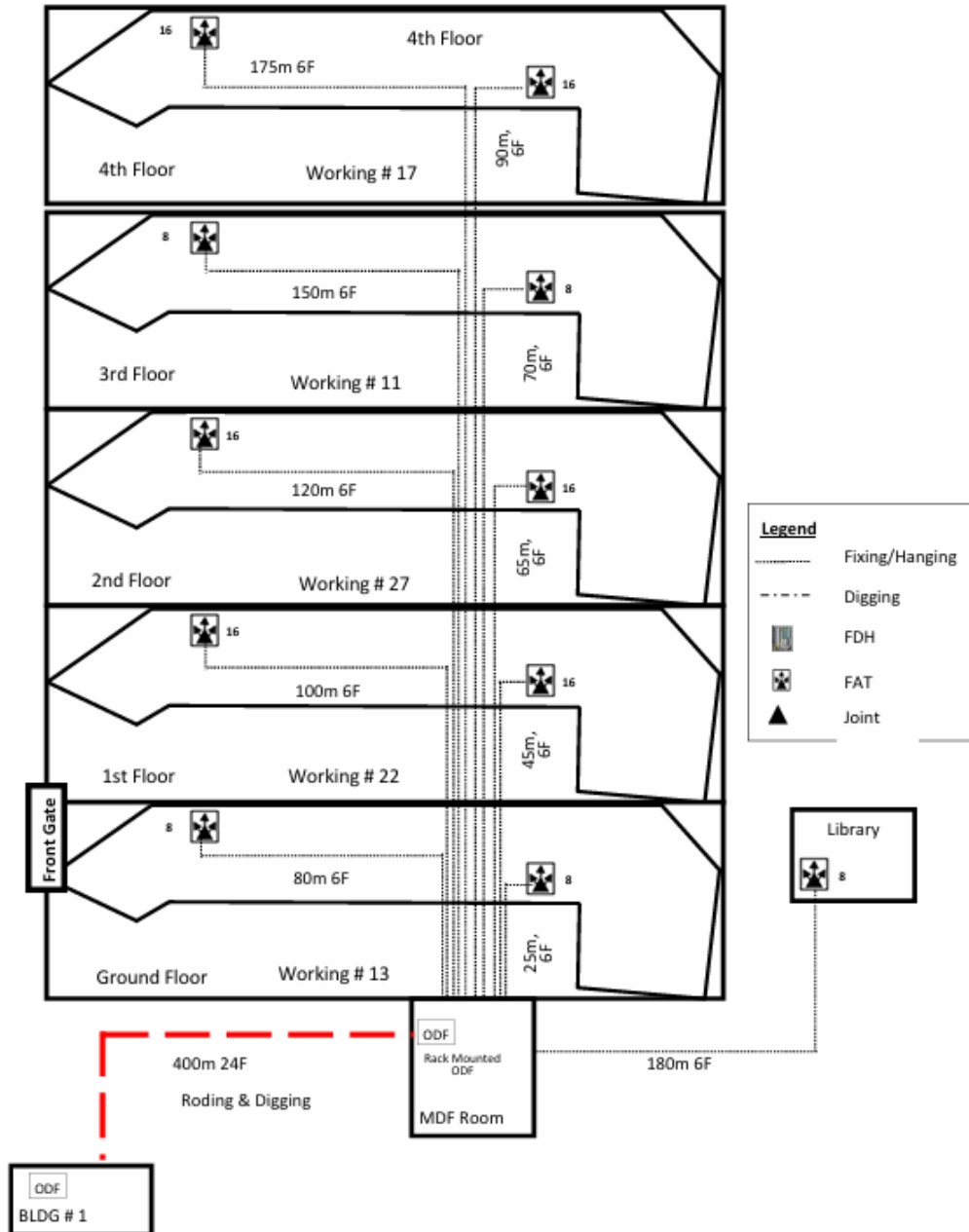

### ANNEX-B-3: LAYOUT DIAGRAM GOVERNOR HOUSE

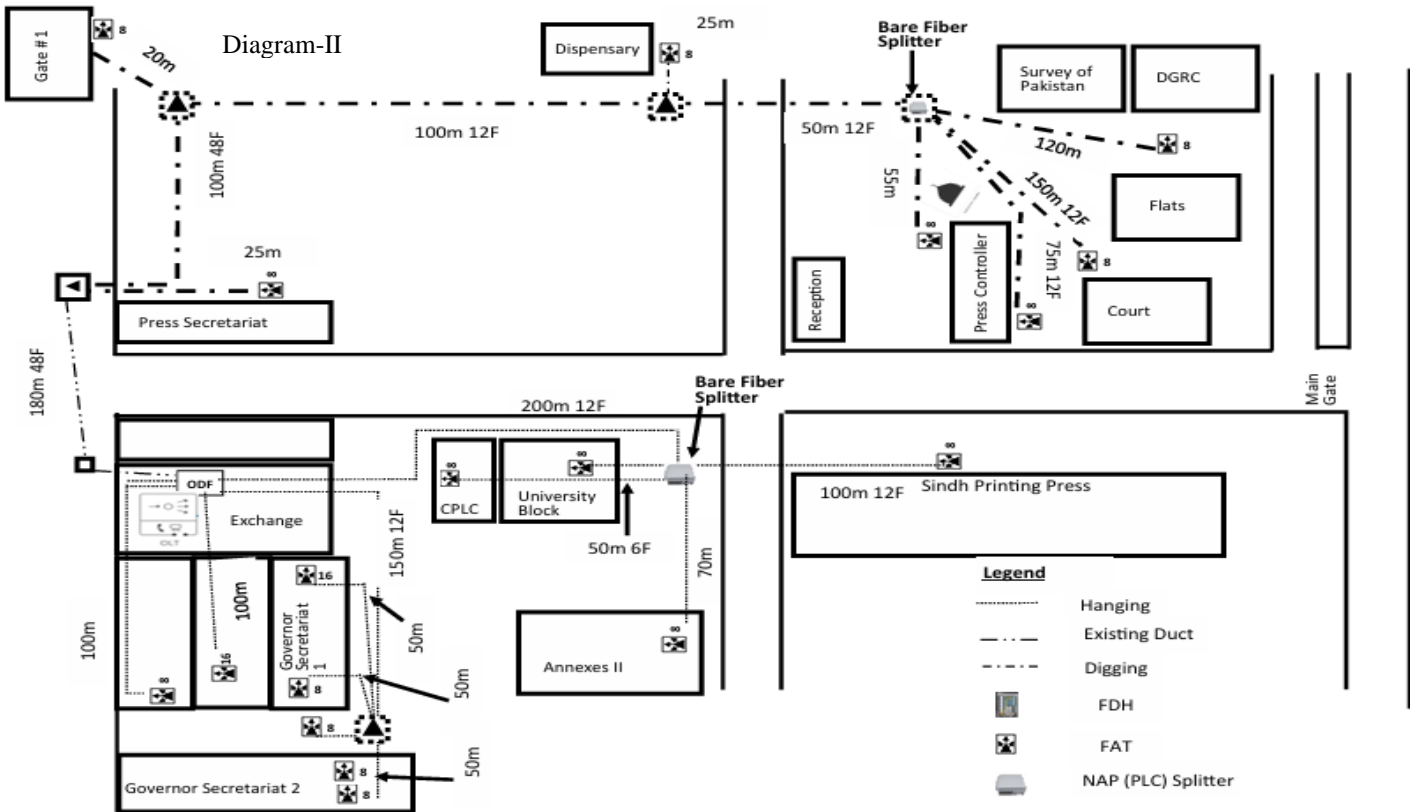
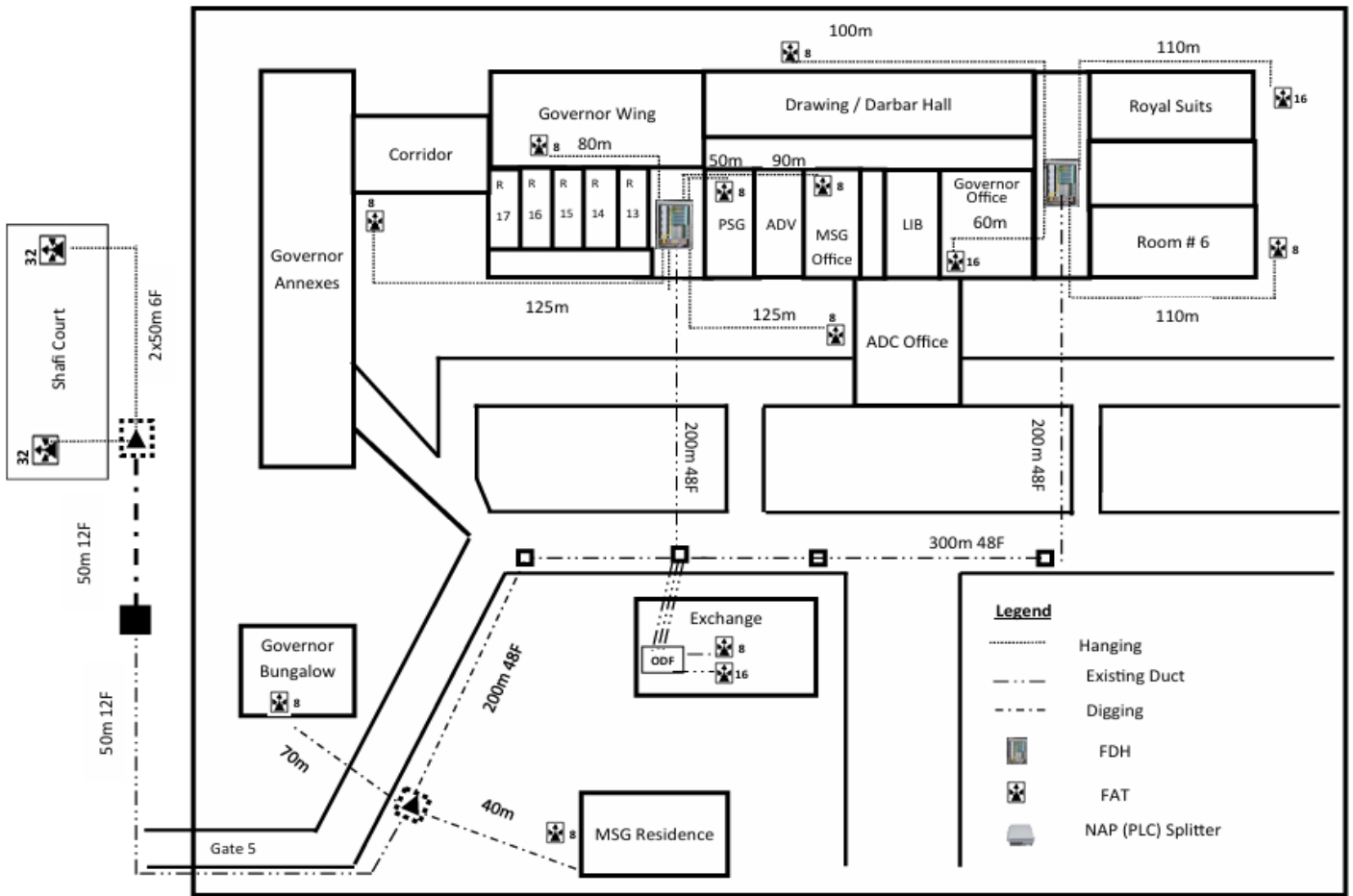

**ANNEX-B-4: LAYOUT DIAGRAM CENTRAL PRISON KARACHI**

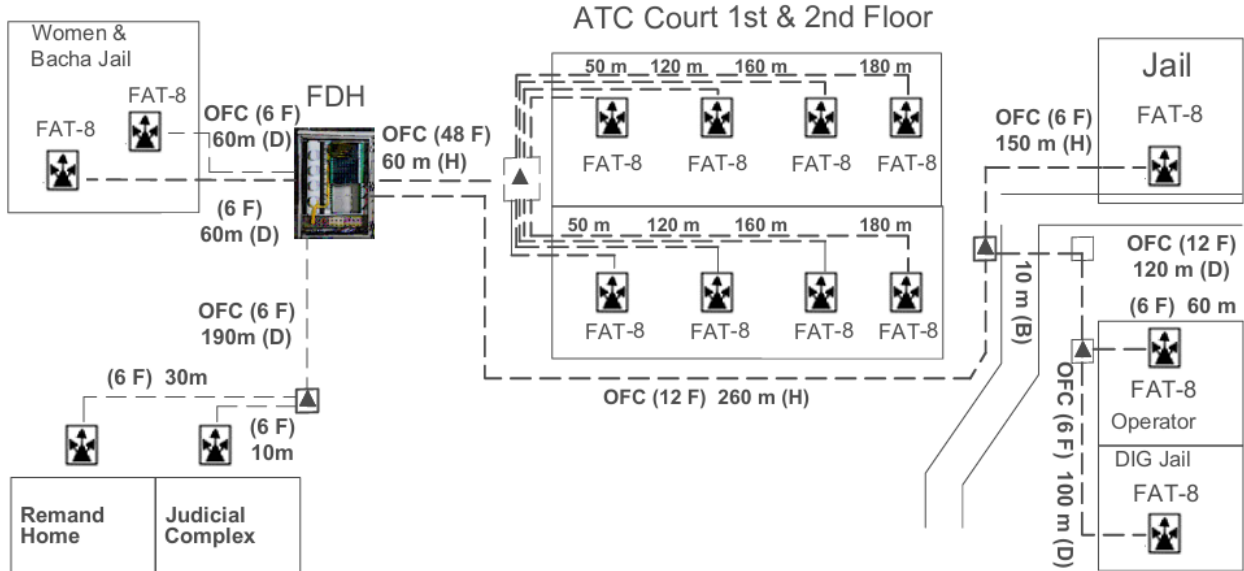

### ANNEX-B-5: LAYOUT DIAGRAM PTV, KARACHI

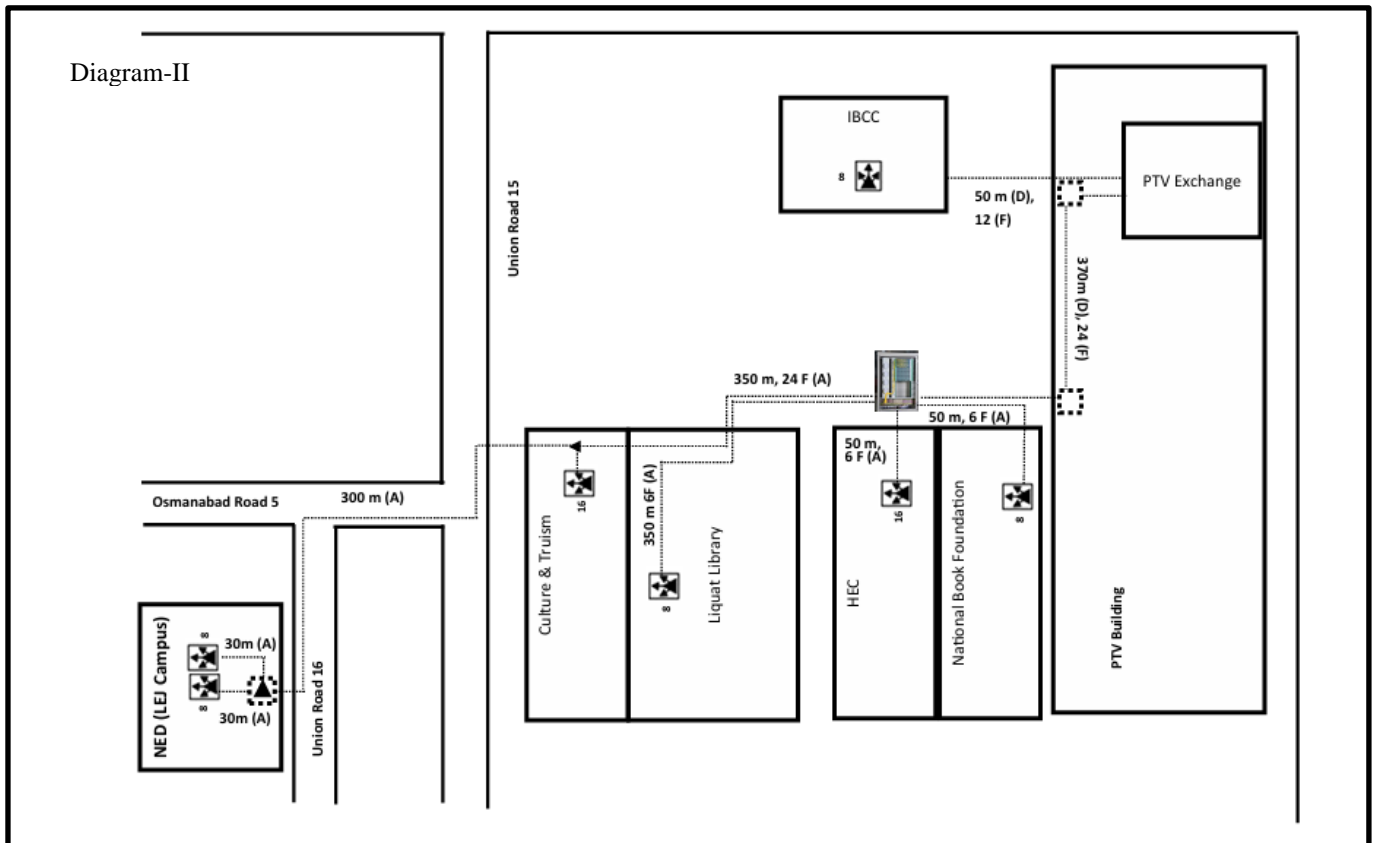
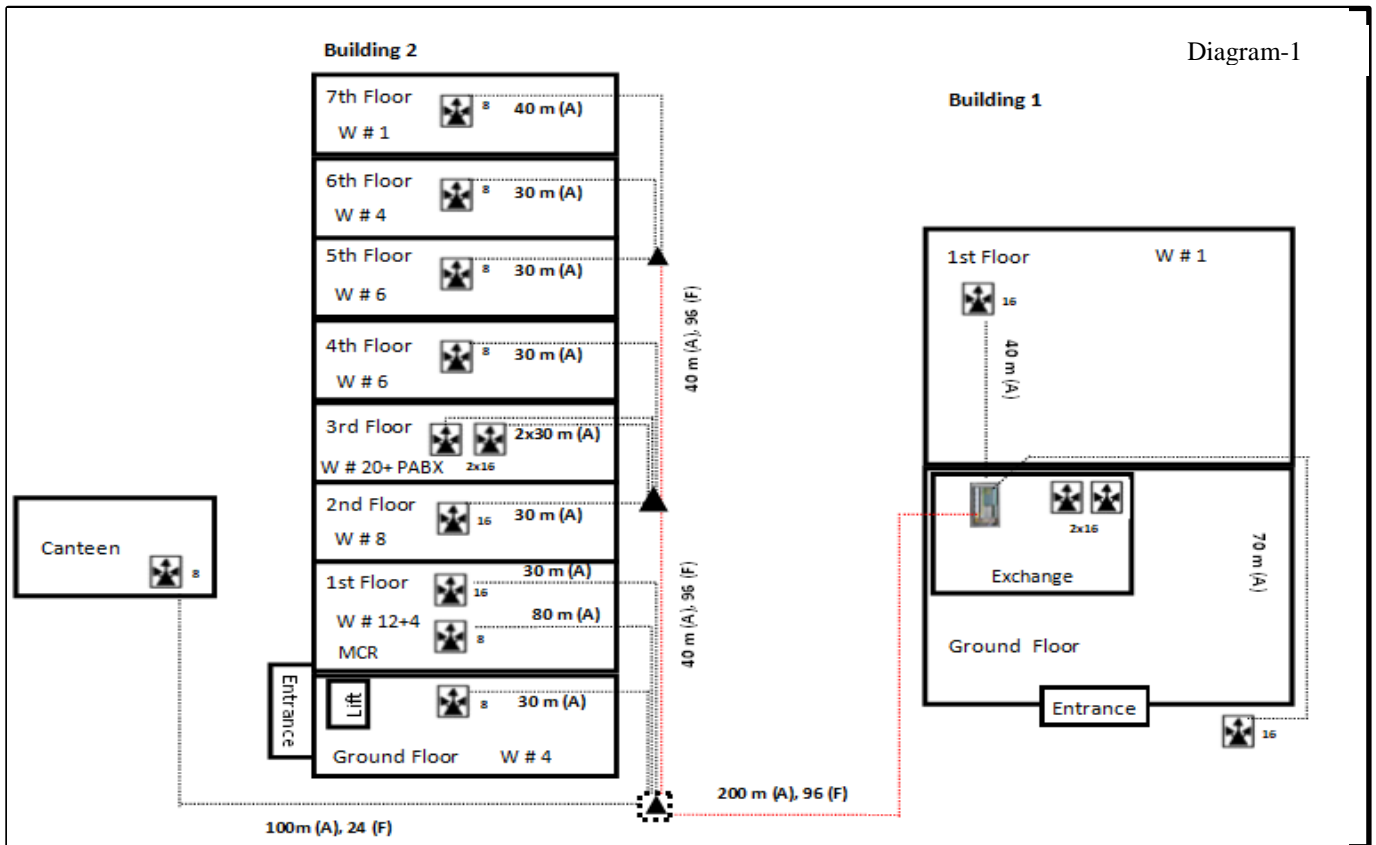

## ANNEX-B-6: LAYOUT DIAGRAM PAK CAPITAL EXCHANGE, KARACHI

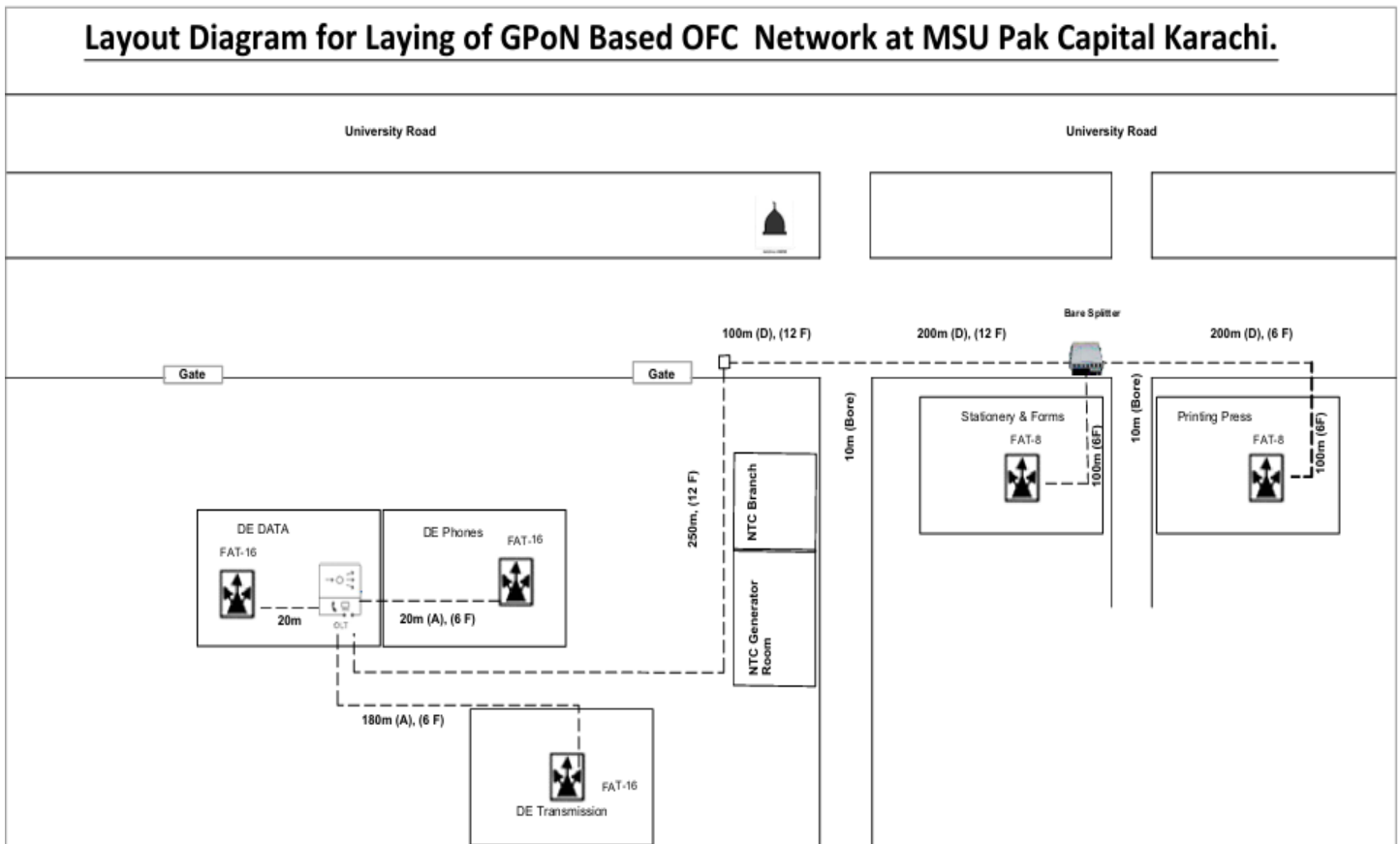

## ANNEX-B-7: LAYOUT DIAGRAM FBR, GULSHAN-e-IQBAL, KARACHI

### Layout Diagram for Laying of GPoN Based OFC Network at FBR 1&2 Gulshan-e-Iqbal Karachi.

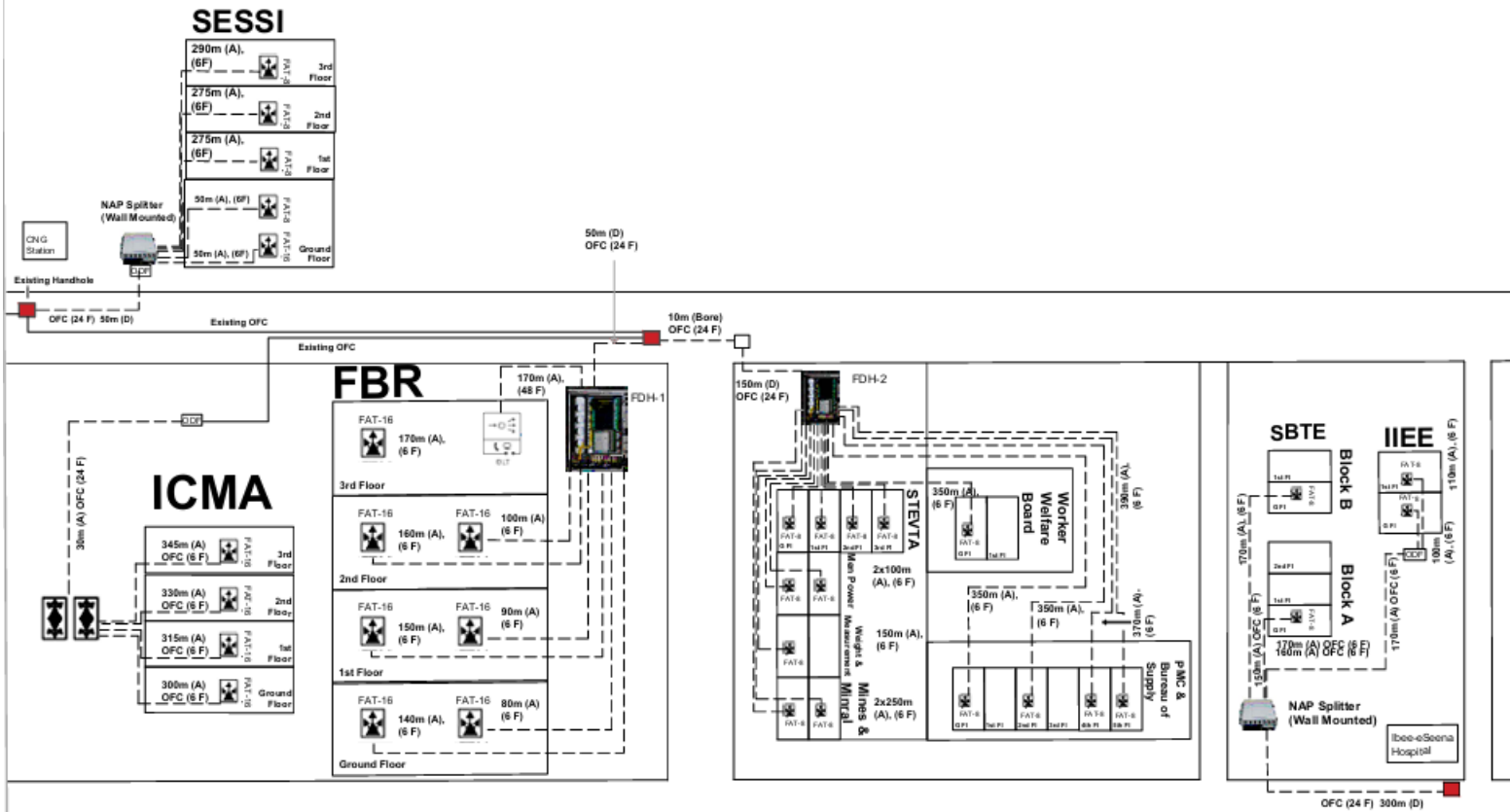

### ANNEX-B-8: LAYOUT DIAGRAM HYDERABAD (Shahbaz Building)

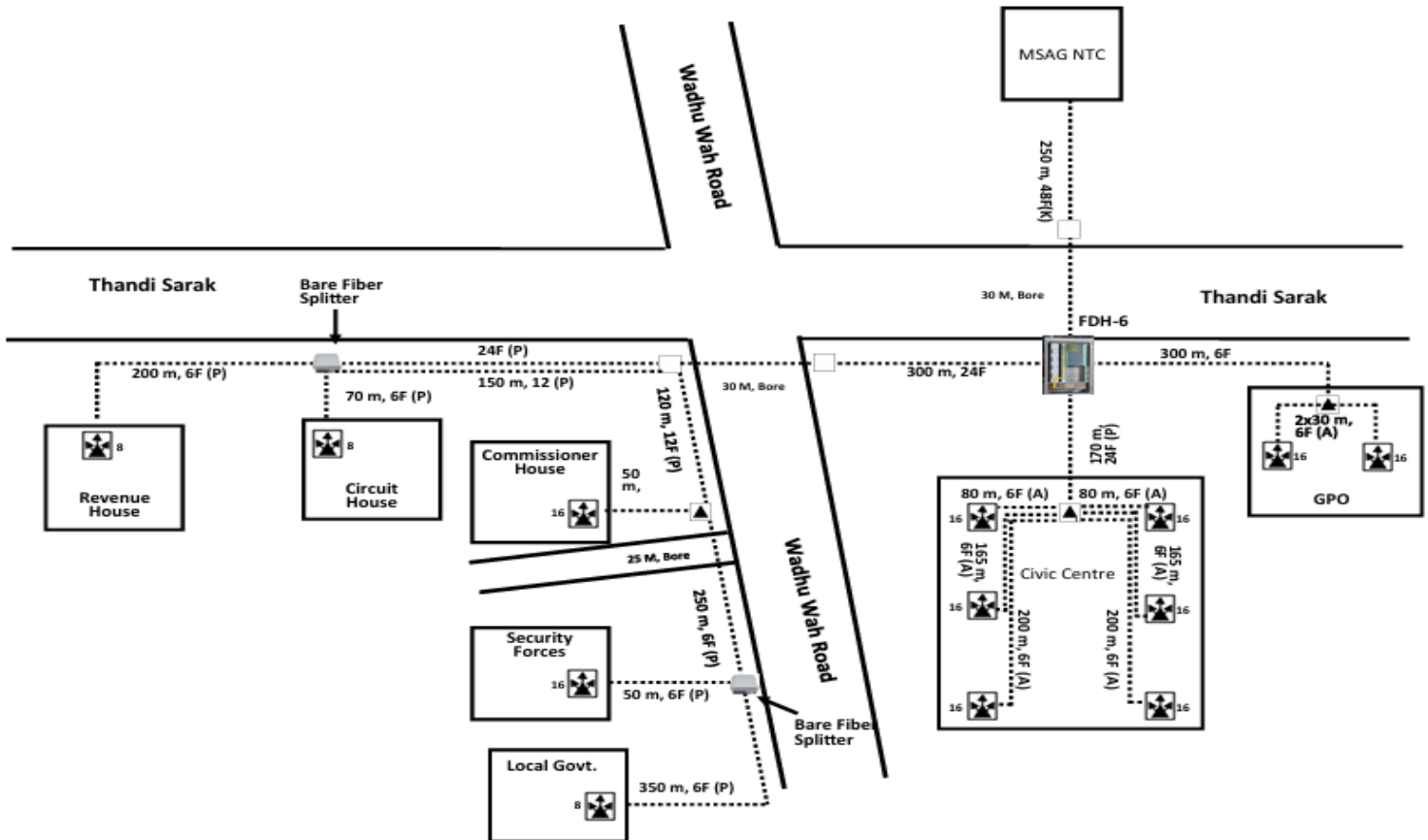
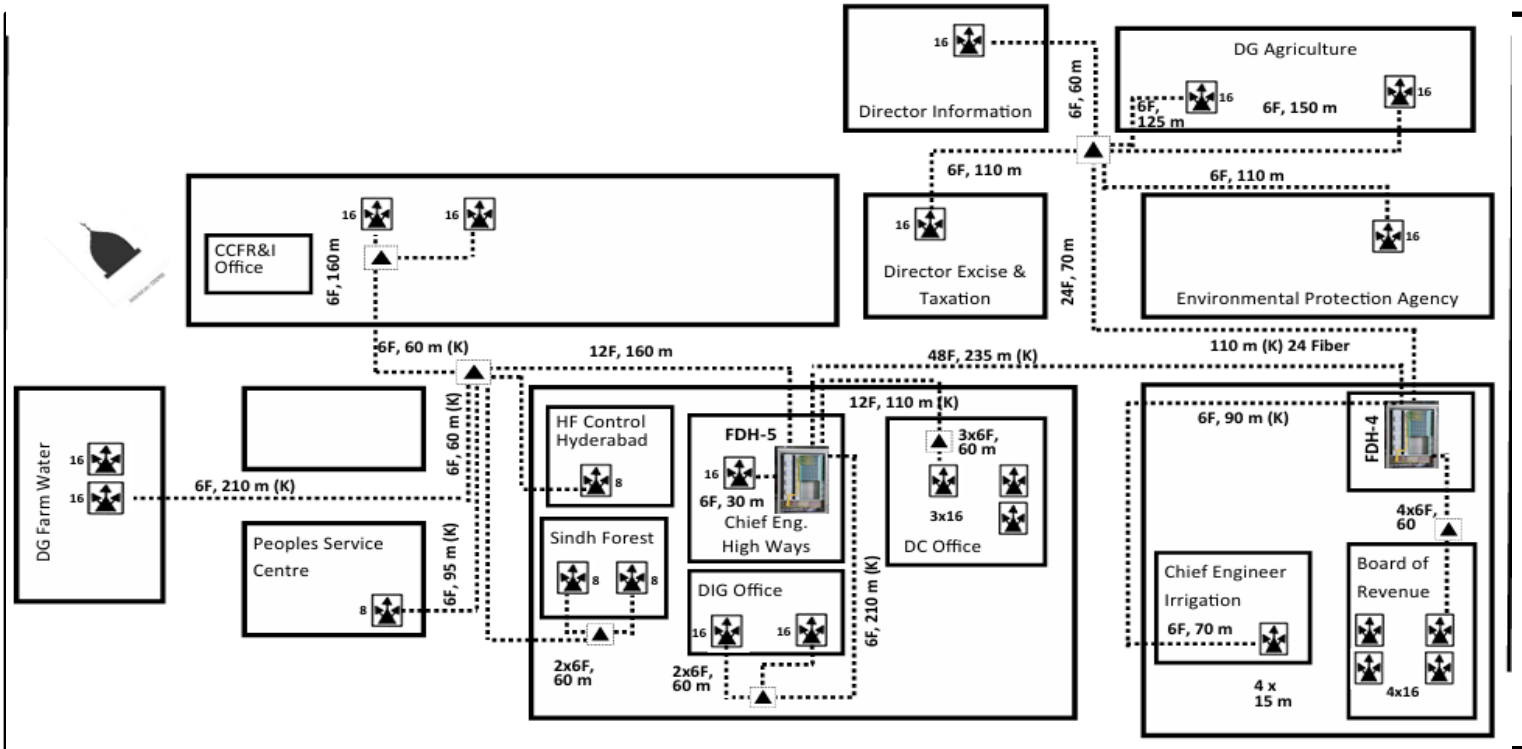

## ANNEX-B-8: LAYOUT DIAGRAM HYDERABAD (DHO)

**Layout Diagram of Optical Fiber Cable Network for GPoN Connectivity from District Health Office (DHO) MSAG at Hyderabad.**

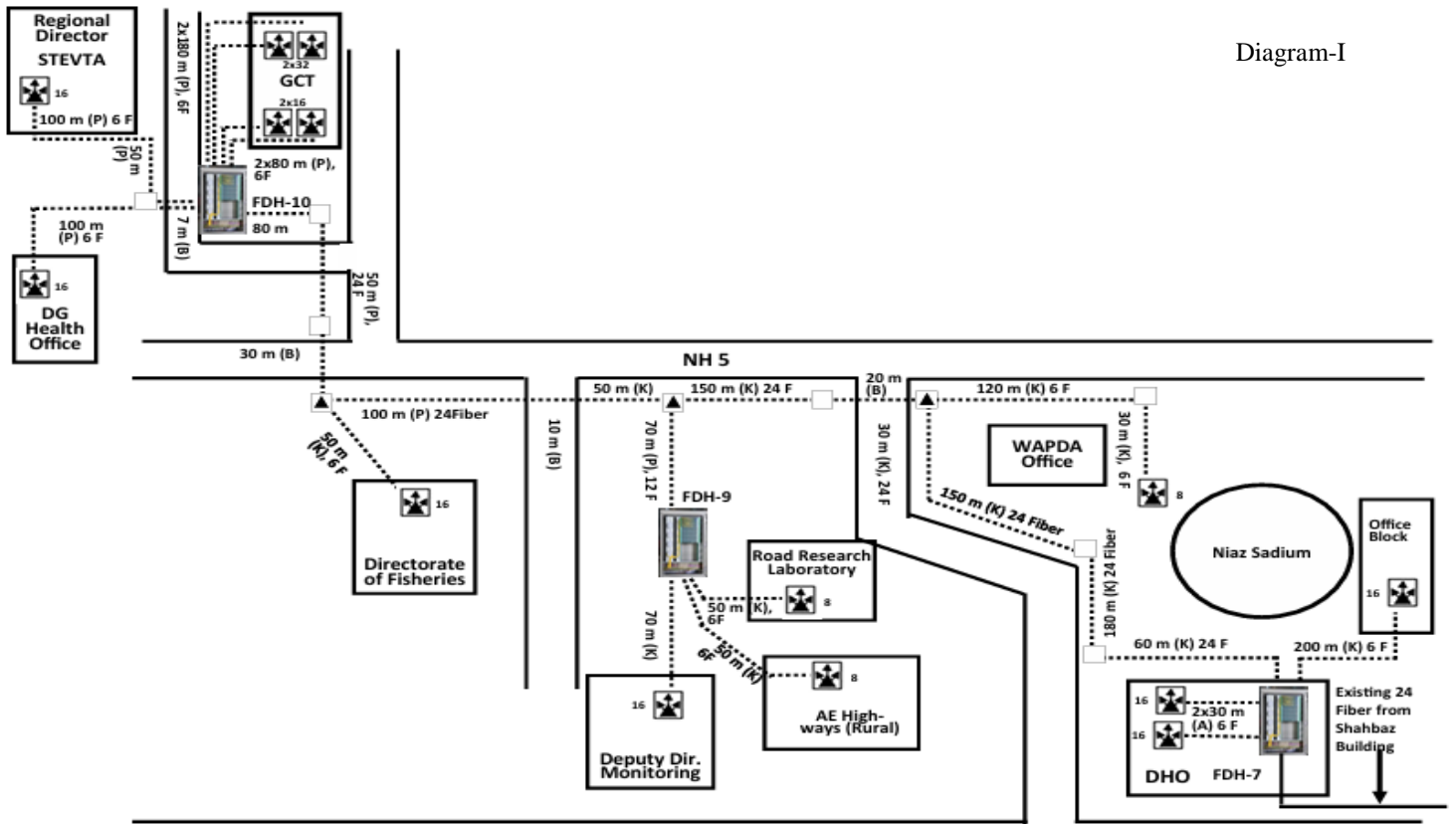
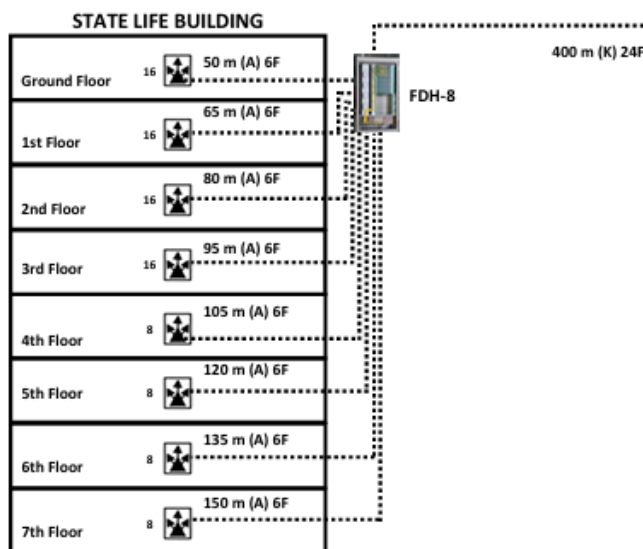
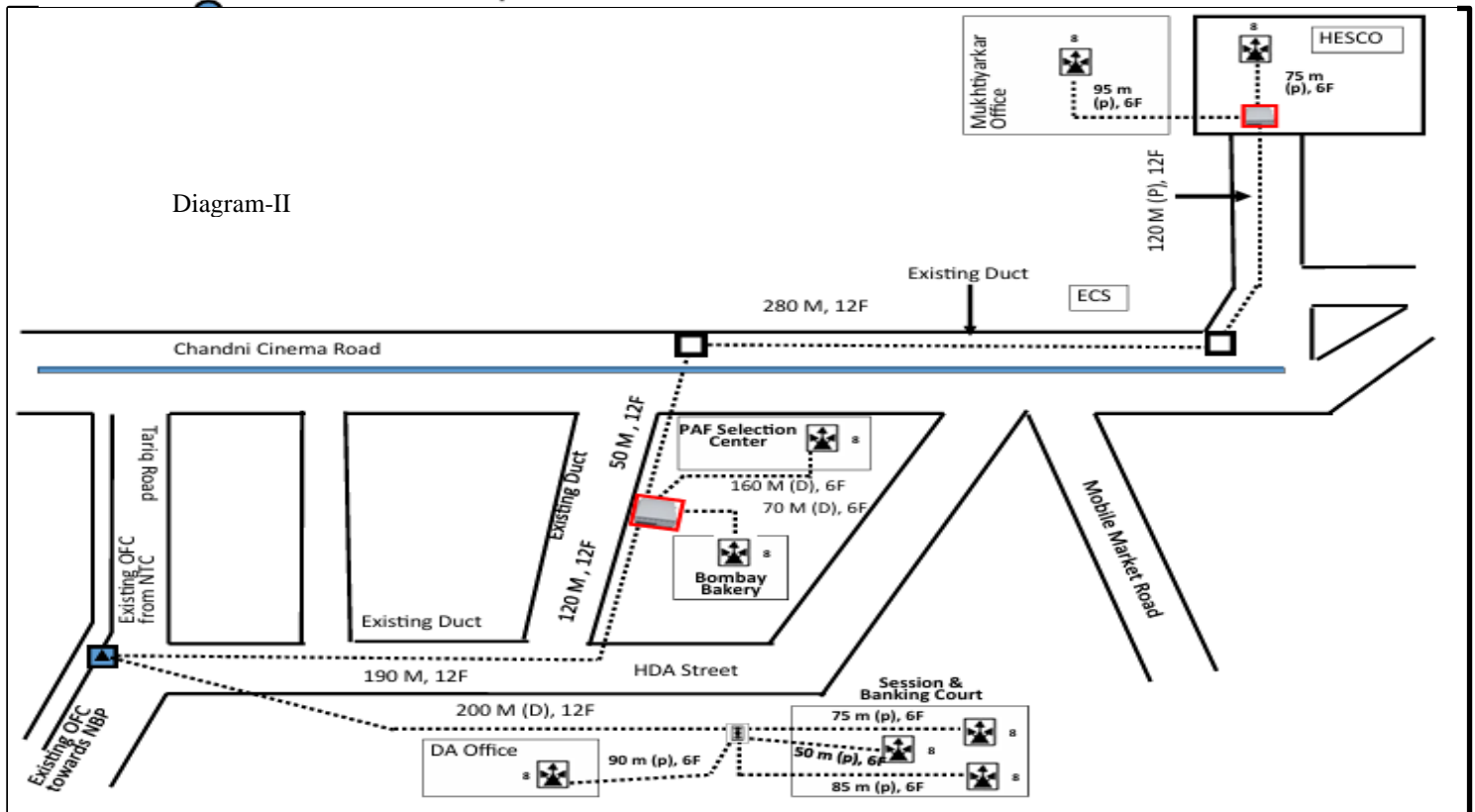
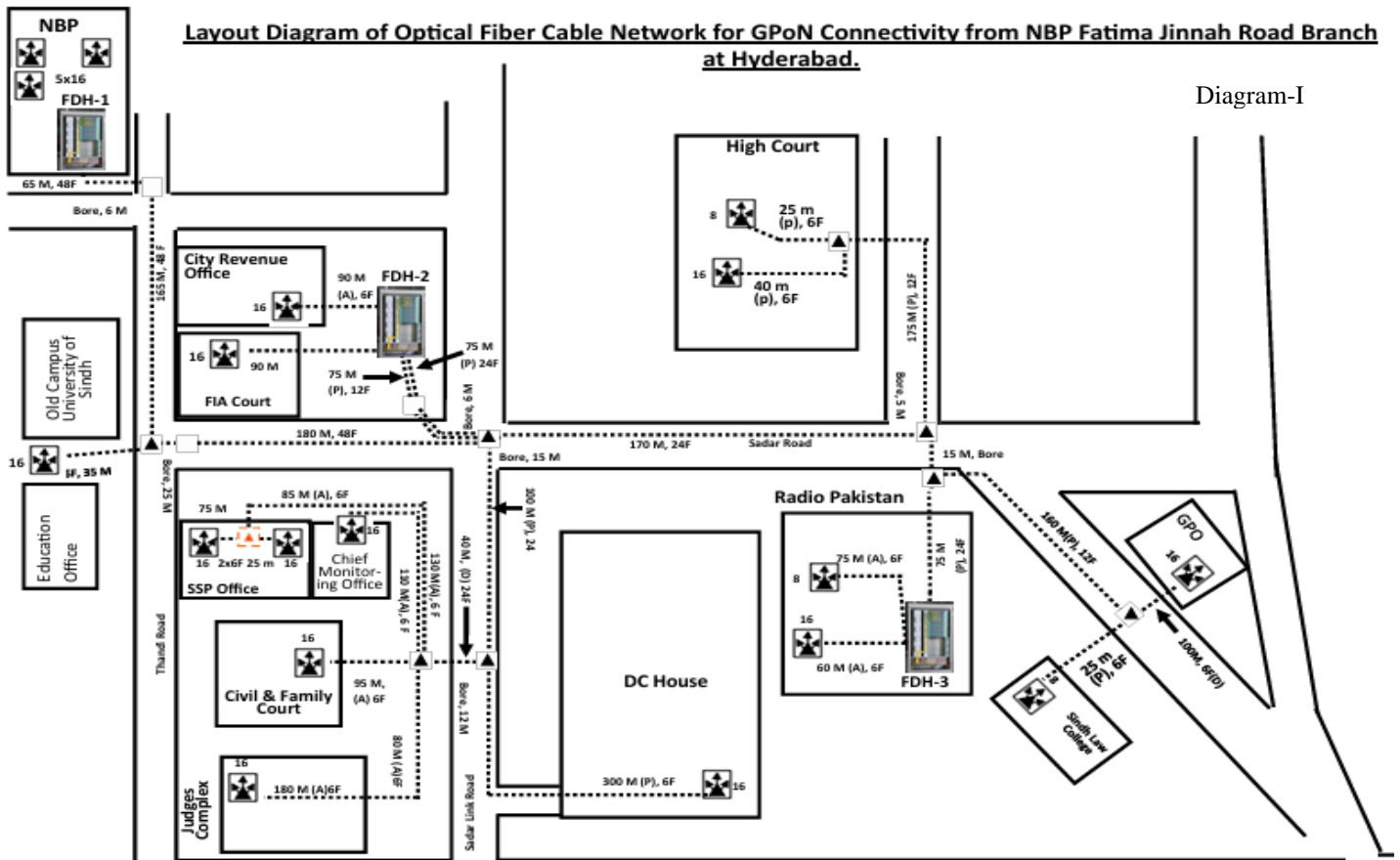

Diagram-I

Diagram-II



### ANNEX-B-8: LAYOUT DIAGRAM HYDERABAD (NBP)



### ANNEX-B-8: LAYOUT DIAGRAM HYDERABAD (MSU HYD)

**Layout Diagram of Optical Fiber Cable Network for GPoN Connectivity from Proposed OLT MSU Hyderabad to Shahbaz Building Hyderabad.** Diagram-I

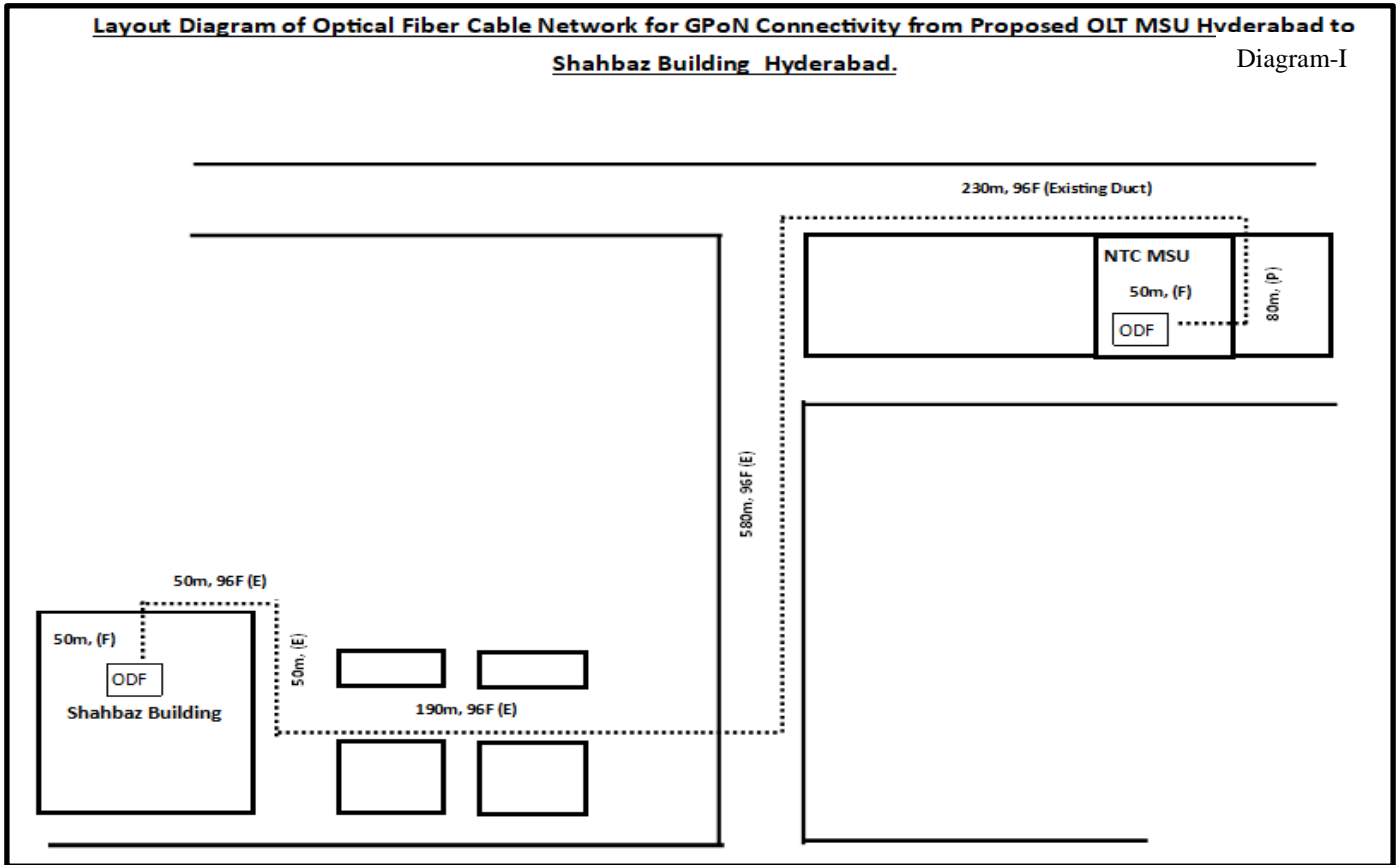

**Optical Fiber Cable from OLT MSU Hyderabad to NBP Hyderabad.** Diagram-II

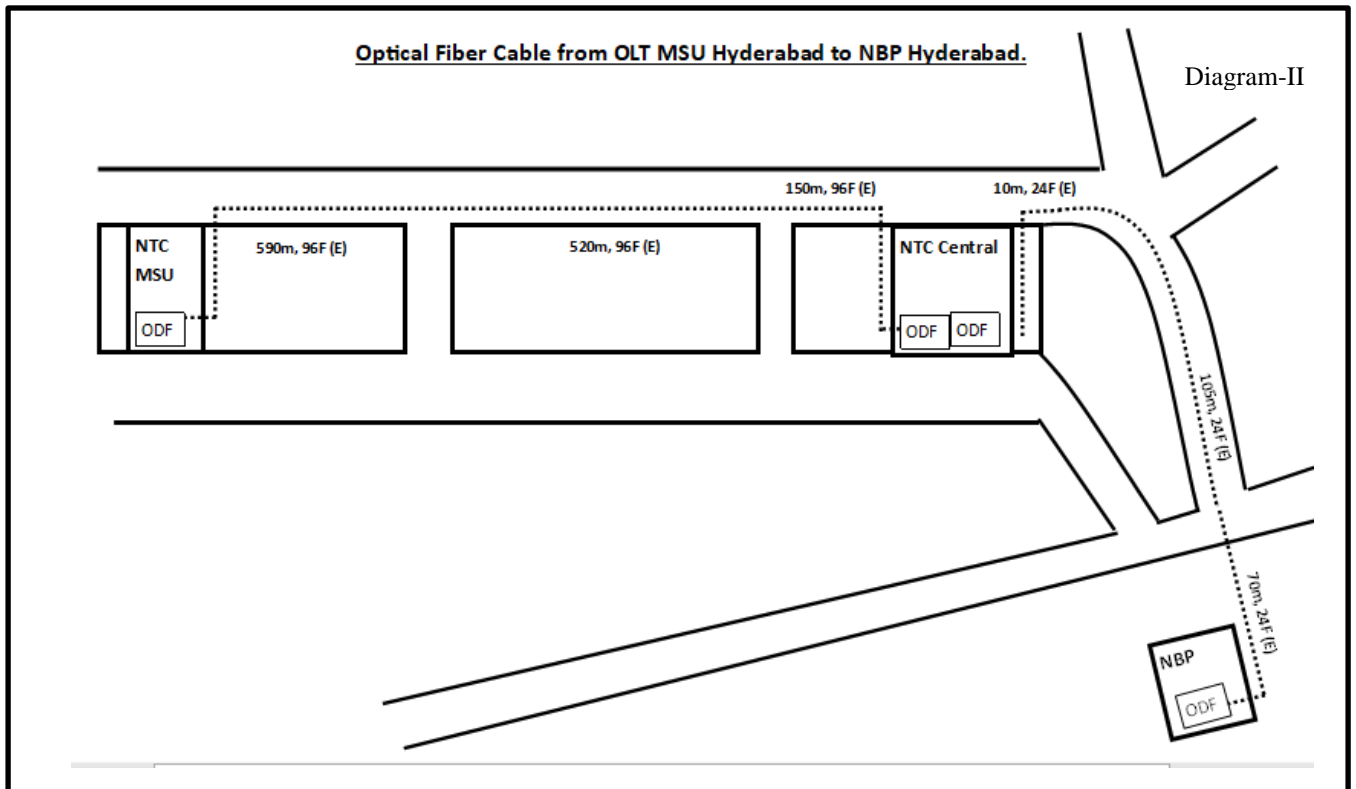

## ANNEX-B-9: LAYOUT DIAGRAM SUJAWAL

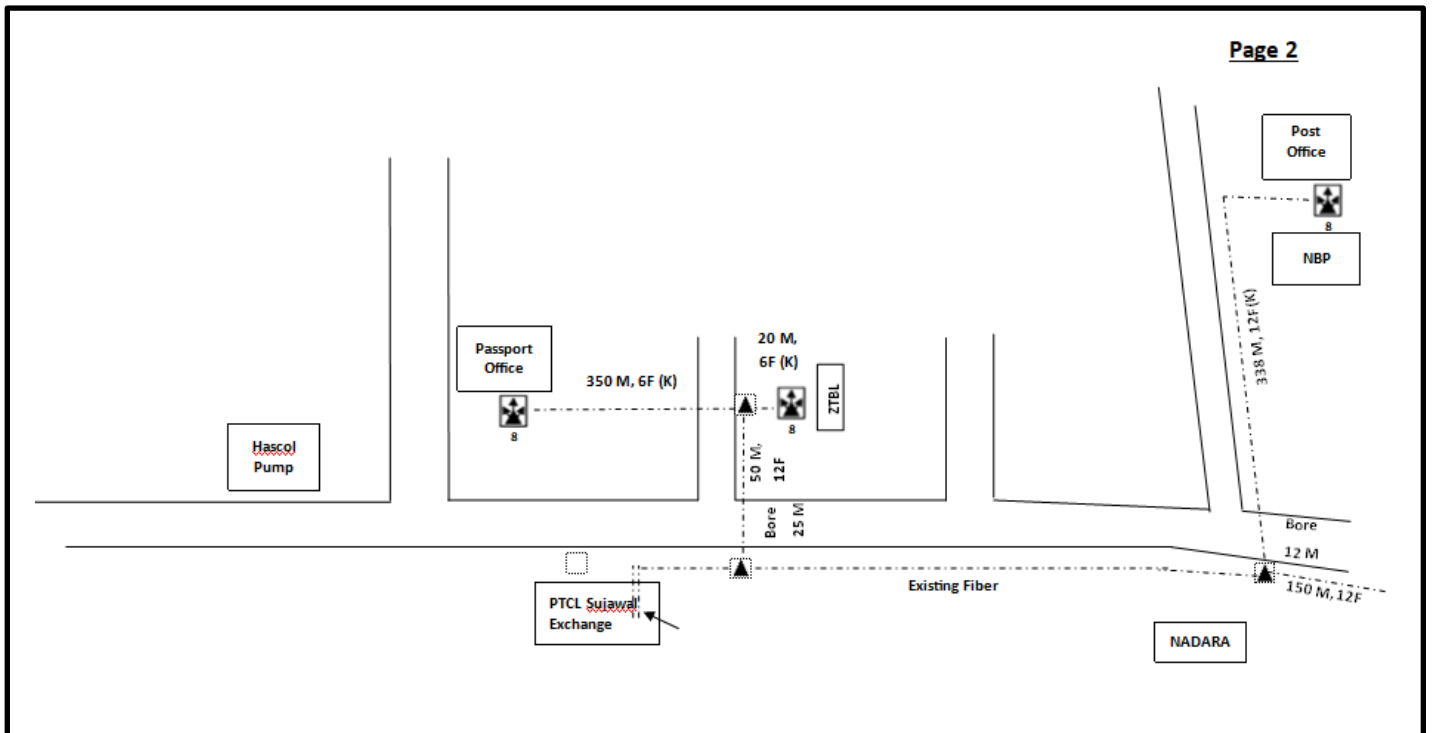
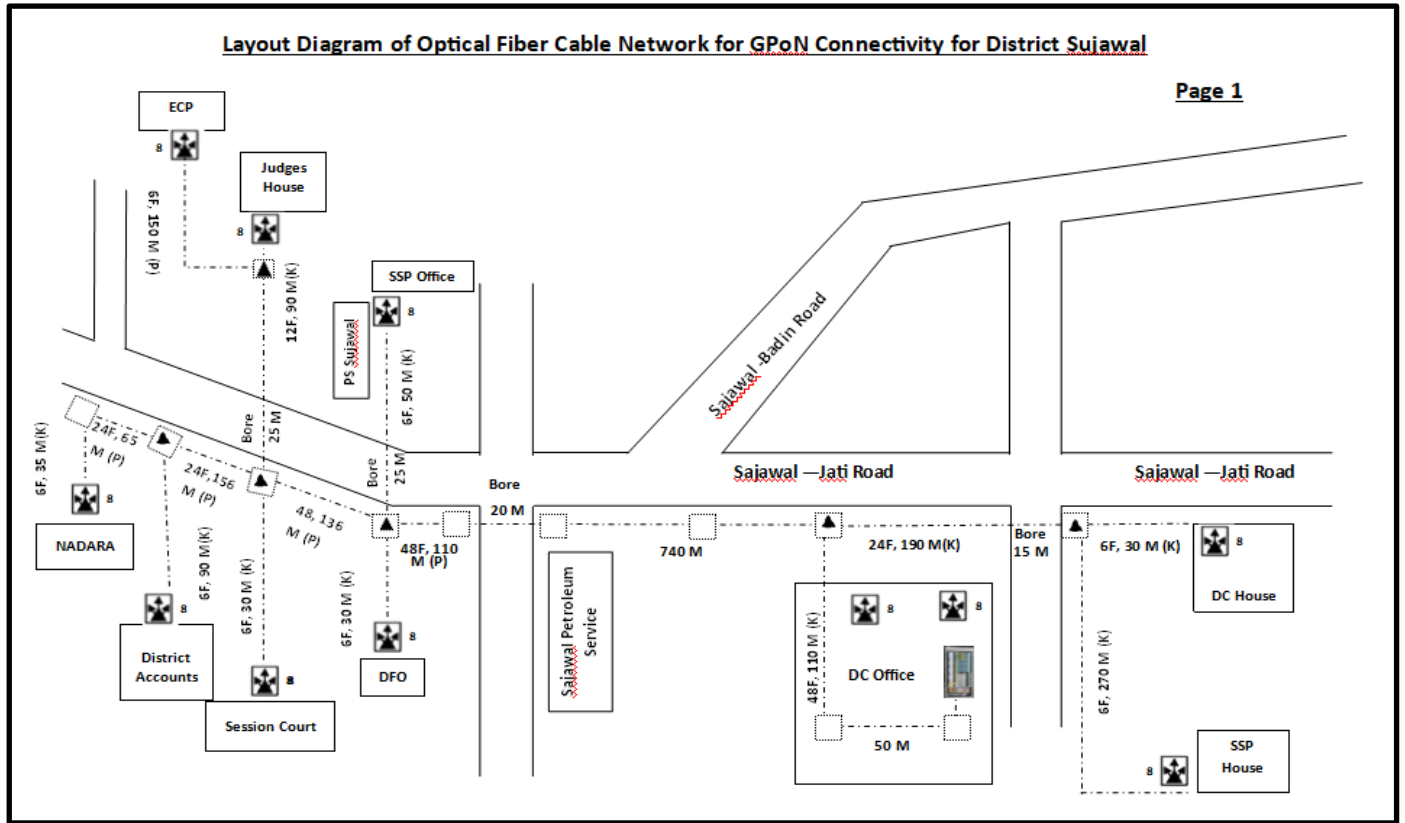

### ANNEX-C: COMMERCIAL COMPLIANCE STATEMENT

Clause #	Description	Complied	Not Complied	Partially complied (give details)	Page # of bid, where compliance available
i	Registration with PEC in category EE07 and EE08				
ii	Registration with tax Authorities				
iii	Having at least 03 x years relevant experience of minimum 03 x Telecommunication works in Pakistan				
iv	Never been black listed				
v	Having established office in Pakistan				
vi	List of employees having at least one registered Telecom/Electronics / Electrical / Computer engineer having 2 years' experience				
vii	The detail of equipment and plants be also provided (Insulation tester, OTDR, splicing machine, route locator and other such equipment essential for execution of laying work).				
viii	The firm must be owned and operated by Pakistani National(s)				

## ANNEX-D: BID SECURITY FORMAT

Bank Guarantee No.-----  
Dated at Karachi, the -----  
Amount \_\_\_\_\_  
Validity \_\_\_\_\_

To,

DIRECTOR Development  
South NTC Karachi

Dear Sir,

WHEREAS M/S \_\_\_\_\_ (hereinafter called the Tenderer) have requested us through \_\_\_\_\_ Bank Ltd., to furnish Bid Security by way of Bank Guarantee in your favour in the sum of \_\_\_\_\_ (IN FIGURE) \_\_\_\_\_ (IN WORDS) against your Tender Notice No. \_\_\_\_\_ dated \_\_\_\_\_ for supply / installation of \_\_\_\_\_.

### WE HEREBY AGREE AND UNDERTAKE:

- i. To make unconditional payment \_\_\_\_\_ to you on demand without further question or reference to the Tenderer in case of withdrawal or modification of bid or any default or non-execution of the Contract or refusal to accept order by the Tenderer from the date of opening of bids until the expiry of the validity of their offer,
- ii. To keep this guarantee in full force from (date) \_\_\_\_\_ upto \_\_\_\_\_ (date) \_\_\_\_\_ the date until which the Tenderer's offer is valid.
- iii. To extend the period of guarantee if such extension be necessary beyond the date stated in para (ii) and as so desired by the tenderer.

Any claim arising out of this guarantee must be lodged with this Bank within the period the guarantee is valid and before the date of its expiry. After this date the guarantee will be considered null and void and should be returned to us.

Yours faithfully,

Name of the Bank: \_\_\_\_\_  
Authorized officer's Signature & Seal: \_\_\_\_\_

## ANNEX-E: PERFORMANCE BOND FORMAT

Bank Guarantee No. -----  
Date of Issue -----  
Valid upto -----  
Value (Rs.) -----

FROM: \_\_\_\_\_  
\_\_\_\_\_

TO,  
DIRECTOR DEVELOPMENT SOUTH,  
NTC KARACHI

SUBJECT: B/G AND DATE FOR \_\_\_\_\_ ON BEHALF OF \_\_\_\_\_ FOR DUE  
AND FAITHFUL PERFORMANCE ORDER NO. \_\_\_\_\_  
DATED \_\_\_\_\_.

Whereas M/s \_\_\_\_\_ (hereinafter called the Supplier) have requested us to furnish a Bank Guarantee in your favour in the sum \_\_\_\_\_ (IN WORDS) \_\_\_\_\_ as performance security against order No. \_\_\_\_\_ dated \_\_\_\_\_ to be concluded between the Supplier and Office of the Director Development South National Telecommunication Corporation, Malir Halt Karachi.

WE HEREBY AGREE:

- 1). To make an un-conditional payment of \_\_\_\_\_ to you on demand without any further question or reference to the Supplier upon failure of the Supplier to perform the Order for which you will be the sole judge.
- 2). To keep this guarantee valid in full force from this date upto the time of the due and faithful completion of the Order under reference (the schedule of implementation shall be as described in the Purchase order and its subsequent amendments) or till \_\_\_\_\_ whichever date is later. The faithful completion of the order by the Supplier will be intimated by the NTC.
- 3). To extend the period of the enforceability of this guarantee if such extension be necessary or desired by you of us. All claims thereunder must be submitted to the Bank of \_\_\_\_\_ on or before the expiry date mentioned in this guarantee are the date mentioned in its extensions issued from time to time, after which this guarantee will become null and void and should be returned to us. Irrespective of its return, we shall consider ourselves fully discharged from any obligation there under after the said expiry date.

Dated This Day of \_\_\_\_\_

Authorized Signature: \_\_\_\_\_  
& Seal of bank

Witness: \_\_\_\_\_

Sworn & Sign before me  
this day of.... ..  
by. \_\_\_\_\_

## ANNEX-F: DECLARATION OF BENEFICIAL OWNER INFORMATION

### Declaration of Ultimate Beneficial Owners Information for Public Procurement Contracts

1. Name
2. Father's Name/Spouse's Name
3. CNIC/NICOP/Passport no.
4. Nationality
5. Residential address
6. Email address
7. Date on which shareholding, control or interest acquired in the business.
8. In case of indirect shareholding, control or interest being exercised through intermediary companies, entities or other legal persons or legal arrangements in the chain of ownership or control, following additional particulars to be provided:

1	2	3	4	5	6	7	8	9	10
Name	Legal form (Company/Limited Liability Partnership/Association of Persons/Single Member Company/ Partnership Firm/ Trust/Any other individual, body corporate (to be specified))	Date of incorporation / registration	Name of registering authority	Business Address	Country	Email address	Percentage of shareholding, control or interest of BO in the legal person or legal arrangement	Percentage of shareholding, control or interest of legal person or legal arrangement in the Company	Identity of Natural Person who ultimately owns or controls the legal person or arrangement

9. Information about the Board of Directors (details shall be provided regarding number of shares in the capital of the company as set opposite respective names).

1	2	3	4	5	6	7	8
Name and surname (In Block Letters)	CNIC No. (in case of foreigner, Passport No)	Father's/ Husband's Name in full	Current Nationality	Any other Nationality (ies)	Occupation	Residential address in full or the registered/ principal office address for a subscriber other than natural person	Number of shares taken by each subscriber (in figures and words)
			Total number of shares taken (in figures and words)				

10. Any other information incidental to or relevant to Beneficial Owner(s).

Name & signature

(Person authorized to issue notice on behalf of the company)